



JOSEPH P. VIOLA  
Vice President  
Regulatory Affairs

August 26, 2014

FILED

2014 AUG 26 P 4:10

PUBLIC UTILITIES  
COMMISSION

The Honorable Chair and Members of the  
Hawai'i Public Utilities Commission  
465 South King Street  
Kekuanaoa Building, 1st Floor  
Honolulu, Hawai'i 96813

Dear Commissioners:

Subject: Docket No. 2011-0206 – Reliability Standards Working Group  
Hawaiian Electric Companies' Distributed Generation Interconnection Plan

The Hawaiian Electric Companies<sup>1</sup> hereby submit their Distributed Generation Interconnection Plan (“DGIP”).

The DGIP is one of a series of plans and reports ordered by the Hawai'i Public Utilities Commission (“Commission”) in four orders filed on April 28, 2014.<sup>2</sup> As the Commission observed in one of those orders, Hawai'i's electric utilities lead the nation in the integration of residential rooftop solar photovoltaic (“PV”) systems. As a result, they “are at the forefront of the interconnection challenges associated with high distribution circuit penetration levels” and Hawai'i will, by necessity, lead the way in solving the challenges associated with high amounts of distributed generation (“DG”).<sup>3</sup> The Commission also cautioned that it is unrealistic to expect the recent high growth rate in distributed solar PV (“DG PV”) capacity additions to be sustainable “in the same technical, economic, and policy manner in which it occurred, particularly when electric energy usage is declining, distribution circuit penetration levels are increasing, system-level challenges are emerging, and grid fixed costs are increasingly being shifted to non-solar customers.”<sup>4</sup>

The Companies' DGIP addresses these challenges and provides strategies and actions that will increase DG capacity on their systems while preserving system reliability. Together with the improvements identified in the Companies' Power Supply Improvement Plans (“PSIPs”) filed

---

<sup>1</sup> The “Hawaiian Electric Companies” or “Companies” are Hawaiian Electric Company, Inc., Hawai'i Electric Light Company, Inc., and Maui Electric Company, Limited.

<sup>2</sup> In addition to the DGIP, the April 28 D&Os required the Companies to file several other plans and reports, including Power Supply Improvement Plans; a Plan to implement an on-going distribution circuit monitoring program; an Action Plan for improving efficiencies in the interconnection requirements studies; a Proposal to implement an integrated interconnection queue for each distribution circuit for each island grid; an integrated Demand Response Portfolio Plan that will enhance system operations and reduce costs to customers.

<sup>3</sup> Order No. 32053, Ruling on RSWG Work Product, filed April 28, 2014 in Docket No. 2011-0206 at page 32.

<sup>4</sup> Id. at 49.

today, these initiatives will nearly *triple* the amount of DG PV that can be installed across our service territories in the future.

The DGIP approach is grounded in four basic principles:

- Policies should lead to a sustainable set of customer options for DG;
- The Companies must be proactive in responding to customer demand for DG;
- All initiatives must ensure the safety and reliability of the grid for all customers; and
- Rates governing DG interconnections must fairly reflect the value of the power provided from and to the grid, and must fairly allocate costs of the grid to all customers.

To address technical and system security challenges, the DGIP outlines specific circuit upgrades required to enable higher levels of DG penetration in a proactive manner, and plans to implement advanced inverters and other technologies, including elements of the modernized grid, to maintain safe and reliable service.

Regulatory and policy reform are essential to ensure that the incentives for future DG interconnections are aligned with the interests of all customers. To that end, the DGIP describes policies that better reflect the value of DG to the grid, and the value of the grid to DG customers. In the short term, these policies entail:

- Clearing the existing queue of DG projects (including Net Energy Metering (“NEM”) program applications) as circuit and system-level constraints allow; and
- Transitioning the NEM program (while revised DG tariffs are being developed - as discussed below) to an approach governed by a modified “Schedule Q” tariff (similar to the process utilized by Kaua‘i Island Utility Cooperative) along with a non-export option.

In parallel, in the newly opened Distributed Energy Resources docket,<sup>5</sup> the Companies will seek to establish a revised set of DG tariffs as part of an approach to distributed generation called “DG 2.0.” Under revised tariff structures, DG 2.0 will enable the interconnection of DG systems in a manner that fairly allocates costs among all customers and appropriately compensates DG providers.

In keeping with the Companies’ commitment to enable DG growth in a fair and sustainable manner, the DGIP also introduces new products and services that expand customer options for DG. These offerings will include multiple ways of accessing DG resources—including export and non-export systems and community solar—to maximize the benefits of DG across all customers.

While the DGIP is a significant step forward, it is not a final step. The Companies acknowledge that the DGIP is part of an on-going public dialogue and plans and strategies need to be flexible.

---

<sup>5</sup> On August 22, 2014, the Commission filed Order No. 32269 “Instituting a Proceeding to Investigate Distributed Energy Resource Policies” in Docket No. 2014-0192.

The Honorable Chair and Members of  
the Hawai'i Public Utilities Commission  
August 26, 2014  
Page 3

Likewise, the DGIP, PSIPs and the other plans and reports filed in response to the April 28 D&Os are parts of an overall strategy to continue the transition of Hawai'i and the Hawaiian Electric Companies to a clean energy future.

The Companies' vision for the future is to deliver cost-effective, clean, reliable, and innovative energy services to our customers, creating meaningful benefits for Hawai'i's economy and environment, and making Hawai'i a leader in the nation's energy transformation. The Companies foresee a transformation of Hawaii's electric system that will result in:

- A reduction in full service residential customer bills of more than 20% by 2030;
- On a consolidated basis, more than 65% of the Companies' energy being provided by renewable energy resources by 2030;
- Distributed energy resources, such as rooftop solar and demand response, playing an even greater role in our energy resource portfolio;
- Lower cost, cleaner fuels such as liquefied natural gas (LNG) largely replacing the remaining use of expensive imported oil;
- Development of a state-of-the-art energy delivery system (the grid) as the platform for the new energy portfolio and customer options; and
- More options to meet customers' changing energy needs and preferences.

Achieving this vision will require an innovative and transformative utility whose business, regulatory and operating models are all aligned. In this dynamic environment, no single party can realize this future for Hawai'i or determine the utility model that best serves customers. For this reason, the Companies seek a shared vision for Hawai'i's energy future with our customers, stakeholders, regulators, and policy makers.

Very truly yours,



Joseph P. Viola  
Vice President  
Regulatory Affairs  
Hawaiian Electric Company, Inc.

Vice President  
Hawai'i Electric Light Company, Inc.  
Maui Electric Company, Limited

Enclosure

cc: Service List

SERVICE LIST  
(Docket No. 2011-0206)

JEFFREY T. ONO EXECUTIVE DIRECTOR DEPARTMENT OF COMMERCE AND CONSUMER AFFAIRS DIVISION OF CONSUMER ADVOCACY P.O. Box 541 Honolulu, HI 96809	2 Copies Via Hand Delivery
GREGG J. KINKLEY, ESQ. DEPARTMENT OF THE ATTORNEY GENERAL 425 Queen Street Honolulu, Hawaii 96813 Counsel for DBEDT	1 Copy Electronically Transmitted
DANIEL W.S. LAWRENCE, ESQ. DEPARTMENT OF THE CORPORATION COUNSEL CITY AND COUNTY OF HONOLULU 530 S. King Street, Room 110 Honolulu, HI 96813 Counsel for the CITY AND COUNTY OF HONOLULU	1 Copy Electronically Transmitted
LINCOLN S.T. ASHIDA, ESQ. WILLIAM V. BRILHANTE, JR., ESQ. MICHAEL J. UDOVIC, ESQ. DEPARTMENT OF THE CORPORATION COUNSEL COUNTY OF HAWAII 101 Aupuni Street, Suite 325 Hilo, HI 96720 Counsel for the COUNTY OF HAWAII	1 Copy Electronically Transmitted
HENRY Q CURTIS VICE PRESIDENT FOR CONSUMER ISSUES LIFE OF THE LAND P.O. Box 37158 Honolulu, HI 96837-0158	1 Copy Electronically Transmitted
WARREN S. BOLLMEIER II PRESIDENT HAWAII RENEWABLE ENERGY ALLIANCE 46-040 Konane Place, #3816 Kaneohe, HI 96744	1 Copy Electronically Transmitted

SERVICE LIST  
(Docket No. 2011-0206)

DOUGLAS A. CODIGA, ESQ.  
SCHLACK ITO LLLC  
Topa Financial Center  
745 Fort Street, Suite 1500  
Honolulu, HI 96813  
Counsel for BLUE PLANET FOUNDATION

1 Copy  
Electronically Transmitted

ISAAC MORIWAKE, ESQ.  
DAVID HENKIN, ESQ.  
EARTHJUSTICE  
850 Richards Street, Suite 400  
Honolulu, HI 96813-4501  
Counsel for HAWAII SOLAR ENERGY ASSOCIATION

1 Copy  
Electronically Transmitted

KENT D. MORIHARA, ESQ.  
KRIS N. NAKAGAWA, ESQ.  
LAUREN M. IMADA-LEE, ESQ.  
TANYA M. FERNANDES, ESQ.  
Morihara Lau & Fong LLP  
841 Bishop Street, Suite 400  
Honolulu, Hawaii 96813  
Counsel for KAUAI ISLAND UTILITY COOPERATIVE

1 Copy  
Electronically Transmitted

ERIK W. KVAM  
CHIEF EXECUTIVE OFFICER  
ZERO EMISSIONS LEASING LLC  
1110 University Avenue, Suite 402  
Honolulu, HI 96826

1 Copy  
Electronically Transmitted

SANDRA-ANN Y.H. WONG, ESQ.  
ATTORNEY AT LAW, A LAW CORPORATION  
1050 Bishop Street, #514  
Honolulu, HI 96813  
Counsel for TAWHIRI POWER LLC

1 Copy  
Electronically Transmitted

RILEY SAITO  
73-1294 Awakea Street  
Kailua-Kona, HI 96740  
For SOLAR ENERGY INDUSTRIES ASSOCIATION

1 Copy  
Electronically Transmitted

SERVICE LIST  
(Docket No. 2011-0206)

DEAN T. YAMAMOTO, ESQ.  
YAMAMOTO & SETTLE  
700 Bishop Street, Suite 200  
Honolulu, HI 96813  
Counsel for CASTLE & COOKE HOMES HAWAII, INC.,  
CASTLE & COOKE RESORTS, LLC and  
LANAI SUSTAINABILITY RESEARCH, LLC

1 Copy  
Electronically Transmitted

MICHAEL J. HOPPER, ESQ.  
DEPUTY CORPORATION COUNSEL  
DEPARTMENT OF THE CORPORATION COUNSEL  
COUNTY OF MAUI  
200 S. High Street  
Wailuku, HI 96793  
Counsel for the COUNTY OF MAUI

1 Copy  
Electronically Transmitted

CURTIS SEYMOUR  
SENIOR MANAGER, GOVERNMENT AFFAIRS  
SUN EDISON LLC  
600 Clipper Drive  
Belmont, CA 94002

1 Copy  
Electronically Transmitted

MONA W. CLARK, ESQ.  
OFFICE OF THE COUNTY ATTORNEY  
COUNTY OF KAUAI  
4444 Rice Street, Suite 200  
Lihue, HI 96766-1300

1 Copy  
Electronically Transmitted

BRADLEY ALBERT  
PRESIDENT  
HAWAII PV COALITION  
P.O. Box 81501  
Haiku, HI 96708

1 Copy  
Electronically Transmitted

HILTON H. UNEMORI  
ECM, INC.  
130 N. Market Street  
Wailuku, HI 96793-1716  
For SOUTH MAUI RENEWABLE RESOURCES, LLC

1 Copy  
Electronically Transmitted

SKY STANFIELD  
KEYES, FOX & WIEDMAN LLP  
436 14th Street, Suite 1305  
Oakland, CA 94612  
For the INTERSTATE RENEWABLE ENERGY COUNCIL

1 Copy  
Electronically Transmitted

SERVICE LIST  
(Docket No. 2011-0206)

PETE COOPER  
SOLARCITY CORPORATION  
REGIONAL DIRECTOR, HAWAII  
599 Kahelu Street  
Mililani, HI 96789

1 Copy  
Electronically Transmitted

STANLEY ALLEN GRAY, SENIOR DEVELOPER  
Pier 1, Bay 3  
San Francisco, CA 94111  
For MOLOKAI RENEWABLES LLC

1 Copy  
Electronically Transmitted

ALISON SILVERSTEIN  
19213 Luedtke Lane  
Pflugerville, TX 78660

1 Copy  
Electronically Transmitted

BRENDAN KIRBY  
12011 SW Pineapple Court  
Palm City, FL 34990

1 Copy  
Electronically Transmitted

# Distributed Generation Interconnection Plan (DGIP)



Hawaiian Electric  
Maui Electric  
Hawai'i Electric Light



# Response to Hawaii Public Utilities Commission Order No. 32053

August 26, 2014



Hawaiian Electric Companies submit this Distributed Generation Interconnection Plan to comply with the Decision and Order issued by the Hawai'i Public Utilities Commission on April 28, 2014, in Docket No. 2011-0206, Order No 32053.

# Table of Contents

**ABSTRACT** .....XI

    Overall approach to Distributed Generation ..... xi

    Overview of DGIP initiatives..... xii

    Outcome of the DGIP..... xiii

**EXECUTIVE SUMMARY**..... ES-1

    Distributed Generation Circuit Penetration Levels..... ES-2

    Transitioning to a More Modern Grid ..... ES-3

    Distributed Generation Interconnection Capacity Analysis..... ES-5

    Distribution Circuit Improvement Implementation Plan— Base Case Cost Model .... ES-7

    Distribution Circuit Improvement Implementation Plan—Cost-Benefit Model ..... ES-14

    Advanced DER Technology Utilization Plan..... ES-17

    Non-Export Distributed Generation System..... ES-23

    Cost Allocation and Rate Reform ..... ES-26

**1. OVERVIEW OF DISTRIBUTED GENERATION** ..... 1-1

    1.1 Strategic approach to Distributed Generation..... 1-1

    1.2 Hawai'i Public Utilities Commission Order No. 32053..... 1-8

    1.3 Principles Governing Distributed Generation ..... 1-10

    1.4 Growth Rate and Penetration ..... 1-11

    1.5 Impacts of Distributed Generation..... 1-12

    1.6 System-Level Impacts ..... 1-13

**Table of Contents**

1.7 Substation/Circuit-Level Impacts ..... 1-14

1.8 Customer-Level Issues ..... 1-16

**2. DISTRIBUTED GENERATION INTERCONNECTION CAPACITY ANALYSIS (DGICA) ..... 2-1**

2.1 Technical Impacts ..... 2-2

2.2 Circuit Upgrade Requirements ..... 2-14

**3. DISTRIBUTED CIRCUIT IMPROVEMENT IMPLEMENTATION PLAN (DCIIP) ..... 3-1**

3.1 Proposed Mitigation Strategies and Action Plans ..... 3-1

3.2 Cost Allocation Implications ..... 3-21

**4. ADVANCED DER TECHNOLOGY UTILIZATION PLAN (ADERTUP) ..... 4-1**

4.1 Modern Grid ..... 4-3

4.2 Advanced Inverters ..... 4-19

4.3 Distributed Storage ..... 4-28

4.4 Integrated Demand Response Portfolio Plan ..... 4-38

4.5 Electric Vehicles (EV) and Electric Vehicle Supply Equipment (EVSE) ..... 4-49

4.6 Non-Export Distributed Generation ..... 4-56

4.7 Energy Excelsior Program and Other Pilot Programs ..... 4-56

4.8 Advanced Technology Costs ..... 4-66

4.9 Technology Assessment Roadmap ..... 4-68

**5. NON-EXPORT DISTRIBUTED GENERATION SYSTEM ..... 5-1**

5.1 Non-Export Overview ..... 5-1

5.2 Technical Aspects of Non-Export DG ..... 5-6

5.3 Rule 14H and Non-Export Implementation ..... 5-10

5.4 Grid Impacts and Benefits ..... 5-13

5.5 Non-Export Impact on Circuit Upgrades ..... 5-17

5.6 Non-Export Rate Structure ..... 5-18

5.7 Non-Export Technology Development ..... 5-19

6. COST ALLOCATION AND RATE REFORM ..... 6-1

    6.1 Overview ..... 6-1

    6.2 Cost Allocation ..... 6-2

    6.3 Rate Impacts of DG ..... 6-7

    6.4 DG 2.0 ..... 6-16

7. CONSUMER PROTECTION AND INTERCONNECTION ..... 7-1

8. ROADMAPS AND PLAN SUMMARIES ..... 8-1

    8.1 Planning Approach ..... 8-2

    8.2 Short-Term Plans ..... 8-3

    8.3 Advanced DER Utilization Plan ..... 8-6

    8.4 Non-Export Systems ..... 8-9

    8.5 Rates and Programs ..... 8-9

A. DGIP COMPLIANCE MATRIX ..... A-1

B. DG MARKET FORECAST METHODOLOGY ..... B-1

    Overview ..... B-1

    Key assumptions ..... B-1

    Calculations and output ..... B-4

C. GLOSSARY AND ACRONYMS ..... C-1

D. DGIP SUPPORTING DOCUMENTS ATTACHMENT LISTING ..... D-1

Table of Contents

This Page Intentionally Left Blank



# List of Figures

Figure ES-1. DG Growth for Oahu 2010-2014 ..... ES-2

Figure ES-2. DG Growth Projections ..... ES-3

Figure ES-3. The Comprehensive Distributed Generation Interconnection Plan ..... ES-4

Figure ES-4. Cumulative Estimated Costs of Recommended System Replacements ..... ES-11

Figure ES-5. Non-Export Cumulative Cost Options ..... ES-17

Figure ES-6. The Companies Modern Grid ..... ES-19

Figure ES-7. Phases of Advanced Inverter Feature Sets ..... ES-19

Figure ES-8. Advanced DER Technology Roadmap ..... ES-22

Figure ES-9. Summary of Estimated Increase in Lost Contributions to Fixed Costs ..... ES-28

Figure 1-1. Key Strategic Initiatives to Enable DG Growth ..... 1-6

Figure 1-2. Hawaiian Electric Companies DG Capacity, by Year ..... 1-9

Figure 1-3. DG Growth for Oahu, by Year ..... 1-11

Figure 1-4. DG Growth Projections ..... 1-12

Figure 3-1. Cumulative Estimated Costs of Recommended System Replacements ..... 3-8

Figure 3-2. Hawaiian Electric Cumulative Estimated Costs of Recommended System Replacements ..... 3-9

Figure 3-3. Maui Electric Cumulative Estimated Costs of Recommended System Replacements ..... 3-9

Figure 3-4. Hawai'i Electric Light Cumulative Estimated Costs of Recommended System Replacements ..... 3-10

Figure 3-5. Non-Export Cumulative Cost Options ..... 3-17

Figure 3-6. Integrating Queuing with Proactive Planning ..... 3-21

## Table of Contents

Figure 4-1. The Companies' Smart-Grid Applications .....	4-4
Figure 4-2. Advanced Metering Infrastructure (AMI) Example .....	4-5
Figure 4-3. Volt/VAR Optimization Impact on Tariff Specifications.....	4-6
Figure 4-4. Volt/VAR Optimization Example .....	4-6
Figure 4-5. Distribution Automation Example .....	4-8
Figure 4-6. Smart-Grid Implementation Overview .....	4-17
Figure 4-7. Advanced Inverter Feature Sets .....	4-22
Figure 4-8. Smart Inverter Feature Availability from SIWG.....	4-28
Figure 4-9. Configurations—Scenario 1: Residential DESS .....	4-30
Figure 4-10. DESS Near-Premises .....	4-32
Figure 4-11. Substation DESS.....	4-32
Figure 4-12. End-Use Identification Process.....	4-40
Figure 4-13. Integrated Demand Response Portfolio Roadmap.....	4-49
Figure 4-14. EV Roadmap.....	4-55
Figure 4-15. Advanced Technology Project Evaluation Process.....	4-59
Figure 4-16. Advanced DER Technology Roadmap .....	4-69
Figure 5-1. Non-Export DG (PV) System .....	5-8
Figure 5-2. PV System with Energy Storage Designed for Parallel Operation.....	5-11
Figure 5-3. Oahu Irradiance Variability Measured on 2-Second Time Scale (NREL).....	5-17
Figure 6-1. Percentage Penetration to Date .....	6-8
Figure 6-2. Hawaiian Electric Renewables Comparison of Price .....	6-9
Figure 6-3. Estimated Lost Contribution to Fixed Costs .....	6-12
Figure 6-4. Estimated Annualized Impact on Typical Residential Bill of 600 kWh/Month Based on NEM Installations as of Year End .....	6-13
Figure 8-1. The Comprehensive Distributed Generation Interconnection Plan .....	8-1
Figure 8-2. DG Growth Projections .....	8-2
Figure 8-3. Advanced Distributed Energy Technology Roadmap.....	8-8

# List of Tables

Table ES-1. DG Effects and Mitigation Activities ..... ES-7

Table ES-2. Violation Trigger and Base Case Cost Model Summarization, by Term ..... ES-9

Table ES-3. By Company Base Case Cost Model Summarization by Term ..... ES-11

Table ES-4. Circuit-Level Improvements ..... ES-12

Table ES-5. DG Effects and Their Corresponding Mitigations ..... ES-14

Table ES-6. Projected 2030 Cumulative Capital Cost Comparison DGIP versus Non-Export Options ..... ES-16

Table ES-7. Advanced Technology Programs and Costs ..... ES-23

Table ES-8. Technical and Economic Characteristics of a Non-Export DG System ..... ES-25

Table ES-9. Overview of Existing and Future DG Tariffs ..... ES-32

Table 2-1. Existing Penetration Levels on the Studied Circuits ..... 2-6

Table 2-2. Maximum Allowable Penetration Levels Identified ..... 2-8

Table 2-3. TSF-H158 and H159 TrOV Study Results ..... 2-10

Table 2-4. H111-2 TrOV Study Results ..... 2-11

Table 2-5. TSF-H132 TrOV Results ..... 2-11

Table 2-6. DG and Load Growth Projections ..... 2-14

Table 2-7. Existing Capacity Study Results—Substation Transformers ..... 2-15

Table 2-8. Projected Capacity Study Results—Substation Transformers ..... 2-17

Table 2-9. Existing Capacity Study Results—Circuits ..... 2-17

Table 2-10. Projected Capacity Study Results—Circuits ..... 2-18

Table 2-11. DG Effects and Mitigation Activities ..... 2-19

Table 3-1. LTC Controller Upgrades ..... 3-4



## Table of Contents

Table 3-2. Circuit Upgrade Program .....	3-5
Table 3-3. Substation Transformer Upgrades .....	3-6
Table 3-4. Grounding Transformer Upgrades .....	3-6
Table 3-5. Violation Trigger and Base Case Cost Model Summarization, by Term .....	3-7
Table 3-6. Cost Summarization, by Term .....	3-8
Table 3-7. Status of Budget DGIP and Company Budget Projects .....	3-11
Table 3-8. Circuit-Level Improvements .....	3-12
Table 3-9. List of Potential Mitigation Measures .....	3-14
Table 3-10. Projected 2030 Cumulative Capital Cost Comparison DGIP versus Non-Export Options .....	3-17
Table 3-11. Cumulative Cost Comparison DGIP Versus Non-Export Option .....	3-17
Table 4-1. Tiers of Communication Infrastructure.....	4-15
Table 4-2. Smart-Grid Applications and Communications Requirements .....	4-16
Table 4-3. Smart-Grid Capabilities for the Initial Phase and Full Implementation .....	4-18
Table 4-4. Storage Scenario .....	4-35
Table 4-5. Advanced Technology Development Program Summary .....	4-37
Table 4-6. DR Grid Service Requirements .....	4-39
Table 4-7. Attributes of Existing DR Programs .....	4-41
Table 4-8. Assessment of Existing Programs Relative to Grid Requirements .....	4-41
Table 4-9. IDRPP Planned Programs .....	4-44
Table 4-10. Oahu Programs With Projections .....	4-46
Table 4-11. Hawaii Programs with Projection .....	4-47
Table 4-12. Maui Programs with Projection .....	4-48
Table 4-13. Examples of SAE Standards Supporting EV/EVSE/Utility Activities.....	4-53
Table 4-14. Energy Exceclerator Engagements .....	4-58
Table 4-15. Advanced Technology Project Summary .....	4-66
Table 4-16. Advanced Technology Programs and Costs .....	4-67
Table 4-17. Advanced Technology Project Cost Breakdown.....	4-68
Table 5-1. Cumulative NEM and SIA Installed Capacity .....	5-3
Table 5-2. Technical and Economic Characteristics of a Non-Export DG System .....	5-5
Table 5-3. Non-Export Operational Concerns and Responses .....	5-6
Table 6-1 Total DGIP costs by island for each mitigation measure. ....	6-3
Table 6-2. Hawaiian Electric DGIP Costs by Island for Each Mitigation .....	6-5

Table 6-2a. Maui Electric DGIP Costs by Island for Each Mitigation..... 6-5

Table 6-2b. Hawaii Electric Light DGIP Costs by Island for Each Mitigation ..... 6-6

Table 6-3. Overview of Existing and Future DG Tariffs ..... 6-20

Table 8-1. Violation Trigger and Base Case Cost Model Summarization, by Term ..... 8-5

Table 8-2. Total Upgrade Costs by Company by Time Period ..... 8-5

Table 8-3. Advanced Technology Project Cost Breakdown..... 8-6

Table B-1: Hypothetical DG Residential fixed charge and feed-in-tariff assumptions  
under DG 2.0 ..... B-3

Table D-1. DGIP Supporting Documents Attachment Listing.....D-1

Table of Contents

This Page Intentionally Left Blank



# Abstract

---

## OVERALL APPROACH TO DISTRIBUTED GENERATION

The dramatic growth of distributed generation (DG) resources – particularly rooftop photovoltaic systems (PV) – has transformed Hawai‘i’s energy ecosystem over the past five years. The Hawaiian Electric Companies<sup>1</sup> (the Companies) envision a future in which the market demand for DG driving this growth remains high. The Companies are committed to meeting this demand under a model that appropriately balances the interests of all customers and stakeholders.

Four simple principles provide the foundation for this approach to distributed generation:

- Policies should lead to a sustainable set of customer options for DG
- The Companies must be proactive in responding to customer demand for DG
- All initiatives must ensure the safety and reliability of the grid for all customers
- Rates governing DG interconnections must fairly reflect the value of the power provided from and to the power grid, and must fairly allocate the fixed costs of the grid to all customers

Based on these principles, the Companies will address structural constraints on the growth of DG by offering a range of DG options, based on tariff structures that are fair and equitable for all customers, while maintaining the safety and reliability of the power network.

---

<sup>1</sup> Hawaiian Electric Company, Inc. (Hawaiian Electric), Maui Electric Company, Limited (Maui Electric), and Hawai‘i Electric Light Company, Inc. (Hawai‘i Electric Light)

---

## OVERVIEW OF DGIP INITIATIVES

This Distributed Generation Interconnection Plan (DGIP) outlines a set of operational improvements, regulatory reforms, and new DG-related products and services essential to enabling this vision for the future of DG.

### Proactively mitigate operational constraints

High levels of DG penetration can create technical challenges at the distribution level and reliability risks for the overall power system. To address these challenges, the DGIP outlines:

- Specific circuit and power system upgrades required to enable higher levels of DG penetration in a proactive manner
- Plans to implement advanced inverters and other technologies, including two-way communications and other elements of the modernized grid, to maintain a safe and reliable network in the presence of DG
- Plans to change inverter performance and specifications for both existing and future DG installations to address circuit and overall power system technical challenges.

In the short term, the Companies will increase the capacity of circuits to support DG, and they will enable interconnections as long as such connections do not jeopardize the grid's safety and reliability or impose unreasonable costs on customers. The Companies are working with inverter manufacturers to test and confirm inverter features that will enable an increase in gross daytime minimum load (GDML) limits from 120% to a target of 150%. When additional analysis is required, particularly on highly penetrated circuits, the Companies will provide a clear and transparent path forward for applicants.

In the medium and long term, the Companies will work to proactively address circuit- and system-level issues through circuit upgrades and the use of advanced inverter designs coupled with two-way communications, energy storage, and other technologies.

### Implement more equitable tariff structures

Regulatory and policy reform is essential to ensure that the incentives for future DG interconnections are aligned with the interests of all customers. To that end, the DGIP describes policies that better reflect the value of DG to the grid and the value of the grid to DG customers. In the short term, these policies entail transitioning the Net Energy Metering (NEM) program to a modified "Schedule Q" tariff and a non-export option.

In parallel, the Companies anticipate that the proceeding initiated by Order No. 32269 issued by the Commission on August 21, 2014 will establish a revised set of DG tariffs as

part of an approach to distributed generation called "DG 2.0." Under revised tariff structures, DG 2.0 will enable the interconnection of export and non-export systems in a manner that fairly allocates costs among all customers and appropriately compensates DG providers.

## Develop additional products and services for DG customers

In keeping with the Companies' commitment to enable DG growth in a fair and sustainable manner, the DGIP also introduces new products and services that expand customer options for DG. These offerings will include multiple ways of accessing DG resources—including export and non-export systems and community solar—to maximize the benefits of DG across all customers. Customers also will have the option of making positive contributions to the grid through the provision of ancillary and other services from customer-sited storage, electric vehicles, and other emerging technologies.

---

## OUTCOME OF THE DGIP

The initiatives outlined in the DGIP represent an approach to DG that balances the priorities of DG and full-service customers with the Companies' responsibilities and the wider benefits to stakeholders across Hawai'i. If implemented, these initiatives will nearly triple the amount of distributed photovoltaics installed across the Companies' service territory to over 900 MW, ensuring that DG remains a core component not just of the Companies' planning, but of Hawai'i's energy future as a whole.

This Page Intentionally Left Blank



# Executive Summary

The Hawaiian Electric Companies<sup>2</sup> (the Companies) lead the nation in the integration of residential and commercial solar photovoltaic (PV) systems. The Public Utilities Commission of the State of Hawaii (the Commission) recognized this leadership in Order No. 32053 (the Order).<sup>3</sup> Because it leads the United States in PV system penetration, the Companies stand at the forefront of the interconnection challenges associated with high penetration levels and will, by necessity, lead the way in solving the challenges associated with the high penetration of distributed generation (DG).

Pursuant to the Commission's directives in the Order, the Companies respectfully submit this Distributed Generation Interconnection Plan (DGIP) to address these challenges proactively, analyze potential constraints, and provide strategies and action plans to mitigate these constraints, including necessary circuit and system upgrades and process improvements. Implementing the DGIP's recommended actions will result in increased capacity to support DG, at both the circuit and system levels, and improve overall customer options related to DG. The recommendations are:

- Specific circuit and power system upgrades required to enable higher levels of DG integration in a proactive manner
- Plans to change inverter performance and specifications for both existing and future DG installations to address circuit and overall power system technical challenges
- Implementation of advanced inverters and other technologies, including two-way communications and other elements of the modernized grid, to maintain a safe and reliable network in the presence of DG

---

<sup>2</sup> Hawaiian Electric Company, Inc. (Hawaiian Electric), Maui Electric Company, Limited (Maui Electric), and Hawai'i Electric Light Company, Inc. (Hawai'i Electric Light)

<sup>3</sup> Order No. 32053, filed in Docket No. 2011-0206, on April 28, 2014



**Executive Summary**  
Distributed Generation Circuit Penetration Levels

- Proposals for rate alternatives ("DG 2.0") to ensure that the incentives for future DG interconnections are aligned with the interests of all customers
- Proposals for new product and service offerings to increase customer options for participating in DG programs

Building on these recommendations, the Companies will execute a strategy that balances priorities for DG and full service customers with the utility's responsibilities and the wider benefits to stakeholders across Hawai'i. In so doing, the Companies will ensure that DG remains a core component not just of the utility's planning, but of the shared vision for Hawai'i's energy future as a whole.

---

## DISTRIBUTED GENERATION CIRCUIT PENETRATION LEVELS

The growth rate of DG has been exceptionally high in Hawai'i. **Figure ES-1** illustrates the net system load impact of DG's growth during the past four years for Oahu. In June 2010, transmission-connected generation provided more than 1,100 megawatts (MW) of daytime peak generation. During the same time period in 2014, the generation that was not DG provided less than 900 MW. The reduction of more than 200 MW of load during the day's peak solar intensity is due to the growth of DG reducing demand served by utility-scale generation.

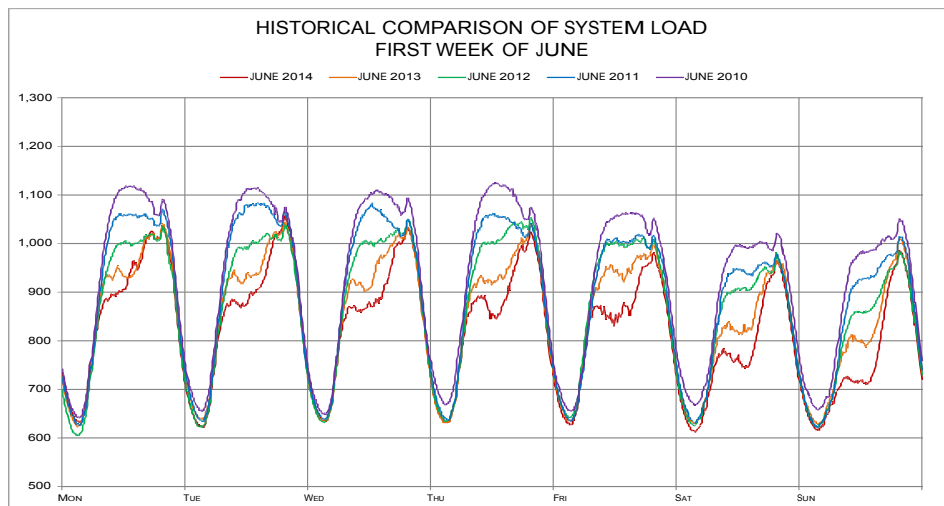

Figure ES-1. DG Growth for Oahu 2010-2014

As the Commission has recognized, no other utility in the nation has attained the over 18% daytime DG integration that Hawai'i has.<sup>4</sup> This achievement is compounded by the unique issues associated with operating power grids on islands because of the small size

---

<sup>4</sup> Order at 32.

of the systems, causing the system reliability to be very sensitive to imbalances of supply and demand. The reserve capacity for dealing with changes in demand is limited to the resources on the islands – the systems cannot rely on neighboring systems as is done on the U.S. mainland. With development of the DGIP, the Companies propose to take significant steps toward increasing DG growth on the islands in a proactive, fair, reliable, and sustainable way. **Figure ES-2** is the Companies’ DG market forecast, which shows the approximately tripling of DG by 2030 – this forecast is the basis for the changes proposed in this plan.

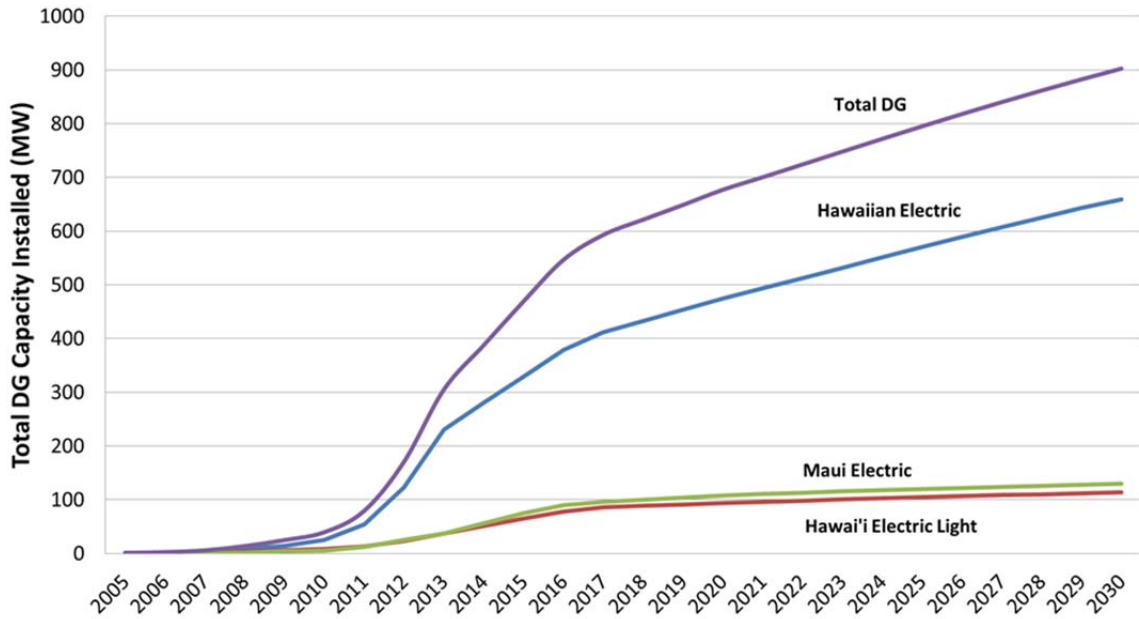

Figure ES-2. DG Growth Projections

## TRANSITIONING TO A MORE MODERN GRID

As the Commission observed in its Order, the high growth rate of DG in the 2010–2013 time period cannot realistically be sustained without changes in policy, technology, and the Companies’ business and operating models. Utility electric energy usage is declining, DG penetration at the distribution circuit levels are increasing, system-level reliability challenges are emerging, and the fixed costs for the grid increasingly are being shifted to full service customers.<sup>5</sup> Current programs that encourage this pace and volume of growth are no longer sustainable, and, accordingly, new programs that better reflect the true value provided by DG and the value of grid to DG customers must be considered.

<sup>5</sup> Order at 49.

**Executive Summary**  
 Transitioning to a More Modern Grid

To address these issues, the plan recognizes the importance of modernizing the grid. This program will:

- Incorporate circuit improvements that can safely and reliably accommodate more DG
- Change inverter performance for both existing and future DG systems to address circuit and overall power system technical challenges
- Modernize the grid by installing advanced metering and control systems that use data to drive decisions and investment, and
- Use rate structures and programs that balance customers’ needs equitably and send appropriate price signals

This will result in increased options for customers, and will lead to greater opportunities for all customers to participate in solar programs. **Figure ES-3** summarizes this solution.

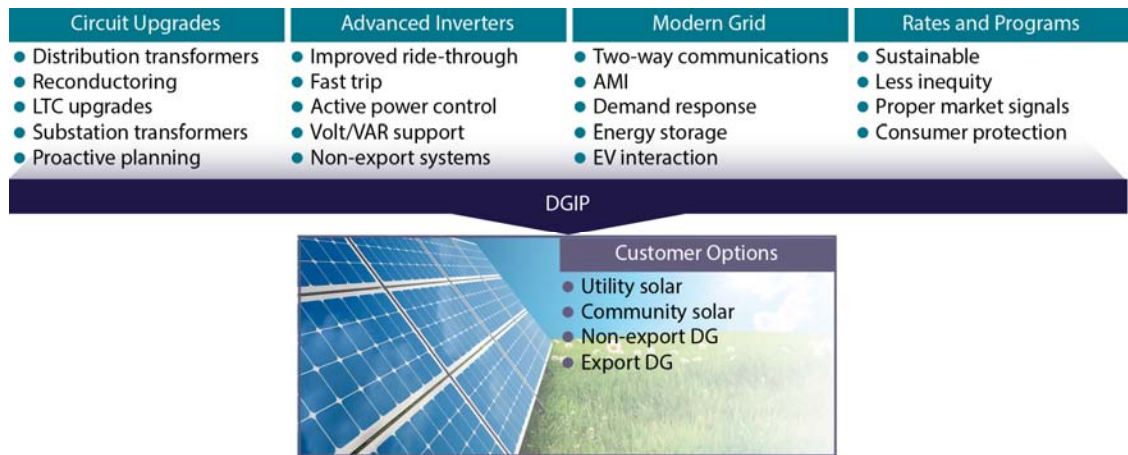

**Figure ES-3. The Comprehensive Distributed Generation Interconnection Plan**

In evaluating technological requirements needed to increase the amount of DG that can be supported, the current Net Energy Metering (NEM) program and rate structure, which increasingly adversely impacts non-NEM customers, has become unsustainable. Some fixed costs associated with supporting the grid are shifted to full service customers, with many NEM customers paying less than their cost for services they receive from the utility. This creates inequities between NEM and non-NEM customers. In addition, they supersede the integration of other renewable procurement programs that cost less and benefit all customers – both for NEM and non-NEM customers. The Companies propose transitioning the NEM program to a more equitable and sustainable rate mechanism under "DG 2.0." Fixed charges and interconnection fees are proposed to make the interconnection process more equitable and transparent and to better allocate DG-related costs to DG customers.

In the following discussions, more detail is provided on the Companies' plans to improve circuits, utilize advanced technologies, and align DG rates and programs in such a way as to allow for the significant increase in DG utilization that is foreseen.

---

## DISTRIBUTED GENERATION INTERCONNECTION CAPACITY ANALYSIS

Consistent with the Order, the DGIP includes a Distributed Generation Interconnection Capacity Analysis (DGICA) that adopts a process for proactively identifying distribution system upgrades needed to safely and reliably interconnect DG resources and increase circuit interconnection capability in capacity increments. The DGICA considers:

- Technical impacts and challenges associated with the export of energy from DG beyond the distribution circuit
- Development of recommended circuit modifications and upgrade requirements, including associated costs and customer impacts
- Identification of circuit penetration thresholds that represent a sound and technically based progression to increase circuit penetration as ongoing technical solutions are tested and experience is gained
- System-level reliability impacts from the aggregate amount of DG energy and how they relate to potential limits on the interconnection of DG<sup>6</sup>

Baseline system-level studies have been conducted to determine system level impacts of aggregate DG. Representative circuit penetration studies were performed to determine circuit penetration limits of the Companies' distribution systems. The Hawaii Grid Cluster Evaluation has also been performed in response to the Commission Order to determine the system and circuit penetration limits within the Companies' distribution systems.

These studies indicate that the constraining factors for DG under existing technical and operational interconnection requirements are system reliability impacts that arise before most circuit limits are reached. The system reliability constraints are existing issues that must be addressed for the current levels of DG interconnection. Because DG supplants conventional generation without providing equivalent system benefits, overall system reliability may be compromised.

Issues on the generation and transmission system, such as system reliability and the need for flexible resources for regulation and ramping are evaluated in system studies addressed in the Power Supply Improvement Plans (PSIP). The PSIP analysis

---

<sup>6</sup> Order at 51–52.

incorporates mitigation measures already identified and in the Companies' near-term plans, including protective relay upgrades and a dynamic under-frequency load-shedding for substations, as well as the requirement to expand supervisory control and data acquisition (SCADA) to substations.

At a distribution circuit level, the Companies' Representative Circuit Penetration Studies indicate that the ability of a circuit to integrate DG is primarily a function of a Transient Over Voltage (TrOV) threshold and the ability of a circuit to accommodate the load from an adjacent circuit due to switching actions or contingency situations. The determinants of the amount of DG a distribution circuit can accept are the extent to which issues on the circuits arise and can be resolved and the extent to which the aggregate amount of DG on distribution circuits causes system-level issues and can be resolved.

For the TrOV issue, the current limit is 120% gross daytime minimum load (GDML) and the Companies are working with the inverter manufacturers to test and confirm inverter features that enable a higher GDML limit targeted at 150% GDML. To move to and beyond these near-term levels, the Companies are implementing the recently filed Distribution Circuit Monitoring Plan and working with the local PV industry, inverter manufacturers, the National Renewable Energy Laboratory (NREL) and the Electric Power Research Institute (EPRI) on testing and standards for advanced inverter functions that could mitigate the TrOV and system level concerns to allow additional DG on these circuits.

A project with NREL and Solar City in 2014–2015 will utilize NREL's Energy Systems Integration Facility capability to test advanced inverter functionality and analyze DG and distribution equipment as it is being used. Tasks that will be completed include testing of: (1) DG inverter TrOV, (2) anti-islanding of multiple inverters, (3) advanced inverter volt/VAR support, and (4) bidirectional power flow. The DGICA assumes that advanced inverter functions, field data from circuit monitoring, and/or other mitigations such as shorting switches or surge arresters will enable DG integration to surpass existing TrOV limits and identifies the next level of constraints to analyze the potential impact of the Companies' market forecast for DG integration.

The next level of circuit level constraints includes the thermal limits of backfeed or reverse current flow caused by DG. The concern is whether electrical system components and controls can operate properly under backfeed conditions. In general, electric systems are designed with more capacity near the source and less capacity as loads are dispersed off the lines. When new generation sources are added in the weaker areas of the system, equipment loading and voltage rise become issues.

DG effects on the subtransmission, substation, circuit and local levels and the potential identified mitigations to address them are listed in **Table ES-1**.

Effect from DG	Mitigation Activity
Reverse flow through the substation transformer causing voltage regulation problems	Upgrade Load Tap Changer (LTC) controls if needed
Reverse flow through a circuit with voltage regulators causing voltage regulation problems	Upgrade voltage regulator controls
DG greater than 50% capacity of backbone circuit rating risking line overloading and equipment failure during load transfers and resulting in power quality problems	Upgrade line equipment capacity
DG greater than 50% capacity of substation transformer risking transformer overloading and equipment failure during load transfers	Upgrade substation transformer and switchgear capacity
DG greater than 33% GDML for applicable circuit configurations risking power quality problems during circuit events	Add grounding transformer on circuit (For pre-determined circuits if needed)
DG greater than 50% GDML for 46-kV sub-transmission lines risking power quality problems during circuit events	Add grounding transformer on 46-kV line
Distribution transformer capacity exceeded and/or localized high voltage on the secondary resulting in possible power quality problems or equipment failures	Upgrade distribution transformer capacity; new pole, and secondary also may be needed

Table ES-1. DG Effects and Mitigation Activities

## DISTRIBUTION CIRCUIT IMPROVEMENT IMPLEMENTATION PLAN— BASE CASE COST MODEL

The DGIP includes a Distribution Circuit Improvement Implementation Plan (DCIIP) that summarizes specific strategies and actions, including associated costs and schedules, for circuit upgrades and other mitigation measures. These measures will increase grid capacity and enable the interconnection of additional DG.<sup>7</sup> The DGIP prioritizes the proposed mitigation actions as follows:<sup>8</sup>

- Focus on the immediate constraints for interconnection of additional DG
- Analyze the costs and benefits of proposed mitigation strategies and action plans
- Discuss how distribution system design and operational practices could be modified for interconnection of additional DG

<sup>7</sup> Order at 54-55.

<sup>8</sup> Order at 55.

## Executive Summary

### Distribution Circuit Improvement Implementation Plan— Base Case Cost Model

- Address proposals for cost allocation issues that determine who bears responsibility for system upgrade costs.

Load and DG projections are based on preliminary, market-driven forecasts for DG uptake across Oah‘u, Maui County, and Hawai‘i. These forecasts include NEM, feed-in tariff (FIT), and Standard Interconnection Agreement (SIA) projects through 2016, and assume an alternative tariff structure ("DG 2.0") beginning in 2017.

In evaluating each company’s projected load and DG, a base-case cost model was developed for distribution-level improvements for the short-term (2014-2016), mid-term (2017-2020), and long-term (2021-2030). The circuit and substation capacity analysis and base case cost model compare existing and projected loads with DG penetration and identify constraints on circuits and substation transformers.

The base-case cost model assumptions and schedule of component replacements to alleviate constraints based on the Companies’ DG market forecast for all islands is summarized in **Table ES-2**. Unit costs are high-level estimates based on typical design configurations for each company. Each company will have the discretion to require customer upgrades or upgrade utility infrastructure.

**Executive Summary**  
Distribution Circuit Improvement Implementation Plan—  
Base Case Cost Model

Item	Violation Trigger	Unit Cost	2016	2020	2030	Total
Installed DG (MW, all three Companies)	--	--	547	677	902	
Regulator	Feeder Reverse Flow	\$10,000	\$187,000	\$55,000	\$66,000	\$308,000
LTC	Substation Transformer Reverse Flow	\$10,000	\$912,000	\$264,000	\$466,000	\$1,642,000
Reconductoring	Exceed 50% Backbone Conductor/Cable Capacity	\$1,100,000 OH/ \$4,300,000 UG per mile	\$-	\$-	\$75,588,700	\$75,588,700
Substation Transformer and Switchgear	Exceed 50% Capacity	Varies	\$2,541,000	\$2,475,000	\$49,750,000	\$54,766,000
Distribution Transformer	Exceed 100% Loading, % GDML Linear Relationship to % Transformers Upgraded	Varies	\$4,462,164	\$4,386,633	\$6,768,738	\$15,617,535
Poles and Secondary	Assumed 15% of Distribution Transformer Replacements Include Pole Replacement and Secondary Upgrades	Varies	\$1,016,605	\$993,371	\$1,523,365	\$3,533,342
Grounding Transformers	Exceed 33% GDML (66% in model) for Selected Feeder for Maui Electric and Hawai'i Electric Light; exceed 50% GDML for 46 kV Lines for Hawaiian Electric	\$60,000 for Maui Electric Company and Hawai'i Electric Light; \$947,000 for Hawaiian Electric	\$33,033,000	\$6,095,100	\$3,917,100	\$43,045,200
<b>Total</b>	--	--	<b>\$42,151,769</b>	<b>\$14,269,104</b>	<b>\$138,079,904</b>	<b>\$194,500,777</b>

Table ES-2. Violation Trigger and Base Case Cost Model Summarization, by Term



This Page Intentionally Left Blank



**Table ES-3** summarizes the estimated costs of recommended circuit improvements for each of the Companies.

Location	Cost 2014-2016	Cost 2017-2020	Cost 2021-2030
Hawaiian Electric	\$35,454k	\$10,377k	\$136,589k
Maui Electric Total	\$2,608k	\$2,539k	\$1,227k
Maui	\$2,550k	\$2,261k	\$1,219k
Molokai	\$58k	\$279k	\$8k
Lanai	\$0	\$0	\$0
Hawai'i Electric Light	\$4,090k	\$1,352k	\$264k
<b>Total</b>	<b>\$42,152k</b>	<b>\$14,269k</b>	<b>\$138,080k</b>

\*calculations based in current year dollars

Table ES-3. By Company Base Case Cost Model Summarization by Term

**Figure ES-4** summarizes the cumulative estimated costs of recommended system replacements and projected installed DG in the short-, medium-, and long-term.

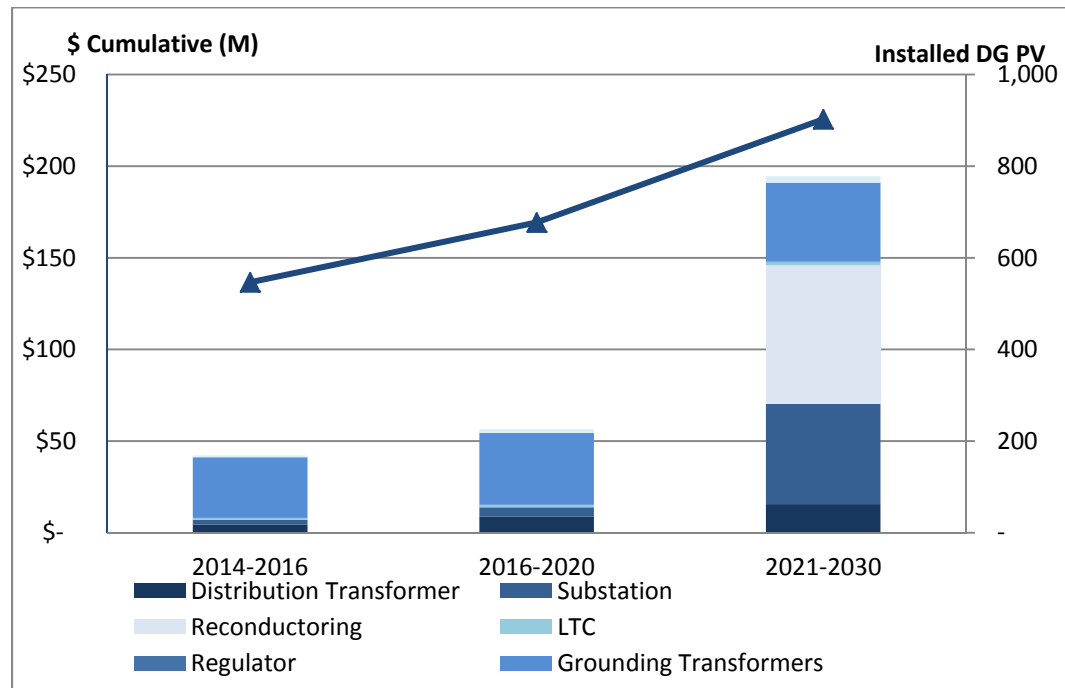

\*in current year dollars

Figure ES-4. Cumulative Estimated Costs of Recommended System Replacements

## Prioritization of Proposed Mitigation Actions

The figures in **Table ES-3** are high-level base-case cost estimates for potential capacity upgrades that may be required based on the market potential for DG. The prioritized list of expected mitigations for circuit-level improvements is shown in **Table ES-4**.

Improvements	Hawaiian Electric			Maui Electric			Hawai'i Electric Light		
	2016	2020	2030	2016	2020	2030	2016	2020	2030
LTC Controller Upgrades (#)	32	14	24	19	3	9	22	7	5
Voltage Regulator Controller Upgrades (#)	7	2	1	4	1	1	6	2	4
Primary Conductor Upgrades (Backbone and Laterals) (miles)	0	0	16.6	0	0	0	0	0	0
Substation Transformer Upgrades (#)	0	1	20	1	0	1	1	0	0
Distribution Transformer Upgrades (#)	280	341	601	49	19	12	153	77	5
Grounding Transformers (#)	30	3	3	23	34	10	4	10	2

Table ES-4. Circuit-Level Improvements

Simulation-based analysis with new models and validation, using field-measured information consistent with a proactive approach, will be used to evaluate the most cost-effective measures, determine which upgrades to deploy, and determine under what conditions – steady-state or transient – responses should be implemented. The current circuit analysis lays the framework for studying mitigation measures. Before the maximum thresholds for DG penetrations are reached, these studies also can be used to assess expansion needs and evaluate broader mitigation measures as the grid evolves and changes. New technologies that are appropriately modeled can then be simulated for their effectiveness without sacrificing reliability and performance of the current system.

The types and magnitude of mitigation measures depend on the circuit configuration, customer mix, and DG penetration, as shown by the plan analysis. These potential alternate mitigation actions include:

- Modify existing inverter controls for extended ride-through, fast-trip functionality, and, potentially, power factor control
- Specify non-export
- Add customer-level grounding banks
- Require direct transfer trip (DTT)
- Upgrade protection and voltage control equipment
- Upgrade customer transformer and secondary conductor
- Install line capacitors or line regulators to level the distribution voltage across the distribution circuit and the secondary service drops; adjust load tap changer (LTC)

settings to maintain a uniform voltage across the circuit by reducing the variability of voltage

- Support deployment of customer-side energy storage technologies and a non-export class of systems to reduce the impact of fluctuations in generation from solar variability, assist with voltage regulation, and avoid equipment overloads through various schemes, including a spread of PV energy across more hours in the day
- Transition to smarter and more advanced inverters, including two-way communications, utility active power control, configuration verification, and reactive power options, at a minimum, to provide the utility with increased reliability, security controls, and options
- Implement substation, grid, and/or other forms of battery storage when economically viable to provide additional generation when needed and to control voltage issues and equipment overloads
- Implement demand response options that turn on or off residential or commercial equipment during critical periods to control load, instead of solar variability, which is easier to implement; take advantage of smart-grid communications; and implement more advanced forms of demand response, including real-time balancing of load and DG
- Undertake voltage conversion projects to address transformer and circuit overloads and voltage issues

**Table ES-5** shows a partial list of potential mitigation measures that could be implemented under steady-state and first-contingency conditions. This list will likely be expanded to capture other potential mitigation measures as similar transient and dynamic studies are performed. The column headings in **Table ES-5** (System, Substation and Circuit, and Customer) are fully defined in Section 1 of this plan. The rows in bold type present a major mitigation measure. An expanded version of this information can be found in Attachment H.

**Executive Summary**  
 Distribution Circuit Improvement Implementation Plan—Cost-Benefit Model

Mitigation Measure	Applicable DG Effect						
	System		Substation and Circuit			Customer	
	<i>Transient</i>	<i>Steady State</i>	<i>Transient</i>	<i>Steady State</i>		<i>Transient</i>	<i>Steady State</i>
	<i>System Reliability</i>	<i>Excess Energy</i>	<i>TrOV</i>	<i>Voltage Issues</i>	<i>Equipment Overload</i>	<i>TrOV</i>	<i>Equipment Overload</i>
Change Existing Inverters (Ride through and trip settings)	S			S		S	
Advanced Inverter Functionalities	M		S			S / M	S / M
Active Power Control/Curtailment	M	M / L	S / M	M	M / L	S / M	S / M
Energy Storage - Utility side	M	M		M	M		
Energy Storage - Customer side		S		S	S	S	S
Non-Export (Size Limits)						S	S
Grounding Bank			S				
Circuit Direct Transfer Trip			S				
Customer Direct Transfer Switch			S			S	
Dynamic Load-Shed Scheme	S						
Substation Short Switch			M			M	
Customer Surge Arresters			S			M	
Voltage Control				S			
Equipment Upgrades (Primary and secondary conductor upgrades; primary voltage upgrade to 12kV)						S	S
Demand Response (Turning Off/On Equipment)		M		M	M		

S=2014–2016    M=2017–2020    L=2021–2030

Table ES-5. DG Effects and Their Corresponding Mitigations

## DISTRIBUTION CIRCUIT IMPROVEMENT IMPLEMENTATION PLAN—COST-BENEFIT MODEL

The base case cost model developed for the DCIIP assumes investment, as needed, to accommodate market-driven DG, with no external limits on DG growth or on circuit capacity. This approach does not include a cost-benefit analysis of the proposed mitigation measures. Several mitigation measures identified in **Table ES-5** may be more cost-effective than circuit or substation improvements identified in the base case cost model.

Consequently, the Companies developed an alternative cost model that would enable high levels of DG growth, while also assuming the Companies have some ability to shape and control the nature and distribution of this new DG. This approach identifies cost levers for applying particular technologies and establishes an estimated range of investment.

For instance, distribution transformer upgrades and/or steady state over-voltage may be mitigated by limiting PV system size to historical load or utilizing inverter volt-watt functions or fixed power factor adjustment. The Companies will evaluate these options to determine if they are viable alternatives to equipment upgrades. Implementing these smart inverter functions or a system size limit policy could potentially negate the estimated \$19.5 million cost of distribution transformer upgrades.

Circuit-level issues requiring grounding transformers and TrOV circuit limits may be mitigated with fast trip inverters, DTT, short switches, or surge arresters. Circuit-level storage can address capacity issues. These potential solutions will require additional research and development, but may prove to be viable options to the base case cost model.

A cost-effective means for reducing circuit improvement costs is to limit the DG capacity. To allow a greater number of customers to install DG on circuits with limited capacity, measures could be adopted that reduce the contribution of each system, such as limits on the DG installed, limiting the size of DG systems and/or requiring the use of non-export systems. The cost-benefit approach balances investment costs against the benefits and expense of installing significantly larger amounts of export DG. Therefore, it would improve circuits where those investments may lead to a large increase in DG penetration, but it would constrain expenditures on circuits where large investments might lead only to incremental increases in DG. This approach would be evaluated through a comprehensive and transparent process involving impacted stakeholders, the Department of Commerce and Consumer Affairs, Division of Consumer Advocacy (Consumer Advocate), and the Commission.

The base case cost model was developed by analyzing projected load and DG penetration to determine potential upgrades based on reasonable planning assumptions of circuit limitations and requirements. As grid modernization continues along with an advanced metering infrastructure (AMI), significantly more data can be collected on circuit performance. Advanced analytics services may enable circuits to perform more closely to their design limits, which would allow for more growth with less investment. Combining improved data collection with advanced inverter features also creates additional capabilities, including reactive power compensation (i.e., better voltage control).

The advanced controls of a modern grid may help manage DG energy, and allow demand response and customer load incentive programs such as time-of-use rates and

## Executive Summary

### Distribution Circuit Improvement Implementation Plan—Cost-Benefit Model

preferential Electric Vehicle (EV) charging programs. A modern system that can control load and generation (“up/down” control) may make it possible to defer, or avoid altogether, some circuit improvements. When combined with circuit monitoring and better data, the costs of improvements over the long term may be lower than predicted by a base case cost model.

At the circuit level, non-export DG does not contribute as heavily to reverse power flows and, therefore, could reduce the need for associated upgrades when compared to unmitigated exporting PV. This could allow more customers to install DG systems on circuits with a finite capacity for additional DG systems while deferring costs for circuit upgrades. However, non-export customers will reduce demand, which will result in exacerbating impacts of existing exporting DG; this ultimately may require some level of system modifications. Compared with the DGIP base case cost model, four levels of non-export were analyzed – 100%, 75%, 50%, and 25% of the proposed residential DG (NEM and DG 2.0) beginning in 2014. **Table ES-6** compares projected 2030 capital costs for each type of upgrade at these non-export levels. The table shows significant reduction in reconductoring, substation upgrades, and distribution transformer upgrades. **Figure ES-5** compares the cumulative costs for the short-, medium-, and long-term.

<i>Item</i>	<i>Base-Case Full Export</i>	<i>Non-Export 25%</i>	<i>Non-Export 50%</i>	<i>Non-Export 75%</i>	<i>Non-Export 100%</i>
Non-Exported DG (MW)	0	73	146	219	292
Regulator	\$308,000	\$297,000	\$242,000	\$220,000	\$198,000
LTC	\$1,642,000	\$1,546,000	\$1,447,000	\$1,304,000	\$1,172,000
Reconductoring	\$75,588,700	\$75,588,700	\$58,549,150	\$21,899,900	\$-
Substation	\$54,766,000	\$37,375,000	\$24,750,000	\$17,325,000	\$4,950,000
Distribution Transformers Including Pole and Secondary Replacements	\$19,150,877	\$16,142,757	\$13,274,162	\$10,578,792	\$9,674,502
Grounding Transformers	\$43,045,200	\$45,972,300	\$42,517,200	\$41,857,200	\$41,527,200
<b>TOTAL</b>	<b>\$194,500,777</b>	<b>\$176,921,757</b>	<b>\$140,779,512</b>	<b>\$93,184,892</b>	<b>\$57,521,702</b>

\*in current year dollars

Table ES-6. Projected 2030 Cumulative Capital Cost Comparison DGIP versus Non-Export Options

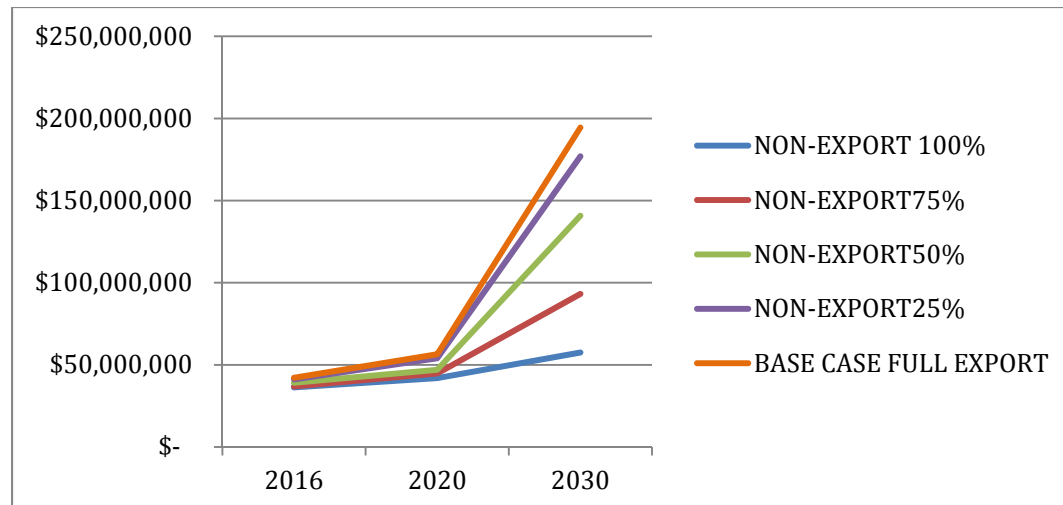

\*in current year dollars

Figure ES-5. Non-Export Cumulative Cost Options

## Modification of Distribution System Design Criteria and Operational Practices

In addition to specific improvement mitigations and upgrades, the Companies have modified distribution system planning and design criteria to harden the distribution system. Changes in distribution system design considerations for new and existing circuits include:

- Lowering impedance
- Optimizing reverse flow on voltage regulation equipment
- Mitigating circuit-level transient over-voltage

The Companies have also developed operations practices to accommodate higher penetrations of DG. Modifications to operating practices include:

- Operating within voltage regulation bands
- Maintaining distribution circuit flexibility
- Lengthening reclosing time of feeder breakers and reclosers for islanding protection
- Monitoring voltage regulator tap operations
- Implementing SCADA at distribution substations

---

## ADVANCED DER TECHNOLOGY UTILIZATION PLAN

Pursuant to the Commission's directives in the Order, the DGIP includes an Advanced Distributed Energy Resource Technology Utilization Plan (ADERTUP) that evaluates



technologies that may increase the amount of DG that can be placed into service.<sup>9</sup> Specifically, the Companies plan to use advanced inverters, energy storage, demand response and electric vehicles to mitigate the effects of DG where their use is cost effective, compared with competing technologies. In addition to these technologies, modern grid solutions, such as AMI and two-way communications, coupled with advanced data analytics and enhanced modeling tools, will be used to enable new DG management capabilities.

The Hawai'i legislature identified the need for grid modernization, as discussed in the ADERTUP. The legislature, in turn, directed the Commission to consider grid modernization in its planning and the potential of these technologies to mitigate technical barriers of DG:

*The legislature further finds that utility planning and construction of upgrades to the electrical system, including the use of advanced grid modernization technology such as energy storage, to accommodate anticipated growth in customer generation could resolve technical barriers in advance of the interconnection procedures being applied. Such proactive planning could ensure that all Hawaii residents are able to interconnect to the system in a timely manner.<sup>10</sup>*

Modernizing the grid will be required to fully enable DG growth. While the PSIPs have incorporated costs for implementing grid modernization, this topic goes far beyond what is described within the PSIPs. For this reason, all grid modernization topics within this document will reference Grid Modernization when referring to the implementation of this initiative.

A review of the anticipated modern grid model shows the objective is to integrate distributed resources into the overall grid management and control. This requires a combination of advanced capabilities from the utility and participation in grid management capabilities from distributed resources. The ADERTUP concludes that significant value exists in using capabilities of inverters in the short term. Requiring capabilities from inverters to be available will enable leveraging the full capabilities of advanced inverters once communications to the inverters are established. Implementing two-way communications, energy storage, demand response and EV integration will require grid modernization as depicted in **Figure ES-6**. Full deployment of these solutions will take several years to complete.

---

<sup>9</sup> Order at 52-53.

<sup>10</sup> Hawaii House Bill 1943, signed into law June 20, 2014.

Benefits	Applications		Description
Lower Electricity Bills	Volt / VAR Optimization		Allows utilities to more accurately control the level of power delivered to the end-consumer.
Expanded Customer Choices	Customer Energy Portal		Allows customers to monitor their bills and usage patterns to reduce energy consumption.
	Prepay		Provides customers the flexibility to pay as they use electricity to avoid deposits and help budget spend.
Increased Reliability	Advanced Metering Infrastructure		Enables automated billing for customers, reducing meter reading costs, as well as acts as a sensor for outage detection and many other applications.
	Outage Management		Enables automated billing for customers, reducing meter reading costs, as well as acts as a sensor for outage detection and many other applications.
	Fault Circuit Indicator		Helps utilities find outages on the grid to restore power to customers more quickly.
Optimal Integration of Distributed Generation	Remote Switching		Enables devices in the field to be remotely controlled to get an outage fixed more quickly.
	Direct Load Control		Shapes energy demand to ensure the grid can safely manage variable energy sources such as renewable wind or solar.
Reduced CO <sub>2</sub> Emissions	Electric Vehicle Charging		Enables the scheduling of electric vehicle charging.

Powered by Silver Spring Networks Smart Energy Platform (Secure Communications Network)

Figure ES-6. The Companies Modern Grid

The DGIP findings with regard to advanced inverters were influenced by research provided by EPRI and the Smart Inverter Work Group (SIWG) of the California Public Utilities Commission. The SIWG work identifies future inverter capabilities that will be requested of the inverter industry. The future capabilities are broken into three phases, as shown in Figure ES-7.

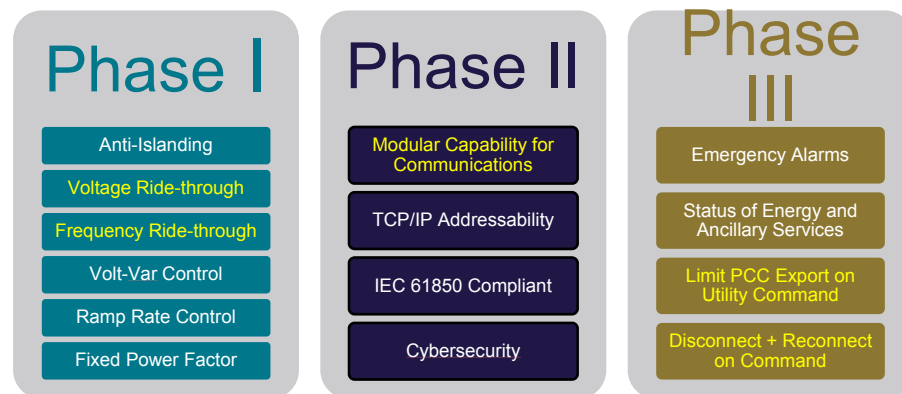

Note: Yellow indicates the most urgent need for the companies.

Figure ES-7. Phases of Advanced Inverter Feature Sets<sup>11</sup>

<sup>11</sup> “Recommendations for Updating the Technical Requirements for Inverters in Distributed Energy Resources,” Smart Inverter Working Group of the California Public Utilities Commission, Jan. 2014.

According to SIWG, commercial availability of Phase 1 capabilities is expected by the end of 2015, Phase 2 functions in the beginning of 2016, and Phase 3 functions by the end of 2016.

A primary circuit-level issue facing the Companies today is the potential for TrOV events when the opening of a substation breaker or another sectionalizing device coincides with reverse power flow through the breaker. Providing a fast-trip for high voltage conditions in the installed DG inverters will mitigate this issue. Currently, the Companies are working with inverter manufacturers to install equipment with consistent specifications for faster tripping.

The Companies are engaged in technical discussions with PV inverter manufacturers to explore the expansion of advanced inverter features that enable the approval of distributed PV projects above the 120% circuit penetration threshold. The Companies envision features that may include expanded ride-through features, improved trip settings, and active power control, and these features will increase the threshold for which inverters are authorized to interconnect to congested circuits. The Companies will continue to work with industry standards bodies and the manufacturers to advance the design of the inverters to allow for even greater penetration capabilities.

Another issue is frequency ride-through thresholds. In the past, the Companies used the IEEE-1547a-2014 standard as the threshold for under-frequency trip setting. Typically, most inverters were set to trip off at 59.3 Hz. Consequently, a significant amount of load and generation dropped offline when the frequency drops below 59.3 Hz. In response to this system stability issue, the Companies sought and were granted approval to modify Rule 14H, requiring inverters to ride through a frequency dip to 57 Hz. Further discussions between the Companies and external parties to determine how inverter-based distributed generation can provide additional system stability support resulted in the Companies recently submitting a request to again modify Rule 14H to require inverters to trip below 57 Hz and above 63 Hz. Expanding the threshold will improve grid stability by allowing variable PV resources to remain connected longer during frequency events.<sup>12</sup>

The Companies also are experiencing excess capacity from DG assets that are backfeeding onto the grid. Therefore, the Companies recommend that they have the capability to control DG output on a system-wide and/or circuit basis during emergency or contingency situations. Leveraging investment of the smart grid two-way communication system for DG inverter monitoring and control is one potential and

---

<sup>12</sup> Docket 2011-0206, Second Stipulation Regarding Work Products Submitted As a Part of the January 18, 2013 Final Report of the PV Sub-Group for the Reliability Standards Working Group, Filed June 12, 2014. Please see Revised Sheets No. 34B-16 and 34B-17.

attractive way to achieve this functionality. Until such a capability is in place, the Companies will need to carefully manage the amount of new DG being installed.

Consistent with the Order, the DGIP looks at two-way communications, energy storage, demand response, and EVs, and lays out a timeline for solutions to promote integration of DG onto the grid. The mid- and long-term key for integrating higher levels of DG while maintaining system reliability is increased control of power by the utility. As grid modernization is implemented, the overall system will become more dynamic. Two-way communications and the new AMI program will enable more visibility and control capability for interaction with distribution-sited energy storage, demand response through direct load control and two-way interaction with EVs.

The plan for implementing the ADERTUP is broken into three timeframes: short, medium and long term. A summary of the overall report, along with a roadmap for implementation, is provided in Section 8 and is shown in **Figure ES-8**.

**Executive Summary**  
Advanced DER Technology Utilization Plan

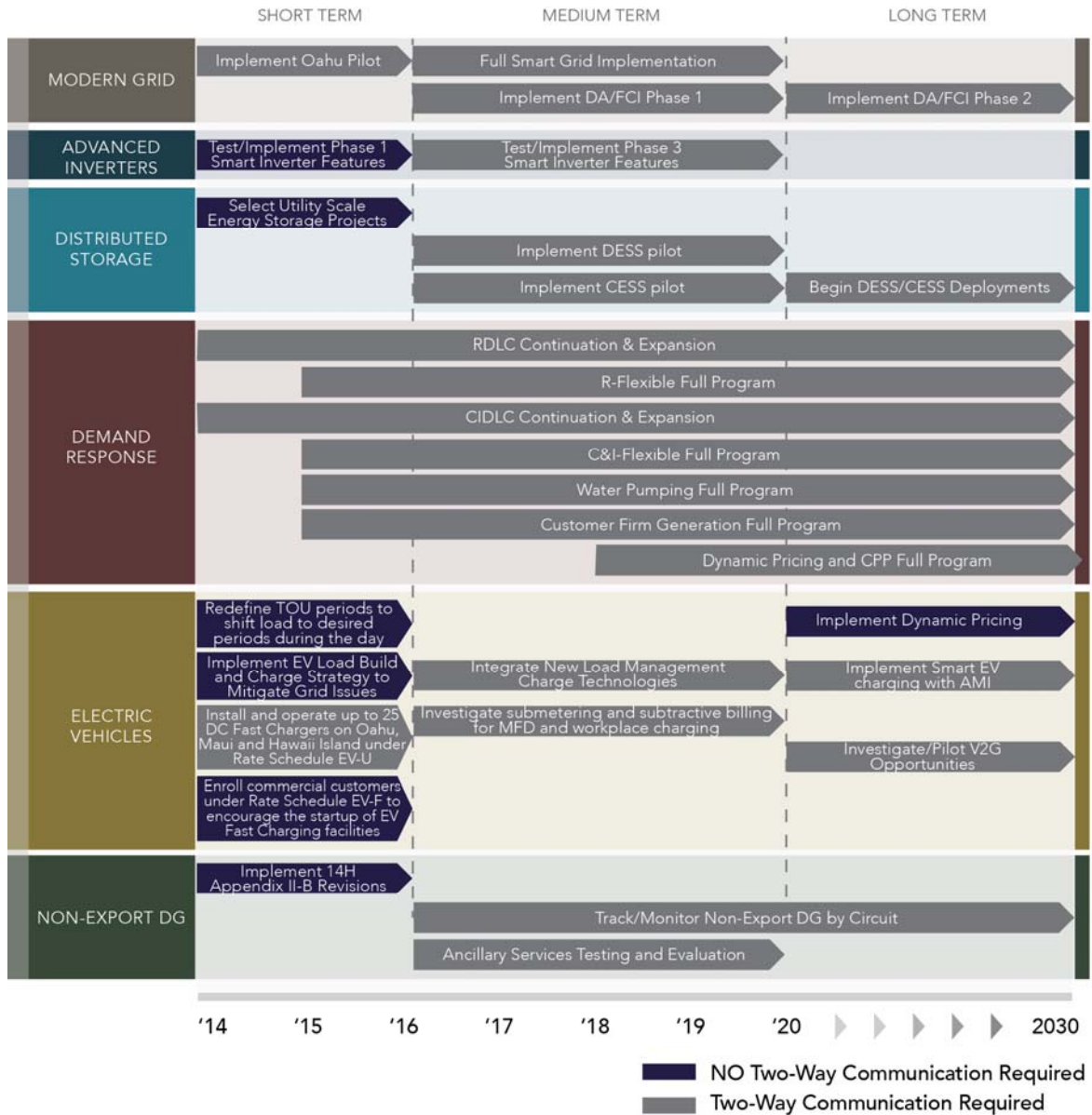

Figure ES-8. Advanced DER Technology Roadmap

The costs to implement the advanced technology roadmap are accounted for in different programs, as shown in **Table ES-7**. In some cases, the costs will be borne by the DG customers; in other cases, the technology is not mature enough for deployment and must be developed and subject to utility-sponsored demonstration projects. (Note: all technologies described in the table will eventually require the two-way communications provided by grid modernization.)

Technologies	Grid Modernization	Integrated Demand Response Portfolio Plan	Demonstration Program	Costs Borne by Customer
Modern Grid	✓			
Two-Way Communications	✓			
Advanced Inverters			✓	✓
Distributed Energy Storage			✓	✓
Demand Response		✓		
Electric Vehicles			✓	✓
Non-Export Systems			✓	✓
Energy Excelerator and Other Pilots			✓	

Table ES-7. Advanced Technology Programs and Costs

The Companies will oversee ADERTUP-related development and the maturation of the associated technologies. A central organization will be the primary point of contact among the Companies, the industry, and interested parties. The Companies will develop laboratories for testing inverters, non-export systems, and EV technologies. Demonstration programs for distributed energy storage and future EV efforts will be conducted. It also will coordinate interactions with the Distributed Energy Resources (DER)-Technology Working Group (DER-TWG), as directed in the Order.

## NON-EXPORT DISTRIBUTED GENERATION SYSTEM

As requested by the Commission, the DGIP specifically presents a non-export DG system as an option to permit more customers to integrate DG than would be possible with full exporting DG systems on a go-forward basis.<sup>13</sup> Non-export DG is generation for customer use only; that is, there is no excess energy transmitted to the power grid. Non-export DG is effectively a load offset, similar to exporting DG, but without the excess generation (i.e., reverse power flow).

Non-export DG has less impact resulting from reverse power flow (and related issues such as TrOV and circuit upgrades) than exporting DG. However, the reduction in load from non-export DG systems will effectively increase the impacts caused by existing exporting DG at the circuit and system levels. There are a number of ways to configure a

<sup>13</sup> Order at 54.

**Executive Summary**  
Non-Export Distributed Generation System

DG system to prevent power export and such systems may or may not incorporate energy storage. These may include small PV systems without storage and with the appropriate inverter controls that have been designed and optimized to address backfeeding and ride-through events while serving customer loads. The Companies have proposed a process for evaluating non-export DG systems for interconnection approval through their Application to modify certain provisions of Tariff Rule 14H, filed June 2, 2014 in Docket No. 2014-0130 (“Docket 2014-0130”).

**Table ES-8** illustrates, from a qualitative perspective, the relative positive and negative technical and economic characteristics, to the customer and the utility, of Non-Export DG, exporting DG, and no DG.

Issue	No DG	NEM Export DG	Non-Export DG
<b>Technical-Utility</b>			
PV Generation Variability Management	N/A	●●	●●
<b><i>Excess Generation Management</i></b>	●●●	●●●	●●
Transient Over-Voltage Impact	●●●	●●	●
System Operations and Dispatch Impact	N/A	●●●	●
Under-Frequency Collapse	N/A	●●●	●
Load Reduction and System Operational Issues	●	●●	●●
Capability to Meet RPS Under System Constraints	●●●	●●	●●●
<b>Technical-Customer</b>			
<b><i>Resiliency to Utility Outages</i></b>	●●●	●●●	●●●
<b>Economic-Utility</b>			
<b><i>Avoided Distribution System Upgrades</i></b>	●●●	●●●	●●
Higher Levels of Distributed Penetration Under Circuit Constraints	N/A	●	●●
Reduces Utility Scale Renewable Curtailment	N/A	●●	●●
Fixed Cost Recovery	●●●	●●●	
Reduce Non-Compliant Interconnections	N/A	●●	●●
<b>Economic-Customer</b>			
Reduced Electricity Costs	●●●	●●●	●●
Customer Cost Recovery	N/A	●●●	●
Customer Capital Expenditure	●●●	●	●●
<b><i>Interconnection Approval</i></b>	N/A	●●	●●●
Maximize PV Generation	N/A	●●●	●●
Customer Flexibility and Choice	●●	●●●	●
<b><i>Volume of Customers that could install DG under Circuit Constraints</i></b>	N/A	●●●	●●●

Bold Italics denotes most significant features ● = Positive effect ● = Negative effect

Table ES-8. Technical and Economic Characteristics of a Non-Export DG System

From a technical perspective, Non-Export DG is similar to other DG solutions. The primary differences are that a Non-Export DG does not operate in parallel with the distribution system, it incorporates energy storage, and it can operate independently of the grid during a failure of utility service or use the grid to supplement the DG or energy storage system and power customer loads. DG systems can be configured or designed to be non-exporting without energy storage but must operate in parallel with the distribution system to maintain consistent power to customer loads during periods of intermittent or no DG output (“Parallel Non-Export DG”). Parallel Non-Export DG is



currently subject to the full screening for interconnection approval, whereas Non-Export DG (i.e., non-parallel) is proposed in Docket 2014-0130 to undergo technical review but is not subject to circuit penetration limits and may be approved for interconnection if proven to be non-exporting.

Because the non-exporting DG systems do not deliver excess energy to the power grid, the utility avoids the cost of system upgrades for transformers and conductors provided that the reduction in circuit-level demand does not cause existing export systems to exceed conductor and transformer ratings. Although a non-export DG system does lead to an increase of backfeed for a circuit due to load offset, it is less than the increase in backfeed for a fully exporting DG system. This allows more customers to install DG than would be possible with exporting systems, enabling greater customer participation as compared with exporting DG systems.

Non-exporting DG systems could lead to simplified and lower rates. The rate structure should incentivize customers to install non-exporting DG with customer energy storage (i.e., customer load shifting). The recommended rate would be a monthly standby rate combined with standard volumetric rates, potentially in a tiered structure, based on customer load profiles. This rate would be justified by recognizing that a properly built non-export system would reduce system peak load and use less of the utility's capital than a full service customer. If a non-export customer did begin to use peak power at the levels of other customers, the non-export customer's rate would simply revert to standard rate classes.

---

## COST ALLOCATION AND RATE REFORM

Reducing costs for customers requires a broad and balanced perspective, not merely a focus on adding more generating capacity. Developing the DGIP required reviewing technical, economic, and policy factors to identify potential solutions. This included evaluating new programs and rate alternatives so that market signals and values are understood. It also included pricing options and rate designs, load response and load shifting, energy efficiency, demand response, and transportation electrification. In addition, close coordination with the PSIPs and the Integrated Demand Response Portfolio Plan (IDRPP) led to tight integration of planning to provide the Commission with a complete picture of the solutions envisioned. While significant changes will be required to achieve higher levels of DG, the Commission recognizes the benefits provided by DG to the participating customers through expanded customer choice and reduced costs.

With the advent of Hawai'i's NEM program, customers who self-generate can reduce their net energy usage, thereby reducing their volumetric charges and their contribution to the fixed costs associated with safely and reliably operating and maintaining the entire system. This phenomenon shifts a portion of the fixed-cost recovery from customers who self-generate to those who do not. As shown in **Figure ES-9**, the increase in lost contributions to fixed per-year costs has increased to \$38.5 million for 2013. The Companies recommend that the current NEM program be transitioned to a solution that is closer to a "Gross Export Purchase" model, which has different rates for export and for consumption. The Companies further recommend adopting a modified Schedule Q and non-export transitional stage as part of the overall strategy.

Specifically, the Companies recommend that this new program include *some or all* of the specific provisions highlighted below. These recommendations are described in more detail in Section 6 of this plan.

- A revised rate, based on a new methodology and assumptions, at which customers will be credited for gross exported energy
- Rate design that possibly includes implementing a time-variant element, a one-time interconnection charge and/or a grid services charge to complement the Gross Export Purchase program
- Curtailment policies and crediting schedules to equitably compensate customers during a curtailment event
- Fair and appropriate "grandfathering" policies for DG customers currently in the NEM program

This would more appropriately allocate costs to those who are causing those costs while allowing customers sufficient choice regarding their sources of electricity.

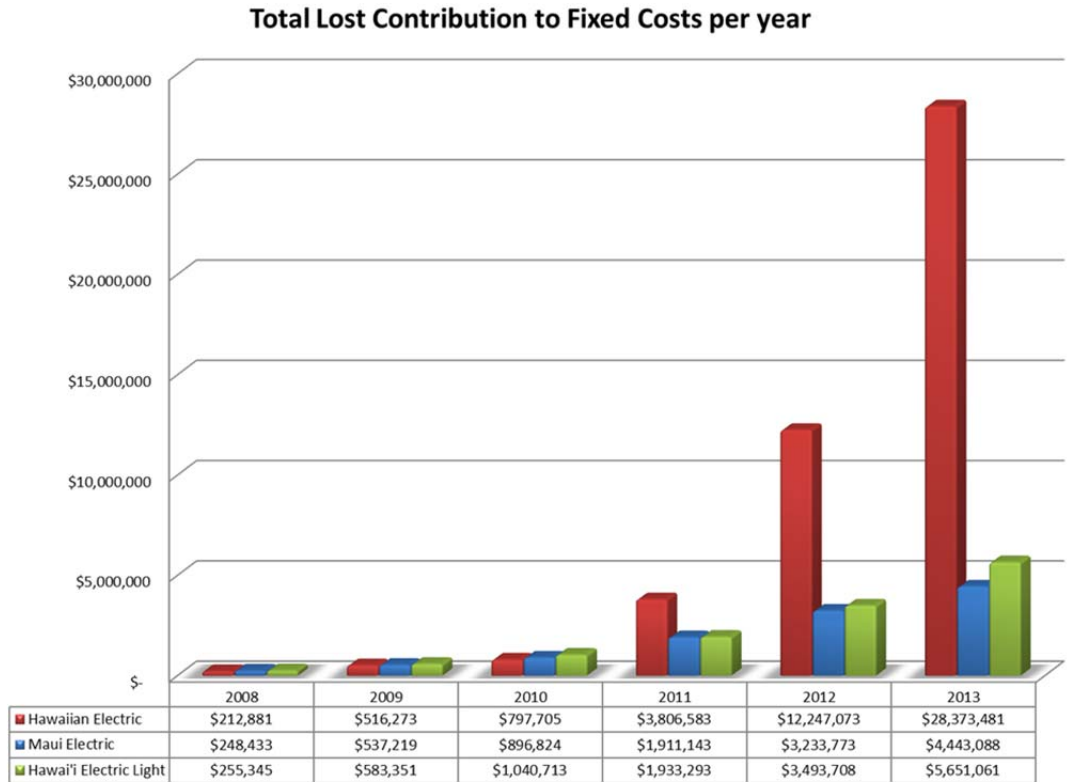

Figure ES-9. Summary of Estimated Increase in Lost Contributions to Fixed Costs

Any new rate solution must be fair and protect all customers against cross-subsidization issues. Moreover, the rate solution must reflect the appropriate regulatory framework. As requested in the Order, cost allocation mechanisms are discussed to demonstrate the fairness of the investments needed to implement the DGIP, including alternatives to the existing NEM program, and ensure that the rates are equitably applied to all customers.<sup>14</sup> A one-time interconnection charge and some form of a grid services charge are introduced as potential mechanisms to allocate DG-specific costs to DG customers. These charges would avoid the cross-subsidization of these charges by full service customers; this approach addresses the Commission's request for cost allocation methods that allocate costs to the customers who bear responsibility for system and circuit upgrade costs.

In evaluating cost allocation mechanisms, the Companies identified several options and their potential impacts on a variety of stakeholders. As summarized in **Table ES-9**, DG 2.0 will consist of a shift from the current NEM program, through an interim transition period, to a complex renewable generation portfolio that incorporates resources owned wholly or jointly by utilities, third parties, and customers.

<sup>14</sup> Order at 55.

The Companies envision a strong, collaborative utility of the future; one in which the traditional lines of utility-owned generation and customer-purchased energy have become blurred or perhaps eliminated. The Companies' vision for such a future includes the DG 2.0 concept which is described herein. The Companies expect that the progression away from the existing system and programs will require further clarification, definition and explanation, and commit to working with the utilities' customers, partners and stakeholders as a key part of this comprehensive effort.

This Page Intentionally Left Blank



	Key Challenges for Hawaii	NEM	Schedule Q	Solutions Needed	DG 2.0
Operational	<ul style="list-style-type: none"> <li>Excess DG generation</li> <li>Ramp up and down</li> <li>Generation flexibility, including sub-hourly</li> <li>Peaking capability</li> <li>Circuit constraints</li> <li>Frequency and voltage</li> </ul>	<ul style="list-style-type: none"> <li>Distorted incentives lead to excess DG generation</li> <li>DG PV is highly variable and intermittent</li> <li>Commitment to clean energy</li> <li>Environmental benefits</li> <li>Prevents efficient system upgrades</li> </ul>	<ul style="list-style-type: none"> <li>Tariff-based service, flexible</li> <li>More equitable rates can lead to sustainable growth rates</li> <li>Signal need for system controls and system upgrades</li> <li>Commitment to clean energy</li> </ul>	<ul style="list-style-type: none"> <li>Operational control</li> <li>Storage</li> <li>Two-way communication</li> <li>Advanced technology</li> <li>Demand response/EE</li> <li>Fast start generation</li> <li>Curtailment</li> <li>Cybersecurity</li> <li>Proactive planning</li> </ul>	<ul style="list-style-type: none"> <li>Reliability and resiliency upheld</li> <li>Innovation with others to improve solutions and costs</li> <li>Flatten load shape</li> <li>Systematic monitoring solutions</li> <li>Incentive to right-size systems</li> <li>Incentive to install storage, and proactively mitigate circuit overload issues</li> </ul>
Policy	<ul style="list-style-type: none"> <li>Cost shifting is occurring</li> <li>Current rules may not work in highly penetrated areas</li> <li>Queues are constrained with multiple programs</li> </ul>	<ul style="list-style-type: none"> <li>Provides customer choice and control</li> </ul>	<ul style="list-style-type: none"> <li>Introduce a modified version as a transition step to DG 2.0</li> </ul>	<ul style="list-style-type: none"> <li>Transition to modified Schedule Q for new systems</li> <li>Launch working group for long-term solution</li> <li>Ensure power quality, reliability, resiliency</li> <li>Consumer protection through DG life cycle</li> </ul>	<ul style="list-style-type: none"> <li>Cost causation</li> <li>Align costs with benefits</li> <li>Provide DG options to more customers</li> <li>Protect interests of all customers</li> <li>Separate generation from consumption</li> </ul>

**Executive Summary**  
 Cost Allocation and Rate Reform

	Key Challenges for Hawaii	NEM	Schedule Q	Solutions Needed	DG 2.0
Economic	<ul style="list-style-type: none"> <li>Allocate costs fairly</li> <li>Pricing signals to optimize cost, reliability, and resiliency</li> <li>Align costs and benefits of DG</li> <li>Lowers bills for all customers</li> <li>Equitable rate structure across customers</li> </ul>	<ul style="list-style-type: none"> <li>Rates difficult to reconcile with other procurement (i.e., highest priced resource—full retail rates)</li> <li>Cost shifting to full service customers</li> <li>Rates are easy to understand</li> <li>Fixed cost recovery not aligned with benefits</li> <li>Can lower overall fuel procurement costs</li> </ul>	<ul style="list-style-type: none"> <li>Rates based on competitive costs</li> <li>Rates easy to understand</li> <li>Does not address revenue erosion issues, only payment rates</li> <li>Lowers DG power procurement costs</li> <li>Can lower overall fuel procurement costs</li> </ul>	<ul style="list-style-type: none"> <li>Transparent queue with pricing signals</li> <li>Pricing to keep utility-scale renewables from competing with DG renewables</li> <li>Equitable rate structure</li> </ul>	<ul style="list-style-type: none"> <li>Market-based pricing signals</li> <li>Compensation for non-energy services</li> <li>Allows for more readily comparable procurement costs</li> </ul>

Table ES-9. Overview of Existing and Future DG Tariffs

# 1. Overview of Distributed Generation

---

## 1.1 STRATEGIC APPROACH TO DISTRIBUTED GENERATION

### 1.1.1 Overview

The dramatic growth of distributed generation (DG) resources—particularly rooftop photovoltaic systems (PV)—has transformed Hawai‘i’s energy ecosystem over the past five years. The Hawaiian Electric Companies (the Companies) envision a future in which the market demand for DG driving this growth remains high. The Companies are committed to meeting this demand under a model that appropriately balances the interests of all customers and stakeholders. Under current policies, network fixed costs are increasingly being shifted to full-service customers,<sup>15</sup> and high levels of DG integration are creating technical challenges for the grid; both of these issues must be resolved to ensure a sustainable future for DG.

In the future, the Companies will address structural constraints on the growth of DG by offering a range of DG options, based on tariff structures that are fair and equitable for all customers, while maintaining the safety and reliability of the power network. Four simple principles, aligned with the core objectives of the Companies' overall vision, will govern this approach to distributed generation:

- Policies should lead to a sustainable set of customer options for DG
- The Companies must be proactive in responding to customer demand for DG
- All initiatives must ensure the safety and reliability of the grid for all customers

---

<sup>15</sup> A "full-service customer" is any residential or commercial customer that imports the entirety of their energy demands from the grid, and does not self-consume or export any energy derived from distributed energy resources co-located with their load.



## 1. Overview of Distributed Generation

### 1.1 Strategic Approach to Distributed Generation

- Rates governing DG interconnections must fairly reflect the value of the power provided from and to the power grid, and must fairly allocate the fixed costs of the grid to all customers

Based on these principles, the Companies will execute a strategy that balances priorities for DG and full-service customers with the Companies' responsibilities and the wider benefits to stakeholders across Hawai'i. If implemented, this strategy will nearly triple the amount of DG installed across the Companies' service territory to over 900MW, ensuring that DG remains a core component not only of the Companies' planning, but also Hawai'i's energy future as a whole.

### 1.1.2 The Case for Change

Hawai'i's high DG penetration is unmatched by any other utility in the nation. The DG growth in the islands has benefitted DG customers, lowering their bills and increasing their choices and control over their energy use. It has brought jobs and innovation to the growing energy industry of Hawai'i, and it has provided a valuable source of renewable energy to the grid, while contributing to environmental goals across the islands.

The current policies governing DG have also created cost and allocation issues for the Companies and their full-service customers.

- The Net Energy Metering (NEM) program, which compensates customers for energy exported onto the grid by DG systems at full retail rates, allows DG customers to shift the burden of operating the grid to full-service customers, while still benefiting from access to the grid's physical infrastructure for import and export of power. By the end of 2013, the annualized shift in the burden of fixed costs from DG to full-service customers due to the NEM program totaled \$38.5 million across all islands. Overall, this represents 1.29% of the Companies' 2013 collected rates. This cost shift has the potential to increasingly affect customer bills in future years as DG capacity grows.
- From the perspective of total system production cost, high levels of DG under the NEM program are more expensive to install and operate than utility-scale renewable energy.
- The need for significant investment in grid modernization has also increased, in part because of the impact of distributed resources on the grid.

In addition to these cost and allocation challenges, the export of excess solar energy to the grid from DG creates significant operational challenges for the Companies. High levels of uncontrolled, unscheduled, and variable energy from DG systems are an increasing threat to the safety and reliability of the power network at the circuit and system levels. In response to circuit-level impacts, the Companies have been forced to restrict the interconnection of DG on certain circuits with high existing levels of DG, leading to a

significant reduction in the rate of interconnections and an increase in customers waiting in interconnection queues. Restrictions on DG interconnections, in turn, have created an unpredictable business environment for external stakeholders, including the Companies' partners in the solar industry.

### 1.1.3 Vision for the Future of DG

The Companies' vision for the future addresses these challenges and ensures that distributed generation plays a central—and sustainable—role in Hawai'i's energy ecosystem. The plan calls for a market-based approach to DG that balances customer choice with the wider impact of DG on stakeholders and the safety and reliability of the power grid.

#### Customers

For customers, this vision represents the Companies' commitment to provide a range of options for accessing distributed generation resources, including dispatchable ("export") DG systems, non-export systems, and community solar alternatives. To enable this access, the Companies will develop tariff structures for DG that are fair and equitable and will strive to meet market demand for DG options under these tariffs. The Companies will also partner with customers to ensure DG systems make positive contributions to the safety and reliability of the grid.

#### Stakeholders

For industry stakeholders, including the solar industry, this vision represents a commitment to creating a sustainable and predictable market for DG resources. For regulators and policymakers, the vision will ensure that DG continues to provide environmental benefits that meet public policy goals.

#### The Companies

For the Companies, the vision represents a goal for developing a range of DG options for customers, while proactively enabling customer participation in a fair, sustainable, transparent, and cost-effective manner.

### 1.1.4 Achieving the Vision for DG

The Companies are committed to enabling high levels of DG growth, but this growth cannot be sustained under the same regulatory, business, and operational policies that have governed growth during the past 5 years. Achieving the vision requires strategic initiatives encompassing regulatory reform, operational improvements, and a range of new DG-related products and services. Together, these initiatives will be applied over

## 1. Overview of Distributed Generation

### 1.1 Strategic Approach to Distributed Generation

the short, medium, and long term to ensure a smooth transition to this new model for DG.

#### 1.1.5 Overview of Strategic Initiatives

##### Implement More Equitable Tariff Structures

Regulatory and policy reform is essential to ensure that the incentives for future DG interconnections are aligned with the interests of all customers. DG growth— incentivized in part by current programs and rate structures— has been beneficial in lowering bills for DG customers and helping reach Hawai'i's environmental goals. However, as DG has become more common, existing programs do not accurately capture and price the benefits that DG customers receive from the grid's physical infrastructure, resulting in an unfair and unsustainable cost shift to full-service customers.

The Companies will develop programs that better reflect the value of DG to the grid and the value of the grid to DG customers. In the short term, this will involve clearing the existing queue of DG projects as circuit- and system-level constraints allow. The Companies will offer new DG applicants a range of options, including the option to connect under a modified "Schedule Q" tariff or a non-export model.

In parallel, the Companies will pursue a longer term solution. As a party to Order No. 32269 issued by the Commission on August 21, 2014, the Companies view this as an opportunity to evaluate a revised set of DG tariffs as part of an approach to distributed generation called DG 2.0. These tariffs may include:

- Utility compensation for excess DG exported to the grid at or near wholesale rates
- One-time interconnection fees for DG customers to ensure fair allocation of DG-related costs
- Fixed standby or capacity charges for DG customers to ensure fair allocation of fixed grid costs

Under revised tariff structures, DG 2.0 will enable the interconnection of export and non-export systems in a manner that fairly allocates costs among all customers and appropriately compensates DG providers.

##### Proactively Mitigate Operational Constraints

High levels of DG penetration can create technical challenges at the distribution level and reliability risks for the overall power system. The Companies are committed to creating a modernized grid capable of integrating DG resources in a safe, reliable, and transparent manner.

The Companies' modern grid platform will require investment in distribution circuit upgrades, system protection mechanisms, and a range of other improvements to integrate additional DG in an economical and safe manner. The plan proactively addresses the technical constraints that limit the rate of DG interconnections and creates a clear, transparent, and predictable process for future applicants – in addition to a sustainable business environment for industry stakeholders.

As noted in the strategic initiative related to tariff structures, the Companies will address the circuit- and system-level constraints that limit DG interconnections in the short term. They will enable interconnections as long as such connections do not jeopardize safety and reliability for customers or impose unreasonable costs on customers. The Companies are working with inverter manufacturers to test and confirm inverter features that will enable an increase in gross daytime minimum load (GDML) limits from 120% to a target of 150%. When additional analysis is required, particularly on highly penetrated circuits, the Companies will provide a clear and transparent path forward for applicants. In the medium and long term, the Companies will work to proactively address circuit- and system-level issues through circuit upgrades and the use of advanced inverter designs coupled with two-way communications, energy storage, and other advanced technologies.

### Develop Additional Products and Services for DG Customers

In keeping with the Companies' commitment to enable DG growth in a fair and sustainable manner, new products and services will be developed that expand customer options for DG. In this way, the Companies will meet customers' increasing expectations and maintain meaningful relationships with both DG and full-service customers. These offerings will include multiple ways of accessing DG resources – including export and non-export systems and community solar – to maximize the benefits of DG across all customers. Customers also will have the option of making positive contributions to the grid through the provision of ancillary and other services from customer-sited storage, electric vehicles, and other emerging technologies.

#### 1.1.6 Timeline for Strategic Interventions

The operational improvements, regulatory reforms, and new products and services at the core of the Companies' vision for DG will require initiatives over the short, medium, and long term, which can be seen in **Figure 1-1**. Collectively, these plans will enable a smooth transition from current DG policies to the DG vision of the future.

## Strategic initiatives will require operational, regulatory, and product changes over three phases

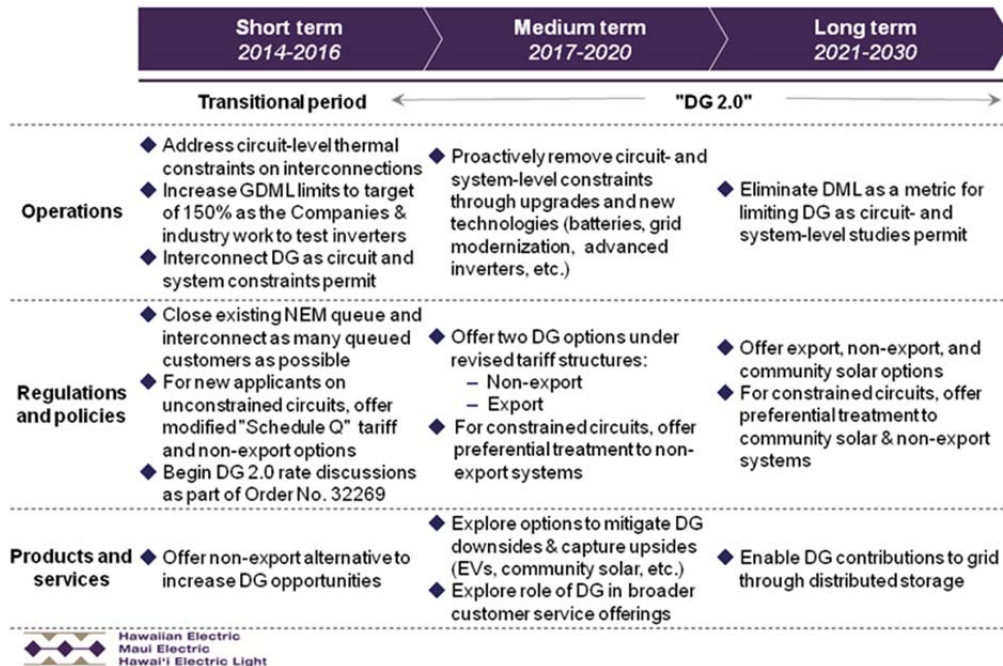

Figure 1-1. Key Strategic Initiatives to Enable DG Growth

### 1.1.7 Strategic Assumptions for Planning Purposes

The material contained collectively in the Power Supply Improvement Plans (PSIPs) and Distributed Generation Interconnection Plan (DGIP), submitted in response to the Commission's Order No. 32053, filed in Docket No. 2011-0206, on April 28, 2014, represent roadmaps to reach the Companies' 2030 vision for distributed generation. As such, they required assumptions about the nature and extent of DG penetration in the future, consistent with the strategic initiatives outlined above.

As part of the DG strategy development process, these assumptions were provided in two main categories:

- DG tariff alternatives ("DG 2.0")
- Market demand projections

These assumptions are introduced at a high level here, and additional information is provided in Appendix B.

## DG Tariff Alternatives

The Companies' strategic vision for DG encompasses alternatives for the rates governing interconnections under DG 2.0. As part of DG 2.0, the current NEM program would be transitioned to a tariff structure for dispatchable DG systems that more fairly allocates fixed grid costs to DG customers and compensates customers for the value of their excess energy.

While the precise nature and timing of this transition will be evaluated as part of the proceeding instituted by the Commission's Order No. 32269, a preliminary set of assumptions regarding DG 2.0 has been made to facilitate the financial and capacity modeling performed in the PSIPs and DGIP. These rate assumptions should not be interpreted as policy recommendations, but they are consistent with the Companies' desire to set fair tariffs that enable customer choice. As such, they adhere to the underlying principles of the Companies' DG strategy, and include the following:

- A fixed charge applied to all customers, allocating the fixed costs of the physical grid in a fair, equitable, and revenue-neutral manner within customer classes
- A fixed monthly charge applied only to DG customers to account for additional standby generation and capacity requirements provided by the utility
- A "Gross Export Purchase model" for export DG. Under this model, coincident self-generation from DG and usage is not metered, and customers sell excess electricity near wholesale rates and buy additional electricity at variable retail rates.

For modeling purposes, DG 2.0 is assumed to apply to all new DG customers from 2017 onward.

## Market Demand for DG

The Companies developed market-driven forecasts for DG demand across Oahu, Maui, and Hawai'i. At a high level, these forecasts represent a view, based on customer economics, of what DG uptake could be as existing DG programs (including NEM) are replaced during the next two years with DG 2.0. Accordingly, the forecasts were based on two distinct phases of DG uptake.

1. From 2014 to 2016, a set rate of interconnection under existing DG programs was estimated based on simplifying assumptions about queue release and the pace of new applications.
2. From 2017 onward, the DG 2.0 tariff structure was assumed to apply across all customer classes. Using benchmarked relationships between the payback period of PV systems and customer uptake rates, the Companies projected market demand for new PV systems among all residential and commercial customer classes.

## 1. Overview of Distributed Generation

### 1.2 Hawai'i Public Utilities Commission Order No. 32053

While these forecasts will undoubtedly shift as more detailed policies are developed, they reflect the Companies' overall commitment to implementing a DG policy that meets customer demand under fair tariff structures. These forecasts also provided an essential starting point for the analysis conducted in the responses to the Order. Among other things, the PSIPs optimized a generation plan on the assumption that DG levels will increase according to these projections (subject to certain controllability and inverter requirements), and the DGIP provides a clear method for identifying and mitigating circuit-level issues that could constrain these levels of DG penetration.

#### 1.1.8 Distributed Generation Interconnection Plan (DGIP)

Consistent with Order No. 32053, this DGIP outlines a coherent set of operational and technological improvements, regulatory reforms, and DG-related products and services that will enable the safe and reliable interconnection of DG resources. Implementation of the recommended actions in the DGIP – together with the recommendations of the PSIPs – will result in increased support for DG at the circuit and system levels, consistent with the Companies' vision for DG and the 2030 Hawaiian Electric System as a whole.

---

## 1.2 HAWAI'I PUBLIC UTILITIES COMMISSION ORDER NO. 32053

Order No. 32053 highlighted concerns about DG with the Companies. Specifically, the Commission instructed the Companies to:

- Be more proactive with analysis and improvements
- Propose technical solutions for the present challenges
- Improve circuit monitoring
- Research advanced inverters and other technologies, and present a plan on how to use and implement new solutions.<sup>16</sup>

The Order reflects concerns about the backlog of interconnection requests. As of June 2014, there were more than 2,800 requests for connection awaiting completion of an Interconnection Requirements Study (IRS) and more than 700 additional requests awaiting mitigations. **Figure 1-2** summarizes the growth in DG capacity for the three companies and shows that more than 50 MW of DG will be installed for 2014.

---

<sup>16</sup> Order at 32-34.

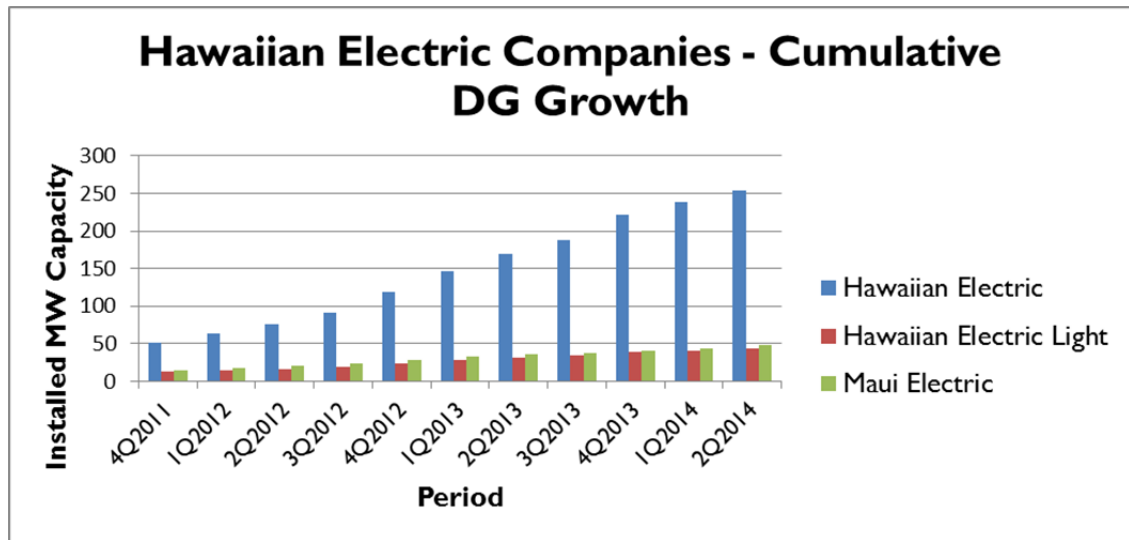

Figure 1-2. Hawaiian Electric Companies DG Capacity, by Year

The Commission has foreseen this change in growth rate, as stated in the Order:

**“Future Outlook**

34. The commission believes it is unrealistic to expect that the high growth in distributed solar PV capacity additions experienced in the 2010–2013 time period can be sustained, in the same technical, economic and policy manner in which it occurred, particularly when electric energy usage is declining, distribution circuit penetration levels are increasing, system level challenges are emerging and grid fixed costs are increasingly being shifted to non-solar PV customers.”<sup>17</sup>

As the Commission has recognized, no other utility in the nation has attained the over 18% daytime DG integration of Hawai'i.<sup>18</sup> This achievement is compounded by the unique issues associated with operating power grids on islands because of the small size of the systems, causing the system reliability to be very sensitive to imbalances of supply and demand. The reserve capacity for dealing with changes in demand is limited to the resources on the islands – the systems cannot have short-term reliance on neighboring systems as is done on the mainland interconnections. The utility must continue to maintain the reliability of the grid. With development of the DGIP, the Companies propose to take significant steps toward increasing DG growth on the islands in a proactive, fair, reliable, and sustainable way.

<sup>17</sup> Order at 49.

<sup>18</sup> Order at 32.



## 1.3 PRINCIPLES GOVERNING DISTRIBUTED GENERATION

In the early phases of DG interconnection, interconnection was driven by one principle— assure safe and reliable interconnection of generating equipment to the distribution circuit— and the features of this principle were codified in the Companies’ Tariff Rule 14H. While this principle continues to dictate the Companies’ processes for interconnection, the significant amount of DG penetration has complicated what was once a fairly straight-forward process. This complexity arises from the fact that distribution circuits today typically have many other DG systems already connected to them, and the impacts of DG are extending beyond the distribution circuit to the area network and to the power system as a whole.

Total installed DG now exceeds the size of the single largest generator on each island grid and has affected the reliability of the distribution circuits and of the system as a whole. These effects must be addressed in the interconnection requirements and by system- and circuit-level modifications. These reliability constraints are discussed further in the following sections.

When DG penetration was low, the amount of investment required by the Companies to perform interconnections and to maintain the overall power grid’s safety and reliability as related to DG was relatively low. As penetration has increased, however, the need for significant investments to support the overall power grid also has increased. Under the existing rates, these costs would be borne either at the time of installation (one-time fee) or by the general rate base.

The cost to modify a circuit to accommodate a high level of DG can be high, which may discourage the installation of DG. The Companies are sensitive to this concern, as a specific customer’s cost does not always reflect the shared cost of an upgrade among all projects on the circuit— the cost is borne by later projects, connecting after a circuit has reached a certain saturation level, while others that contribute to the need for the modification and have or may benefit do not share in the cost. Unfortunately, under current rate structures and programs, there is no means for sharing DG-specific costs among all DG owners.

Applying the costs of DG-specific upgrades to the overall rate base may not be equitable to full-service customers. This unfairness is exacerbated by the current situation, where DG owners generally pay little to no fees for use of the electrical grid, or to cover some of the costs created by high levels of DG, including the increased production costs from the impacts of accepting DG energy, higher production costs that may be incurred to serve DG customers during the evening peak-use period, cost impacts from the variable DG production, and the system modifications required of the Companies to address system reliability impacts from the aggregate of the DG power system.

The impending costs of the necessary upgrades are outlined in the appropriate sections of this DGIP. The rate implications of these costs are discussed in detail in Section 6.

## 1.4 GROWTH RATE AND PENETRATION

The growth rate of DG has been exceptionally high in Hawai'i. **Figure 1-3** illustrates the net system load impact of DG's growth during the past 4 years for Oahu. In June 2010, transmission-connected generation provided more than 1,100 megawatts (MW) of daytime peak generation. During the same time period in 2014, the generation that was not DG provided less than 900 MW. The reduction of more than 200 MW of load during the day's peak solar intensity is due to the growth of DG's reducing demand served by utility-scale generation. This reduction in daytime load has lowered system reliability and is creating the potential for backfeed from the distribution network.

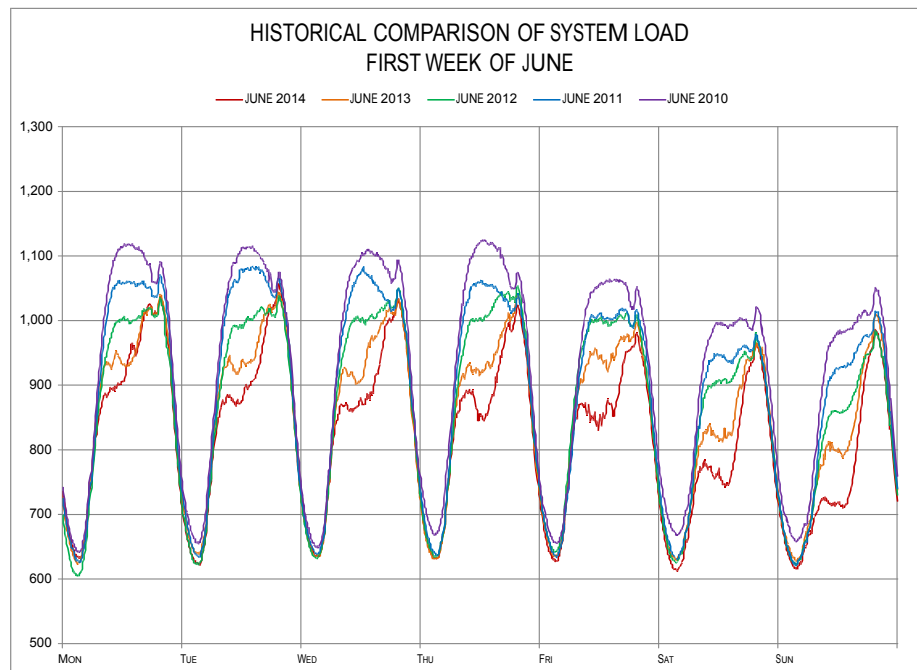

Figure 1-3. DG Growth for Oahu, by Year

A DG forecast based on market conditions and other factors is described in Appendix B. Circuit analyses have been performed for DGIP, with circuit and substation upgrades based on this forecast. **Figure 1-4** illustrates the growth of DG in the past 5 years and projected total DG growth.

## 1. Overview of Distributed Generation

### 1.5 Impacts of Distributed Generation

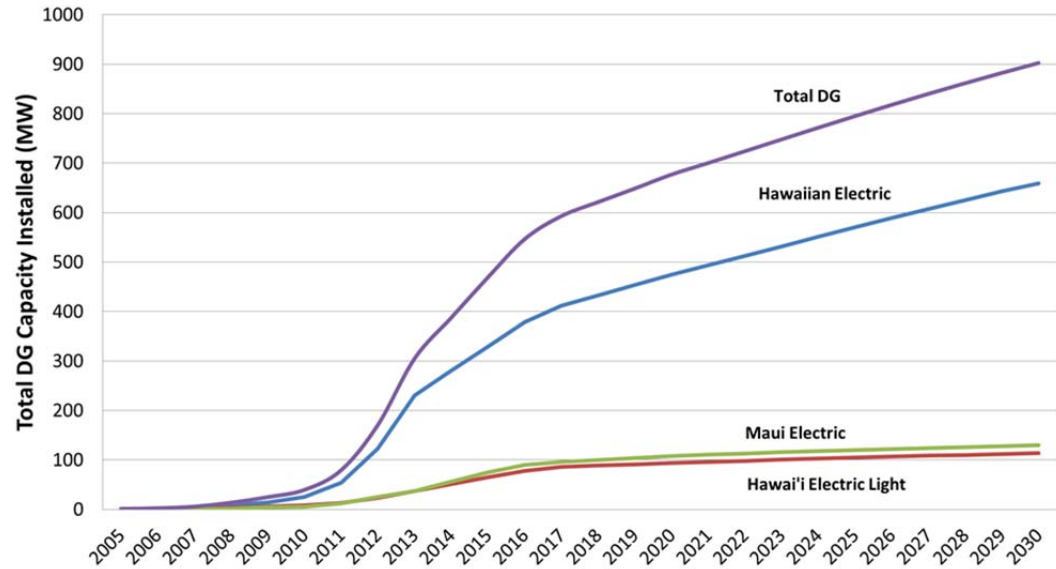

Figure 1-4. DG Growth Projections

## 1.5 IMPACTS OF DISTRIBUTED GENERATION

For several years, the Companies have successfully interconnected thousands of DG installations. Service-level issues—grounding and service equipment upgrades—are specific to the location of each interconnection request and typically are addressed during the supplemental review of interconnection applications.

The current backlog of applications is driven by steady-state and transient circuit issues. Substation/feeder issues can include load tap changer (LTC) controller upgrades for reverse current, transient over-voltage (TrOV), line balancing, and circuit upgrades. Some applications are held up awaiting the results of an Interconnection Requirements Study or by application of the results of the representative circuit studies.

Consequently, the proposed solutions for enabling the addition of more DG address each tier of constraints in the context of the limited ability to handle increased DG and the potential solutions to address specific constraints. Circuit-level analysis has been performed, but this does not fully address the system-level limitations, which must also be considered in the overall planning process. Studies targeting the increased reliability requirements and mitigation for system-level issues have been performed as part of the PSIPs, based on the amount of anticipated DG described in the DGIP and assuming the interconnection ride-through requirements and control capabilities consistent with DGIP recommendations.

## 1.6 SYSTEM-LEVEL IMPACTS

Mitigation of impacts on system reliability require a combination of system operational and resource additions and interconnection requirements and control capabilities. These DG impacts and mitigation measures are discussed below.

### 1.6.1 Transient System Security

Loss of DG during faults and disturbances, if installed according to IEEE 1547 standards, can cause major system instability and potential system failure. A mitigation measure for this issue is for the DG to remain connected and operating through off-normal conditions that occur on the island power systems during system events. This is called “disturbance ride-through.”

In addition to the problems caused by aggregate loss of DG during disturbances, high penetration of DG also affects the effectiveness of the under-frequency load-shed scheme by reducing the amount of demand on the shed circuits, requiring additional blocks of load to be shed, and increasing the number of customers affected. During high DG output, loss of a large generator on the system will require many more customers to incur outages to drop enough load to balance the system; in some scenarios, there may be insufficient load available to prevent system failure. DG-exacerbated load shedding has occurred for each of the companies: on Oahu, June 9, 2014; on Maui, July 12, 2014; on Molokai, June 26, 2014; and on the Big Island, April 2, 2013. During each event, multiple levels of load shedding were triggered, which exceeded the intended system reliability objectives on Oahu and the Big Island. Analyses showed that these outages were exacerbated by the high penetration of DG. Following a distribution fault, all DG tripped at 60.5 Hz, causing outages during the June Molokai event that would not have occurred otherwise. Addressing this issue requires ride-through and a dynamic load-shed scheme that includes the impact on the circuit loads from the output of DG. System-level storage and frequency responsive demand response can provide operating reserves to keep frequency within an acceptable range until backup generation is available. These solutions will be presented in the PSIPs.

### 1.6.2 Steady-State Excess Energy

The energy produced on an island system must be used on the island; therefore, it is necessary to balance power production with the use of power. This means that the power produced by DG will displace power from other sources, forcing power generation offline.

## 1. Overview of Distributed Generation

### 1.7 Substation/Circuit-Level Impacts

Some of the generation power that is forced offline is power that provides system reliability benefits, which the DG power does not provide; thus, a minimum level of power generation must remain operating for the system. If the circuit or system does not have the ability to shift load or energy production by energy storage, an increase in the amount of DG energy exported during the day can exceed the ability of a power system to accept the energy.

The inability to remotely control the power exported from DG leaves the system operator unable to manage system balancing during excess energy conditions and will force the system to operate at risk of failure. If not resolved, this imbalance can cause system failure through the loss of resources.

In addition to excess energy, system operators must deal with the variability of DG output. This variability not only requires the system operator to start and stop generation as needed to balance the system, but also means that the operator is much less certain of how much demand must be served, which reduces the operator's ability to commit to power generation that results in the lowest cost. The power generation online must also be able to ramp up and down fast enough to counter the increases and decreases in DG.

---

## 1.7 SUBSTATION/CIRCUIT-LEVEL IMPACTS

### 1.7.1 Transient Over-Voltage (TrOV)

TrOV (or load rejection over-voltage) occurs when there is excess generation capacity on a feeder section (i.e., power is being exported from the feeder) coinciding with the feeder breaker or other device opening suddenly, leaving less load available than there is DG output on the resulting unintentional feeder island. This can occur as a result of excess generation on a single phase. In some situations, this condition poses a threat to connected customer loads and utility equipment, including failure in the field. This risk can be mitigated by the amount of customer load that is isolated with the DG units, because feeder loads tend to dampen the magnitude of over-voltage.

### 1.7.2 Temporary Ground Fault Over-Voltage

During a ground fault, the neutral of a wye-grounded system can shift, causing a temporary over-voltage on the un-faulted phases. This is an issue for circuits, where 33% of the minimum load is supplied by non-effectively grounded inverter-based DG. Rotating machine output of less than 20% minimum load is desired to suppress ground-fault over-voltage.

### 1.7.3 Transient-Protection Issues

Protection issues, such as uncontrollable islanding, occur when DG continues to energize the power system after the utility source has separated from a DG-sourced region.

Unintentional islanding (even for only seconds), when DG generation on a given circuit exceeds 100% minimum load, presents the following risks:

- Safety issues for utility workers and the public
- Out-of-phase reclosing, which could damage utility equipment, customer load, and the DG system
- Inability to maintain regulated voltage or frequency
- Increase in restoration time following system events and, consequently, reduced reliability.

### 1.7.4 Steady-State Phase Imbalance

The imbalance of generation versus load per phase due to a single phase having more inverters than the other phases can cause a voltage imbalance. American National Standards Institute (ANSI) standards state that a 3% voltage imbalance is the recommended limit. For single-phase residential circuits, phase imbalance may create zero-sequence current issues and ground-fault current may not be effectively mitigated. Also, voltage imbalance affects induction motor loads, potentially reducing efficiency and increasing heating.

### 1.7.5 Steady-State Voltage Issues

#### Load Tap Changer (LTC) Reverse Flow

Steady-state voltage regulations require substation voltage regulators or load tap changers on the substation transformers to maintain voltage within ANSI regulatory limits and tariff requirements ( $\pm 5\%$  of nominal voltage) to customers as loads vary. The controllers on these devices may need to be upgraded to allow reverse flow when DG generation exceeds 100% of minimum load.

#### LTC Cycling

Frequent voltage changes due to variable DG output may increase equipment cycling, such as transformer LTCs, regulator tap changers, and switched capacitor bank activity. More cycling means more maintenance due to increased wear and tear and the potential for a decrease in the useful life of the equipment.

## 1. Overview of Distributed Generation

### 1.8 Customer-Level Issues

#### Voltage Violations

Over-generation that results in excessive reverse power flow can lead to exceeding the acceptable primary voltage range on a circuit, from less than 95% to more than 105% of nominal. Customers may experience high- or low-voltage problems, which can damage appliances and cause power quality issues.

### 1.7.6 Equipment Overload

#### Transformer Overload

Over-generation that results in excessive reverse power flow can lead to overloading the substation transformer and exceeding equipment limitations. Reverse flow during normal system conditions should not exceed the 50% thermal ratings of substation transformers or other electrical equipment to allow load transfer from alternative backup circuit configurations during contingencies.

#### Feeder Overload

Over-generation that results in excessive reverse power flow can lead to overloading of the circuit conductors and exceeding equipment limitations. Reverse flow during normal system conditions should not exceed the 50% thermal ratings of circuit conductors or other electrical equipment to allow load transfer from alternative backup circuit configurations during contingencies.

---

## 1.8 CUSTOMER-LEVEL ISSUES

### 1.8.1 Transient Over-Voltage (TrOV)

TrOV (or load rejection over-voltage) occurs when excess generation capacity on a customer's secondary and distribution transformer suddenly has less load because the feeder breaker or another device opens; this mismatch of load and generation leaves the DG with too little load to absorb its energy. This situation reflects a temporary unintentional island for the customers served from the distribution transformer. In some situations, this condition can pose a threat to connected customer loads and utility equipment served from the same customer transformer.

### 1.8.2 Steady-State Secondary Over-Voltage

Over-generation on the secondary side of the distribution transformer can lead to over-voltage and protection concerns for neighbors who share the same equipment.

Additionally, voltage drop at the DG source during periods of high secondary voltages can prevent inverters from operating.

### 1.8.3 Equipment Overload and Steady-State Voltage Issues

Customer services are not designed for aggregate overloading from DG. Over-generation on the secondary side of the distribution transformer can lead to voltage issues for customers connected to the distribution transformer. To avoid this condition, reverse flow because of DG can be limited.



This Page Intentionally Left Blank

## 2. Distributed Generation Interconnection Capacity Analysis (DGICA)

As part of the Commission's Order No. 32053, a Distributed Generation Interconnection Capacity Analysis (DGICA) is called for, which shall proactively perform simulation based analysis with new models and validation using field measured information to estimate the distribution circuit capacity required to safely and reliably interconnect DG resources. The DGICA identifies the system upgrade requirements needed to increase circuit interconnection capability in major capacity increments. At a distribution circuit level, the Companies' analyses indicate that the ability of a circuit to integrate DG is primarily a function of (1) a TrOV threshold and (2) a thermal limit from backfeeding that allows of a circuit to accommodate the load from an adjacent circuit due to switching actions or contingency situations. The determinants of the amount of DG a distribution circuit can accept are (1) the extent to which issues on the circuits arise and can be resolved; and (2) the extent to which the aggregate amount of DG on distribution circuits causes system-level issues and the extent to which they can be resolved.

For the TrOV issue, the current limit is 120% gross daytime minimum load (GDML). The Companies are engaged in technical discussions with PV inverter manufacturers to explore the expansion of advanced inverter features that would enable the approval of distributed PV projects above the 120% circuit penetration threshold. The Companies envision features that may include expanded ride-through features, improved trip settings, and active power control, and that these features will increase the threshold for which inverters are authorized to interconnect to congested circuits. The Companies will continue to work with industry standards bodies and the manufacturers to advance the design of the inverters to allow for even greater penetration capabilities.

## 2. Distributed Generation Interconnection Capacity Analysis (DGICA)

### 2.1 Technical Impacts

To move beyond the 120% GDML limit, the Companies are implementing the recently filed Distribution Circuit Monitoring Plan and working with inverter manufacturers and NREL and EPRI on testing and standards for advanced inverter functions that could mitigate the TrOV and system-level concerns, as discussed in Section 4, and allow additional DG on these circuits.

A project with NREL and SolarCity in 2014–2015 will use NREL’s Energy Systems Integration Facility capability to test advanced inverter functionality and analyze DG and distribution equipment as it is being used. Tasks that will be completed include (1) testing of DG inverter transient over-voltages, (2) anti-islanding of multiple inverters, (3) advanced inverter volt/VAR support, and (4) bidirectional power flow. The DGICA assumes that advanced inverter functions, field data from circuit monitoring, and/or other mitigations, such as shorting switches or surge arresters, will enable DG penetration to surpass this limit and identifies the next level of constraints in a base case cost model to analyze the potential impact of the Companies’ DG market forecast for DG penetration.

The next level of circuit-level constraints includes the thermal limits of backfeed or reverse current flow caused by DG. For switching actions and contingency situations, the Companies are using a limit of 50% of thermal rating of the conductor or substation transformer to allow load transfers from other circuits.

This analysis also considers: the development of recommended circuit and substation upgrade requirements to enable increased circuit penetration limits. Costs associated with the upgrades are included in Section 3; customer impacts are included in Section 5.

---

## 2.1 TECHNICAL IMPACTS

EPS and Transmission Planning Division have conducted baseline system-level studies to determine system-level impacts of aggregate DG. Representative circuit penetration studies were performed to determine circuit penetration limits of the Company distribution systems. The Hawaii Grid Cluster Evaluation also has been performed in response to the Commission.

These studies indicate that the constraining factors that limit DG under existing technical and operational interconnection requirements are system reliability impacts that arise before most circuit limits are reached. The system reliability constraints are existing issues that must be addressed for the current levels of DG interconnection. Because DG supplants conventional generation without providing equivalent system benefits, overall system reliability may be compromised, as determined by the studies. The DGICA not only focuses primarily on the effects of DG and on potential mitigation measures at the

circuit and substation levels, but also will incorporate recommended changes to the DG interconnection requirements that are essential for mitigating the DG impacts on the system.

This section of the report includes summaries of results from various sources. Full source documents are referenced as appendices throughout.

To adequately assess and stay ahead of high-DG penetration concerns on distribution feeders, a Proactive Approach was developed and presented in the Hawaii Grid Cluster Evaluation that was performed as part of the Companies' Proactive Approach for High Penetration PV Cluster/Circuit Analysis and Mitigation Assessment to enhance planning models and incorporate inverter-based information and distributed PV generators within the utility's baseline modeling and planning practice. The full reports are included in **Attachment A**. A prescribed model validation process has also been introduced for this effort to streamline the data gathering, model build, model validation, and reporting processes to support annual studies and IRS needs. While the Proactive Approach does not replace the IRS, the Proactive Approach Methodology as described in the Hawaii Grid Cluster Evaluation provides a more transparent and consistent scenario-based analysis and reporting capability to help improve high-penetration impact analyses for the electrical system and interconnection evaluations.

### 2.1.1 System Level

As the DG penetration level increases on the distribution system, net daytime system demand will decrease, which creates operational challenges for the future grid. The reduction in demand would require conventional generating units to go offline to accommodate the DG; however, system demand will be reduced during the evening peak because solar power is not available; the system generation must serve the peak demand.

To manage this situation, it is critical to have sufficient ramping capability and online reserves to handle DG variability. If the system is running with few online units to accommodate the DG, unexpected down-ramps of DG will require fast-start generation capability in the fleet to replace possible ramps. Taking the conventional units offline will reduce the overall system inertia, frequency response, and short-circuit strength because DG does not provide any of these attributes. System faults and contingencies will result in greater disturbances with larger voltage and frequency impacts.

Simulation-based models are used to design and assess a system or any part of a network under different steady and time-variant conditions. System network stability is one of the most important criteria for maintaining reliability and represents how stable the system will remain because of changes or disturbances. Models are used to represent the

## 2. Distributed Generation Interconnection Capacity Analysis (DGICA)

### 2.1 Technical Impacts

system's response under steady-state and dynamic (time-transient) conditions. Following are two types of simulations used in this analysis:

1. Steady-state simulations capture the system equilibrium conditions and determine how stable the system is in response to small and slow changes. Most component design specifications are listed for steady-state operations. Steady-state simulations thus model the output of DG systems on 1) a clear sunny day and 2) a cloudy day and compare the two. The Proactive Approach Studies in Attachment A describe steady-state simulations of clusters of circuits and the impact on the circuits as well as the 46-kV subtransmission system and substations serving them.
2. Dynamic analysis looks at time-variant and continuous change due to load or generation in normal and non-normal (contingency) conditions, capturing detailed change response over a period of time for the system, ranging from faults (transients) recovery to normal conditions. For high-penetration-DG systems, dynamic simulations are useful to assess the system's response to voltage, current, and frequency changes under transient conditions (sub-seconds to seconds) or to ramp conditions lasting from minutes to hours. Because dynamic analysis is often the most data and model intensive, dynamic modeling requires very accurate model representations and validation data from the actual infrastructure, including details on relays, inverters, line impedances, switching, measured solar conditions, and geographic locations.

Transient simulations are a subset of dynamic analysis that look at transitory or very short, time-variant change events such as a fault (i.e., line or generator). Transient stability studies for example, assess how quickly a system returns to stable conditions after a sudden fault or change over a prescribed time interval (ranging from sub-seconds to tens of seconds).

Studies on many of these system challenges are included in **Attachment B**.

Circuit penetration studies do not consider issues on the generation and transmission system, such as system reliability and stability and the need for flexible resources for regulation and ramping created by variable generation. These issues are addressed in the system studies and PSIPs.

The PSIP analysis incorporates mitigation measures already identified and in the Companies' near-term plans, including protective relay upgrades and a dynamic UFLS for substations, as well as the requirement to expand SCADA to stations.

#### 2.1.2 Circuit Level

In addition to the system-level constraints previously discussed, the high level of DG penetration on circuits that results in sustained reverse power flow or backfeed through

distribution substations is another factor. The concern is whether electrical system components and protection controls can operate properly under reverse power conditions. In general, electric systems are designed with more capacity near the source and less capacity as loads are dispersed off the lines. When new generation sources are added in the weaker areas of the system, causing power to flow from weaker areas to stronger areas, voltage rise becomes an issue. In addition, line losses can increase and system capacity can decrease, especially in the weaker capacity areas of the system which have more DG than load. A study performed by the National Renewable Energy Laboratory (NREL) for Oahu (included in **Attachment C**) discusses how LTCs could regulate system voltages improperly if the correct controls are not in place. Generally, under backfeed conditions, if reverse power flow cannot be sensed, the LTC will continue to regulate, resulting in potential voltage violations on the system. The same concern is applicable to line voltage regulators on the system.

The mitigations necessary to address these issues are as follows:

- Limit backfeed through substation transformers and primary lines to 50% of capacity and to allow contingency switching scenarios, prevent equipment overload, and reduce the risk for excessive voltage rise
- Upgrade LTCs and voltage regulator controls by providing bi-directional settings and capability when backfeed is encountered
- Upgrade protection devices to detect and respond properly to reverse flow when required.

Three electrical clusters on the island of Oahu were assessed using Proactive Approach in the Hawaii Grid Cluster Evaluation. To determine the limitations of the distribution circuits, validation processes were performed for the transformers. The effects on the system were identified, at current DG penetration levels and at future scenario levels.

The simulation results show the following:

- Existing backfeed through some circuits exceeds the limits
- Existing DG penetration levels exceed the 5% fault current rise limit
- Additional bi-directional protective monitoring devices are recommended.

Circuit penetration studies were conducted for Hawaiian Electric and Hawai'i Electric Light, and the circuit results for individual, project-specific IRSs for Hawaiian Electric, Maui Electric, and Hawai'i Electric Light were compiled. A full summary of the results of the circuit penetration studies is included in **Attachment D**.

For Hawaiian Electric, the studies for four representative distribution substations and feeders evaluated the impacts of residential rooftop solar systems (single-phase and three-phase) on Hawaiian Electric's distribution system. The studies analyzed steady-

## 2. Distributed Generation Interconnection Capacity Analysis (DGICA)

### 2.1 Technical Impacts

state power flow and voltages, system protection, flicker, and unintentional islanding impacts caused by the rooftop solar. Redacted versions of these studies are included in **Attachment D**.

Each feeder analyzed had varying amounts of DG penetration, as shown in **Table 2-1**. Circuit penetration is expressed as a ratio of generation to gross daytime minimum feeder load (i.e. without DG generation) in percentage and shows daytime minimum load and existing penetration level on studied feeders. **Table 2-1** summarizes the results of these studies.

Circuit	Minimum Daytime Load (kW)	NEM (kW)	FIT (kW)	Percent Penetration Gen to Min Load
H47-2	1,573	710	2,500	204%
H158-1	1,540	961	0	62%
H159-1	306	285	0	93%
H159-2	2,130	2,784	0	130%
H158-2	3,286	2,739	0	83%
H132-1	3,586	784	1,550	160%
H132-2	2,161	857	3,150	417%
H110-1	2,504	1,438	475	76%
H111-2	3,654	1901	4,025	162%
H111-1	1,483	51	0	3%

Table 2-1. Existing Penetration Levels on the Studied Circuits

### Steady-State Analysis

Power flow analysis did not indicate any significant concerns related to primary voltage issues up to very high DG penetration levels. Thermal loading is defined as the maximum current that a conductor can transfer without overheating, and is based primarily on the conductor sag. Thermal loading limits for each circuit are reached when penetration levels exceed a point where reverse power flow exceeds the conductor rating. In addition, substation transformer capacity is a limiting factor when compared to circuit conductor capacity, which is the calculated allowable amperage the conductor can carry before experiencing damage. To maintain planning and operational flexibility of the distribution system, facility loadings will carry enough margins to accommodate switching operation and load transfer under emergency conditions. The margin would depend on the configuration and size, but is limited to 50% of capacity to generalize for the whole system. For example, a typical distribution transformer is rated at 10 MVA. Under the 50% planning criterion, the maximum allowable reverse flow through a transformer (typically two circuits per transformer) is 5 MVA. This consideration could limit the penetration for specific circuits.

Distribution circuits that do not have large conductors for their backbone or that are operated at 4 kV rather than 12 kV may encounter steady-state voltage issues at lower penetration levels. In general, limiting the thermal flow through the circuit main conductors will help to mitigate high steady state voltages encountered on weaker circuits because of the presence of DG. Voltage imbalance must be monitored closely for these circuits as well as for circuits that have three-phase induction motor load because the studies show that voltage imbalance increases with DG penetration.

As DG penetrations increase, the Companies can expect voltage regulation issues to occur on weaker circuits, which would require distribution system upgrades on the primary and secondary circuit. For example, increased DG penetration can cause service voltages to exceed acceptable ranges, causing inverters to trip offline unexpectedly.

In addition to primary-level issues, secondary over-voltage and thermal issues are of concern. As mentioned under system-level issues, when generation sources are added in the weaker areas of the system, causing power to flow from weaker areas to stronger areas instead of from stronger areas to weaker areas as traditionally designed, voltage rise can become an issue. When the DG is high enough to supply most of the load, the voltage level can rise at the distribution transformer.

Secondary over-voltage occurs because service conductors are usually undersized, with high impedance, for the length of the run and size of the DG system. DG inverter voltage will rise as DG production increases, but must rise higher than acceptable levels to overcome the high impedance. In some cases, voltage at the DG inverter can rise until its over-voltage trip setting limit is reached, and it shuts off.

Distribution transformers will also reach capacity limits, and will require upgrades due to oversizing of DG systems from shared distribution transformers. For TSF-H158 and H159, approximately 280 distribution transformers will be over capacity limits at 371% NEM penetration, which is 39% of the distribution transformers served from the TSF-H158 and H159 circuits.

Solutions for secondary over-voltage and thermal concerns include the following:

- Limiting the DG system size to customer's peak demand
- Advanced inverter requirements, including adjustable or fixed power factor controls
- Upgrades to customer distribution transformers and secondary conductors.

Maximum allowable penetration for several areas was identified in the representative studies, and is shown in **Table 2-2**.



## 2. Distributed Generation Interconnection Capacity Analysis (DGICA)

### 2.1 Technical Impacts

Circuit	Maximum Allowable PV (MW)	GDML Penetration (%)
H47-2	7.0	300%
H158-1&2 & H159-1&2	27.0	371%
H132-1&2	12.1	210%
H111-2	12.4	275%

Table 2-2. Maximum Allowable Penetration Levels Identified

#### LTC Cycling Impacts

The studies analyzed LTC cycling impacts in detail. Annual analysis indicated up to a 185% increase in LTC cycling due to cloud cover events. Additional recording and monitoring of LTC and line regulator tap movement are recommended to obtain a more accurate depiction of the impacts of DG on the system at the current level of interconnection and as penetration levels rise. Increased LTC cycling potentially can lead to shorter maintenance cycles (i.e., more frequent maintenance) and shorter overall lifecycles.

#### Voltage Flicker

Flicker is defined as an impression of unsteadiness of visual sensation induced by a light stimulus whose luminance or spectral distribution fluctuates. A rapid change in voltage, or voltage fluctuation, causes flicker for customers on a circuit. For solar PV systems, flicker could be caused by a change in power output when a system switches from on to off and off to on as cloud cover comes and goes.

Analysis indicates that flicker is not expected to be a limiting factor at high DG penetration levels. Flicker due to DG penetration on a circuit also depends on the existing level of flicker on the circuit. Monitoring at the circuit level when DG penetration equals the circuit load is recommended to obtain a base flicker measurement for that level of DG on different types of distribution circuits, such as long, short, small wires, all overhead versus underground, and so on. The Companies will closely monitor flicker on a diverse set of circuits to establish baseline flicker levels and to validate the study's conclusions. These efforts are outlined in the recent Distribution Circuit Monitoring Plan.

As PV penetration increases on the system, the Companies will have a recorded baseline of voltage flicker across the system for existing DG penetration. Based on the IEC 61000-3-7 standard, short-term flicker ( $P_{st}$ ) will be limited to 0.9 and long-term flicker ( $P_{lt}$ ) will be limited to 0.7 for the medium distribution system, where  $P_{st}$  is measured over a 10-minute time interval and  $P_{lt}$  includes 12  $P_{st}$  time intervals. IEC 61000-3-7 superseded the IEEE 519 and IEEE 1453 standards to allow for a more in-depth discussion of the voltage flicker issue and to include the definition of a flickermeter. IEEE 1453 states that for events that occur once per hour or more, using a flickermeter, and the subsequently

derived  $P_{st}$  and  $P_{lt}$  terms, better characterizes the impact than the previous standards. It also states that the previous flicker standards are still useful for infrequent events (i.e., less frequent than once per hour).

Depending on where the baseline measurements fall in comparison to the limits, the Companies can predict the amount of additional DG the circuit can integrate before flicker becomes an issue. Flicker is currently not a problem, and analyses indicate that it will not become a problem; however, such analyses must be conducted periodically. If flicker were to become an issue, the following are potential mitigations are as follows:

- Increase the circuit stiffness by upgrading conductors
- Allow DG to operate at an off-unity power factor
- Provide energy storage
- Install static VAR compensators to provide fast-acting reactive power.

### Protection and Short-Circuit Analysis

In general, protection review did not identify any short-circuit or coordination issues for the circuits studied. Sympathetic or nuisance tripping due to reverse flow from a fault on an adjacent circuit was not identified as an issue for the studied circuits.

Tap fuses will be monitored and replaced as DG penetration increases on the distribution system. Based on the results of the studies, the Companies will avoid implementing low-set instantaneous overcurrent elements on circuits where there is the potential for reverse flow. Also, mid-line protection devices likely will experience nuisance tripping well before the circuit breaker. The Companies must evaluate the potential for this issue to occur on circuits on the distribution system with mid-line devices and consider removing the devices or installing directional operation capability.

Over-current protection desensitizing is of concern. The desensitizing of over-current protection can result from solidly grounding DG in distribution systems and allowing potentially large fault currents to flow through the transformer neutral. To mitigate this concern, it is necessary to provide effective grounding. This solution may require the addition of grounding banks to make DG systems effectively grounded and to aid in preventing ground-fault over-voltages on the system.

### Unintentional Islanding

There are two primary concerns about unintentional islanding: (1) safety and (2) load rejection over-voltage.

It was determined that the chances of inverters staying energized in an islanded condition are very low. Safety risks due to failure of anti-islanding detection from inverters can be alleviated to a large extent by requiring inverters to have active anti-

## 2. Distributed Generation Interconnection Capacity Analysis (DGICA)

### 2.1 Technical Impacts

islanding protection. This will be further validated with scheduled lab testing with NREL.

The studies performed identified load rejection over-voltage as a concern at high penetration levels. This analysis was challenging in the representative studies. To study load rejection over-voltage, modeling tools must be able to adequately capture the electromagnetic transients in a power system; the inverter models must have the same capability.

The results were compared with the Information Technology Industry Council (ITIC) (formerly known as Computer Business Equipment Manufacturers Association (CBEMA)) curve, which limits various levels of high voltage over time to prevent damage to 120-volt customer equipment. The over-voltage duration observed in these studies depends on the inverter over-voltage protection settings which typically range from instantaneous to 10 cycles, as required by IEEE 1547. These over-voltages are referred to as transient over-voltage (TrOV).

**Table 2-1** and **Table 2-2** present the results of the TSF-H158 and H159 and H111-2 studies, respectively. **Table 2-3** modeled an IEEE 1547-compliant inverter where disconnection time is 10 cycles after detection of an over-voltage condition, as well as an inverter with an instantaneous trip. The TSF-H158 and H159 study involved only NEMs; the TSF-H132 and H111-2 studies involved a mix of larger FIT projects and NEMs.

Scenario	Penetration	Duration (milliseconds)	TrOV Magnitude
A	100%	160	96%
B	120%	160	100%
C	130%	160	106%
D	140%	160	120%
E	150%	160	139%
F	200%	160	168%
G	300%	1.9	244%

1. Scenarios A-E are results with inverter disconnection time of 10 cycles.

Table 2-3. TSF-H158 and H159 TrOV Study Results

Scenario G has an inverter with voltage detection and instantaneous response and will result in TrOV of 244% for <0.1 milliseconds. The duration of voltage greater than 120% is 1.9 milliseconds, as shown in the table. **Table 2-4** and **Table 2-5** modeled an inverter with an instantaneous high trip.

Scenario	Penetration	Duration (milliseconds)	TrOV Magnitude
A	100%	--	108%
B	111%	--	110%
C	143%	--	119%
D	200%	--	123%
E	333%	--	144%
F	1000%	1.6	162%
G	No Load	1.6	163%

Table 2-4. H111-2 TrOV Study Results

Scenario	Penetration	TrOV Magnitude	TrOV Duration (milliseconds)	MAX TrOV Magnitude	MAX TrOV Duration (milliseconds)
A	100%	65%	160	104%	<0.1
B	120%	75%	160	114%	<0.1
C	150%	95%	160	133%	<0.1
D	200%	100%	160	142%	<0.1
E	300%	120%	160	146%	<0.1
F	400%	>120%	3.6	147%	<0.1

1. In Scenario C, TrOV was greater than 120% for 2.0 milliseconds.
2. In Scenario D, TrOV was greater than 120% for 2.1 milliseconds.
3. In Scenario F, the instantaneous voltage fast trip responded.

Table 2-5. TSF-H132 TrOV Results

The results of the three studies vary, but the maximum level of penetration that did not indicate a TrOV concern was 130% of GDML. This could result from both consultants developing a generic model design or could be directly linked to individual circuit equipment, configurations, and load balance. Developing generic guidelines to address this issue is difficult because the TrOV is highly dependent on the types of inverters on a circuit; thus, each type of inverter must be tested, which is costly. If DG penetration levels continue to increase, it will be necessary to continually evaluate the risk of TrOV.

In addition, the difference in the results from the TSF-H132 and the TSF-H158 and H159 studies is due to the large number of FIT projects on the TSF-H132 circuit relative to the number on the TSF-H158 and H159 circuit. Also, the phase and inverter loads on TSF-H158 and H159 were modeled as balanced, whereas the imbalance in load and inverters, by phase, was accounted for in TSF-H132. For both TSF-H132 and TSF-H158 and H159, fast-trip inverter functionality was included, but the inverters did not see the 155% trip

## 2. Distributed Generation Interconnection Capacity Analysis (DGICA)

### 2.1 Technical Impacts

trigger and respond until higher levels of DG penetration, such as 300% and 400%, were achieved. The inverters tripped on frequency until those levels were reached.

The Companies currently use a threshold of 120% GDML to limit the occurrence of TrOVs. Increasing to this threshold will require inverters with an instantaneous high-voltage trip (a stipulation requesting this new level will be developed).

The decision to move beyond the 120% GDML limit will be based on results from projects with EPRI, NREL, and SolarCity in 2014–2015 to test advanced inverter functionality and analyze DG and distribution equipment as it is being used. Advanced inverter functions, field data from circuit monitoring, and/or other mitigations, such as load switching or surge arresters, will be required to surpass this limit.

### Interconnection Requirement Study (IRS) Results

Many IRSs for customer interconnection applications have been completed for the Companies, and include analyses similar to those for the circuit penetration studies, although typically the IRS analyses are for one specific proposed project.

Recommendations from the IRSs include the following, which provide insight into the types of technical issues identified from the studies:

#### *Hawaiian Electric*

- Direct transfer trip (DTT) is recommended in some circumstances to prevent unintentional islanding. Time-coordinated DTT to mitigate load rejection TrOV may cause issues in coordinating substation arc flash mitigation and timing of the DTT signal.
- Specify ground transformers specified to mitigate ground-fault over-voltage
- Make required minor adjustments to Hawaiian Electric’s existing phase and ground relays and reclosers.
- Modify and replace controls for LTC or voltage regulators
- Modify under- and over-frequency ride-through requirements
- Reconductor circuits
- Operate DG systems at off-unity power factor

#### *Maui Electric*

- Grounding transformers specified
- DTT recommended
- Minor adjustments to existing Maui Electric phase and ground relays and reclosers are required
- New reclosers are required

- Modify and replace controls for LTC or voltage regulators
- Modify over- and under-voltage ride-through requirements
- Upgrade site transformer capacity
- Operate at off-unity power factor
- Lower tap of project site transformer or substation LTC tap
- Reconductor
- Install Shorting Switch
- Specify fast-trip inverter capabilities

#### *Hawai`i Electric Light*

- Perform Load balancing
- Modify LTC control
- Specify grounding transformers
- DTT recommended in some circumstances
- Live-line block closing
- Make required minor adjustments to existing Hawai`i Electric Light phase and ground relays and reclosers
- Modify under- and over-frequency ride-through requirements
- Reconfigure circuit to mitigate voltage issues
- Add new substation

In general, steady-state load flows did not indicate issues due to capacity or voltage; in some studies, excessive TrOV and GFOV were identified as possibilities. DTT, surge arresters, fast trip inverters, and shorting switches have been identified to reduce likelihood of TrOV impacts. To mitigate GFOV, grounding transformer banks were specified. For protection, if out-of-phase reclosing was a study outcome, a recommendation to increase reclosing delays was included. When unintentional islanding was identified as a concern, DTT was recommended. Disabling bi-directional controls on regulators and LTCs was recommended when reverse flow was detected.

#### Data, Models, and Criteria

Analysis of specific DG projects (or clusters of DG projects) depends heavily on the quality of the model, data, and circuit details. **Attachment E** describes the types of input data required for the studies and the application of the data in the modeling analysis.

## 2.2 CIRCUIT UPGRADE REQUIREMENTS

In addition to the studies already completed for the Companies, additional data and analyses were completed in preparing this DGIP. The new analysis expands on the current constraints related to capacity. The data compiled include the following:

- Installed, approved, and in-process DG
- Forecast DG and forecast demand, by circuit and substation transformer
- Daytime minimum and maximum load, by circuit and substation transformer
- Existing substation transformer and main circuit backbone capacity, as well as a 50% planning limit to allow for contingency switching between circuit ties
- Calculations on the remaining existing substation transformer capacity and circuit backbone capacity
- Completed studies that have been completed for each circuit and any mitigations recommended in the studies
- Mitigations and costs, separated into short-term (2016), mid-term (2020), and long-term (2030) planning horizons.

Forecast load and DG for each company play a major role in determining the upgrades required over each time period. DG penetration assumptions are based on preliminary market-driven forecasts for DG uptake across Oahu, Maui, and Hawai'i, based on "DG 2.0" tariff reform in 2017. **Table 2-6** presents these growth assumptions, and their derivation is described in Appendix B. For the purposes of the DGIP circuit capacity modeling, growth rates are applied uniformly across each company, without detailed projections by circuit or by specific areas.

Company	Load Growth			DG Growth		
	2014-2016	2017-2020	2021-2030	2014-2016	2017-2020	2021-2030
Hawaiian Electric	1.27%	0.72%	-2.80%	28.2%	6.75%	3.72%
Maui Electric	1.05%	2.14%	-0.42%	38.9%	4.69%	1.83%
Hawai'i Electric Light	-0.47%	0.73%	-0.10%	24.8%	4.86%	1.83%

Table 2-6. DG and Load Growth Projections

In evaluating backbone circuit capacity, substation transformer capacity, projected load growth, and projected DG growth for each company, several observations were made

**2. Distributed Generation Interconnection Capacity Analysis (DGICA)**  
2.2 Circuit Upgrade Requirements

related to reaching capacity limits and GDMLs. The full circuit and substation analyses are located in **Attachment F**. The results are summarized in **Tables 2-7** through **2-10**.

<b>Company</b>	<i>Total Substation Transformer Capacity at 50% (MVA)</i>	<i>Existing DG on Substation Transformers (MW)</i>	<i>Existing Remaining DG to 50 % Substation XFMR Rating (MW)</i>	<i>Number of existing substation transformers with 50% rating exceeded</i>	<i>Number of existing substation transformers with DG &gt; GDML</i>
Hawaiian Electric	909	269	1,038	0	52
Maui Electric	204	56	263	0	5
Hawai'i Electric Light	265	51	307	0	9
<b>Total</b>	<b>1,378</b>	<b>377</b>	<b>1,609</b>	<b>0</b>	<b>66</b>

Table 2-7. Existing Capacity Study Results—Substation Transformers



**2. Distributed Generation Interconnection Capacity Analysis (DGICA)**  
2.2 Circuit Upgrade Requirements

This Page Intentionally Left Blank

2. Distributed Generation Interconnection Capacity Analysis (DGICA)  
2.2 Circuit Upgrade Requirements

Company	2016			2020			2030		
	Remaining DG to 50 % Substation XFMR Rating (MW)	# of substation transformers with DG > GDML	# of substation transformers with 50% rating exceeded	Remaining DG to 50 % Substation XFMR Rating (MW)	# of substation transformers with DG > GDML	# of substation transformers with 50% rating exceeded	Remaining DG to 50 % Substation XFMR Rating (MW)	# of substation transformers with DG > GDML	# of substation transformers with 50% rating exceeded
Hawaiian Electric	996	68	0	912	99	0	642	150	0
Maui Electric	232	19	1	224	22	1	198	31	1
Hawai'i Electric Light	286	22	1	274	29	1	257	34	1
<b>Total</b>	<b>1,514</b>	<b>109</b>	<b>2</b>	<b>1410</b>	<b>150</b>	<b>2</b>	<b>1,096</b>	<b>0</b>	<b>0</b>

Table 2–8. Projected Capacity Study Results—Substation Transformers

Company	# of Circuits	Total Circuit Backbone Conductor Capacity at 50% (MVA)	150% GDML DG Capacity (MW)	Existing DG (MW)	Remaining DG Capacity 150%GDML (MW)	Number of existing circuits with 50% rating exceeded	Number of existing circuits with DG > GDML	Number of circuits Less Than 100%GDML	Number of circuits 100%-120%GDML	Number of circuit 120%-150%GDML	Number of circuits exceed 150%GDML
Hawaiian Electric	332	1,303	597	269	333	0	108	224	34	40	34
Maui Electric	100	362	173	56	117	0	11	85	6	4	3
Hawai'i Electric Light	119	606	141	51	93	0	18	101	4	10	4
<b>Total</b>	<b>551</b>	<b>2,271</b>	<b>911</b>	<b>377</b>	<b>543</b>	<b>0</b>	<b>137</b>	<b>410</b>	<b>44</b>	<b>54</b>	<b>41</b>

Table 2–9. Existing Capacity Study Results—Circuits

## 2. Distributed Generation Interconnection Capacity Analysis (DGICA)

### 2.2 Circuit Upgrade Requirements

Company	2016		2020		2030	
	<i>Remaining DG Capacity 150%GDML</i>	<i># of circuits with 50% rating exceeded</i>	<i>Remaining DG Capacity 150%GDML</i>	<i># of circuits with 50% rating exceeded</i>	<i>Remaining DG Capacity 150%GDML</i>	<i># of circuits with 50% rating exceeded</i>
Hawaiian Electric	305	0	261	0	114	11
Maui Electric	90	1	91	1	70	2
Hawai'i Electric Light	74	1	66	1	53	1
<b>Total</b>	<b>469</b>	<b>2</b>	<b>418</b>	<b>2</b>	<b>238</b>	<b>14</b>
Notes (1)	In 2030, 8 out of 11 Hawaiian Electric circuits exceeded the 50% circuit backbone rating but were not identified in the DGIP budget for reconductoring because they are covered in the asset management program for 4kV conversion program.					

Table 2-10. Projected Capacity Study Results—Circuits

Based on study results, DG effects on the subtransmission, substation, circuit, and local levels and the potential identified mitigations to address them are listed in **Table 2-11**.

Effect of DG	Mitigation Activity
Reverse flow through the substation transformer	Upgrade LTC controls
Reverse flow through a circuit with voltage regulators	Voltage regulator control upgrade
DG greater than 50% capacity of backbone circuit rating and/or voltage issues	Upgrade line capacity
DG greater than 50% capacity of substation transformer rating	Upgrade substation transformer and switchgear capacity
DG greater than 33% GDML for applicable circuits	Add grounding transformer on circuit (For pre-determined circuits)
DG greater than 50% GDML for 46-kV sub-transmission lines	Add grounding transformer on 46-kV line
Distribution transformer capacity exceeded and/or localized high voltage on the secondary	Upgrade distribution transformer capacity; new pole and secondary also may be needed

Table 2-11. DG Effects and Mitigation Activities

Reverse power flow through the voltage regulators and substation transformer LTCs means controls must be replaced to operate properly under reverse-flow conditions. Existing voltage regulators for each company were included as needing the controls replaced, which is expected to occur in the short-term planning horizon.

Circuits and substation transformers are flagged that have reverse power flow at the 50% planning capacity limit to allow for load transfer during contingencies.

Conductor upgrades and transformer upgrades are highly dependent on location. The data presented are based on the assumptions of uniform growth in load and the DG forecasts described in Attachment J. Realistically, the upgrades may be more or less, and will be determined through proactive planning and program management that will rapidly screen and interconnect groups of DG resources and proactively assess and mitigate transmission and distribution impacts due to high penetrations of DG.

Distribution transformer upgrades on each circuit were estimated based on sample analyses of some Hawaiian Electric circuits that determined a correlation between % of transformer upgrades and circuit GDML. The estimate was adjusted for the other islands based on average customers per transformer.

**2. Distributed Generation Interconnection Capacity Analysis (DGICA)**  
2.2 Circuit Upgrade Requirements

This Page Intentionally Left Blank

# 3. Distributed Circuit Improvement Implementation Plan (DCIIP)

As part of the Commission’s Order No. 32053, a Distribution Circuit Improvement Implementation Plan (DCIIP) is required, which shall summarize the specific strategies and actions, including associated costs and schedule, to implement circuit upgrades and other mitigation measures. These measures will increase the grid capacity and enable the interconnection of additional DG. This plan includes a prioritization of proposed mitigation actions as follows:

- Focus on the immediate constraints for interconnection of additional DG
- Analyze the costs and benefits of proposed mitigation strategies and action plans
- Discuss how distribution system design and operational practices could be modified for interconnection of additional DG
- Address proposals for cost allocation issues that determine who bears responsibility for system upgrade costs

---

## 3.1 PROPOSED MITIGATION STRATEGIES AND ACTION PLANS

Load and DG projections are based on preliminary, market-driven forecasts for DG uptake across Oahu, Maui, and Hawai`i. These forecasts, described in **Appendix B**, include NEM, FIT, and SIA projects through 2016 and assume a reformed tariff structure ("DG 2.0") beginning in 2017.

Larger (e.g., FIT) projects usually require interconnection requirement studies that identify mitigation measures, such as fast-trip inverters, local relay and fast-trip breakers;

### 3. Distributed Circuit Improvement Implementation Plan (DCIIP)

#### 3.1 Proposed Mitigation Strategies and Action Plans

high-speed recorders; and provisions for future direct transfer trip and surge arresters. Typically, NEM customers individually do not warrant this level of study and specific mitigations; therefore, the Companies developed a base-case cost model to estimate the cumulative impact of projected DG customers on circuits.

##### 3.1.1 Interconnection Policies

As more testing is completed and additional system monitoring provides further insight into the impacts of increasing levels of DG penetration, modifications to Rule 14H are expected to reflect the changing understanding and development of new solutions. In addition, Rule 14H will evolve over time, because the system is dynamic, and more technologies will be put into place on the system.

In the short term and going forward, policies will be proposed that allow the Companies to enable greater interconnection of DG, while providing safe and reliable electric service to all customers. Customer-level strategies, such as energy storage, use of advanced inverter functionalities, and various levels of active power control, are expected. The many existing policies related to DG must be combined and consistent across the Companies. This effort is addressed in Section 5 of this DGIP and in the Integrated Interconnection Queue (IIQ).

##### 3.1.2 System-Level Recommendations

System constraints are a major concern, because DG penetration has reached a level that creates system reliability risks and thus, are more urgent than circuit issues. In addition to system resource acquisitions, mitigation measures include implementing disturbance ride-through capabilities and active power control to manage contingency or emergency conditions. Modification of the under-frequency load-shed scheme is also required. These technologies as well as storage and demand response, including proposed modifications to Rule 14H, are discussed in Section 4.

The PSIPs will incorporate system reliability and system-level mitigations. Because of the aggregated small and large impacts of DG identified in the system-level studies, the Companies recommend the PV Subgroup members be allowed to continue their collaborative efforts to address these impacts and issues and submit further stipulations that they are able to achieve after presentation and discussion of the system-level studies. This is consistent with the Second Stipulation Regarding Work Products Submitted as a Part of the January 18, 2013, Final Report of the PV Subgroup for the Reliability Standards Working Group, filed in Docket No. 2011-0206 on June 12, 2014.

### 3.1.3 Circuit-Level Recommendations

In evaluating each company's existing and projected load and DG, distribution-level improvements were determined for the short-term (2014–2016), mid-term (2017–2020), and long-term (2021–2030) planning horizons. Load and DG projections are consistent with the Companies' DG market forecast.

The circuit and substation capacity analysis and base case cost model compare existing and projected loads and DG penetration and identify constraints on circuits and substation transformers. While the improvements were identified to enable the system to handle larger amounts of DG, benefits from the upgrades also include greater system flexibility, transparency in system loading and customer information, strength in capacity and voltage, and potential customer satisfaction.

The cost and schedule of component replacements to alleviate the above-mentioned constraints are summarized as follows (see detailed project list in **Attachment F**). Cost tables include 10% risk adjustment on constant 2014 dollars and present budgetary numbers that include materials, labor, and overhead.

- LTC/Substation Regulator Controller Replacement Program (see **Table 3-1**):
- Transformers are flagged when existing or approaching reverse power flow is anticipated, and required LTC controller or substation regulator upgrades are identified and scheduled. LTC controller upgrades may not be required in each case, but are included in this high-level estimate. For Hawaiian Electric, existing LTC controllers capable of reverse flow were excluded from the upgrades. Some Maui Electric costs are for substation regulator replacements.
- In addition to reverse flow, there are other factors, which are not accounted for in this analysis, for determining when LTC or substation regulator upgrades will be required. Actual conditions for circuit topology, voltage levels, and age are examples of other determining factors.
- Cost to upgrade each LTC is \$10,000; regulator costs were specified at \$30,000 or \$40,000.
- These upgrades are already in progress.



### 3. Distributed Circuit Improvement Implementation Plan (DCIIP)

#### 3.1 Proposed Mitigation Strategies and Action Plans

Location	Quantity	Upgrade Description	Cost		
			Short-term (2014-2016)	Mid-term (2017-2020)	Long-term (2021-2030)
Hawaiian Electric	70	Replace	\$352k	\$154k	\$264k
Maui Electric	31	Replace	\$318k	\$33k	\$147k
Hawai`i Electric Light	34	Replace	\$242k	\$77k	\$55k

\*calculations in current year dollars

Table 3-1. LTC Controller Upgrades

- Circuit Upgrade Program (see **Table 3-2**):
- Circuits with reverse power flow were flagged when the 50% thermal limit of the circuit backbone capacity was approached or if previous studies identified conductor or voltage constraints. Reconductoring of 12 kV circuits are identified and scheduled. Cost estimates for 12 kV primary backbone reconductoring are \$1,100,000 per mile for overhead and \$4,300,000 per mile for underground.
- For 4 kV circuits, conversions are assumed to be included in the 10-year 4 kV Conversion Plan and are not included in these estimates.
- Distribution transformers were upgraded when 100% capacity was exceeded based on a linear equation for a relationship between percentage of transformers to be replaced and percentage of circuit GDML. A distribution transformer upgrade without pole and secondary is estimated at \$10,000 per installation for Hawaiian Electric and for Maui Electric and \$5,000 for Hawai`i Electric Light.
- Fifteen percent of distribution transformer replacements include pole replacement and secondary upgrades. Cost estimates for a distribution transformer upgrade with pole and secondary are \$25,000 per installation for Hawaiian Electric and Maui Electric and \$13,000 per installation for Hawai`i Electric Light.
- Voltage regulators were identified for each circuit and assumed to require controller upgrades because of reverse flow at the circuit level. Costs for voltage regulator upgrades are estimated at \$10,000 per upgrade, unless otherwise specified.

3. Distributed Circuit Improvement Implementation Plan (DCIIP)  
3.1 Proposed Mitigation Strategies and Action Plans

Location	Quantity	Upgrade Description	Cost		
			Short-term (2014- 2016)	Mid-term (2017- 2020)	Long-term (2021- 2030)
<i>Hawaiian Electric</i>					
	10	Voltage regulator	\$77k	\$22k	\$11k
	16.55	Primary reconductor	0	0	\$75,589k
	1223	Distribution transformers	\$3,081k	\$3,756k	\$6,612k
	183	Pole and secondary	\$693k	\$845k	\$1,488k
<b>Total</b>			<b>\$3,851k</b>	<b>\$4,623k</b>	<b>\$83,700k</b>
<i>Maui Electric</i>					
	6	Voltage regulator	\$44k	\$11k	\$11k
	0	Primary reconductor	0	0	0
	80	Distribution transformers	\$540k	\$205k	\$130k
	12	Pole and secondary	\$122k	\$46k	\$29k
<b>Total</b>			<b>\$706k</b>	<b>\$262k</b>	<b>\$170k</b>
<i>Hawai'i Electric Light</i>					
	12	Voltage regulator	\$66k	\$22k	\$44k
	0	Primary reconductor	0	0	0
	235	Distribution transformers	\$841k	\$425k	\$27k
	35	Pole and secondary	\$202k	\$102k	\$6k
<b>Total</b>			<b>\$1,109k</b>	<b>\$549k</b>	<b>\$77k</b>

\*calculations in current year dollars

Table 3-2. Circuit Upgrade Program

- Substation Transformer Program (see **Table 3-3**):
- Transformers with reverse flow were flagged when the 50% thermal limit of the nameplate capacity was approached.
- Costs for adding a substation transformer are \$2,250,000 per project.
- Maui Electric provided its own estimates for the two known substation transformer replacement projects, as presented in the following table.

### 3. Distributed Circuit Improvement Implementation Plan (DCIIP)

#### 3.1 Proposed Mitigation Strategies and Action Plans

Transformer Location	Quantity	Upgrade Description	Cost		
			Short-term (by 2016)	Mid-term (by 2020)	Long-term (by 2030)
Hawaiian Electric	21	Add transformers to split load	\$0	\$2,475k	\$49,500k
Maui Electric	2		\$66k	\$0	\$250k
Hawai'i Electric Light	1		\$2,475k	\$0	\$0

\*calculations in current year dollars

Table 3-3. Substation Transformer Upgrades

- Grounding Transformer Program (see **Table 3-4**):
- Grounding transformers were added when DG exceeds 33% GDML of 3-phase DG at the circuit level for certain configurations of preselected circuits for Maui Electric and Hawai'i Electric Light. (To estimate the cost impact since not all 3-phase circuits require upgrade at 33%, grounding transformers were flagged to be added when DG exceeds 66% on pre-selected circuits.) They were added to the 46 kV system, when DG exceeds 50% GDML at the 46 kV level for Hawaiian Electric.
- Cost for each grounding transformer is estimated at \$947,000 for Hawaiian Electric 46 kV and \$60,000 for Maui Electric and Hawai'i Electric Light distribution circuits.
- These estimates are assumptions for the base case cost model, but each Company will have the discretion to require customer upgrades or upgrade utility infrastructure.

Location	Quantity	Upgrade Description	Cost		
			Short-Term (2014- 2016)	Mid-Term (2017- 2020)	Long-Term (2021- 2030)
Hawaiian Electric	36	Add grounding transformer on 46 kV lines	\$31,252k	\$3,125k	\$3,125k
Maui Electric	67	Add grounding transformer at circuit level	\$1,518k	\$2,244k	\$660k
Hawai'i Electric Light	16	Add grounding transformer at circuit level	\$264k	\$726k	\$132k

\*calculations in current year dollars

Table 3-4. Grounding Transformer Upgrades

In addition, costs for transmission and sub-transmission upgrades, system monitoring, and other protection items are currently under consideration and may be included. System-level mitigations will be provided in the PSIPs.

**3. Distributed Circuit Improvement Implementation Plan (DCIIP)**  
3.1 Proposed Mitigation Strategies and Action Plans

The base-case cost model assumptions and schedule of component replacements to alleviate constraints based on the Companies' DG forecast are summarized in **Table 3-5**. Each company will have the discretion to require customer upgrades or upgrade utility infrastructure.

Item	Violation Trigger	Unit Cost	2016	2020	2030	Total
Installed DG (MW)	--	--	547	677	902	
Regulator	Feeder Reverse Flow	\$10,000	\$187,000	\$55,000	\$66,000	\$308,000
LTC	Substation Transformer Reverse Flow	\$10,000	\$912,000	\$264,000	\$466,000	\$1,642,000
Reconductoring	Exceed 50% Backbone Conductor/Cable Capacity	\$1,100,000 OH/ \$4,300,000 UG per mile	\$-	\$-	\$75,588,700	\$75,588,700
Substation Transformer and Switchgear	Exceed 50% Capacity	Varies	\$2,541,000	\$2,475,000	\$49,750,000	\$54,766,000
Distribution Transformer	Exceed 100% Loading, % GDML Linear Relationship to % Transformers Upgraded	Varies (1)	\$4,462,164	\$4,386,633	\$6,768,738	\$15,617,535
Poles and Secondary	Assumed 15% of Distribution Transformer Replacements Include Pole Replacement and Secondary Upgrades	Varies (1)	\$1,016,605	\$993,371	\$1,523,365	\$3,533,342
Grounding Transformers	Exceed 33% GDML (66% in model) for Selected Feeder for Maui Electric and Hawai'i Electric Light; exceed 50% GDML for 46 kV Lines for Hawaiian Electric	\$60,000 for Maui Electric and Hawai'i Electric Light; \$947,000 for Hawaiian Electric	\$33,033,000	\$6,095,100	\$3,917,100	\$43,045,200
<b>Total</b>	<b>--</b>	<b>--</b>	<b>\$42,151,769</b>	<b>\$14,269,104</b>	<b>\$138,079,904</b>	<b>\$194,500,777</b>
Notes: (1)		1-ph xfmr only	Pole and secondary			
	Hawaiian Electric	\$10,000	\$15,000			
	Maui Electric	\$10,000	\$15,000			
	Hawai'i Electric Light	\$5,000	\$8,000			

\*calculations in current year dollars

**Table 3-5. Violation Trigger and Base Case Cost Model Summarization, by Term**

**Table 3-6** summarizes the estimated costs of recommended system replacements for the Companies.

### 3. Distributed Circuit Improvement Implementation Plan (DCIIP)

#### 3.1 Proposed Mitigation Strategies and Action Plans

Location	Cost 2014-2016	Cost 2017-2020	Cost 2021-2030
Hawaiian Electric	\$35,454k	\$10,377k	\$136,589k
Maui Electric	\$2,608k	\$2,539k	\$1,227k
Maui	\$2,550k	\$2,261k	\$1,219k
Molokai	\$58k	\$279k	\$8k
Lanai	\$0	\$0	\$0
Hawai'i Electric Light	\$4,090k	\$1,352k	\$264k
<b>Total</b>	<b>\$42,152k</b>	<b>\$14,269k</b>	<b>\$138,080k</b>

\*calculations in current year dollars

Table 3-6. Cost Summarization, by Term

**Figure 3-1** summarizes the cumulative estimated costs of recommended system replacements and projected installed DG in the short, medium, and long term. **Figures 3-2** through **3-4** show estimated annual cumulative cost of upgrade for each Company.

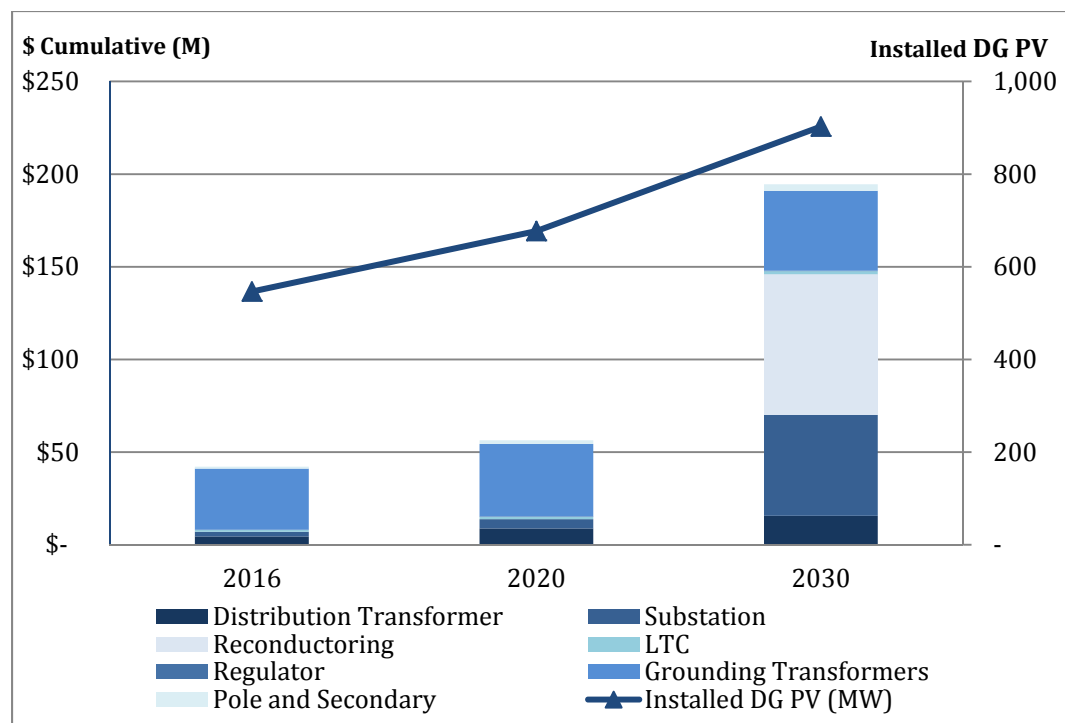

Figure 3-1. Cumulative Estimated Costs of Recommended System Replacements

3. Distributed Circuit Improvement Implementation Plan (DCIIP)  
 3.1 Proposed Mitigation Strategies and Action Plans

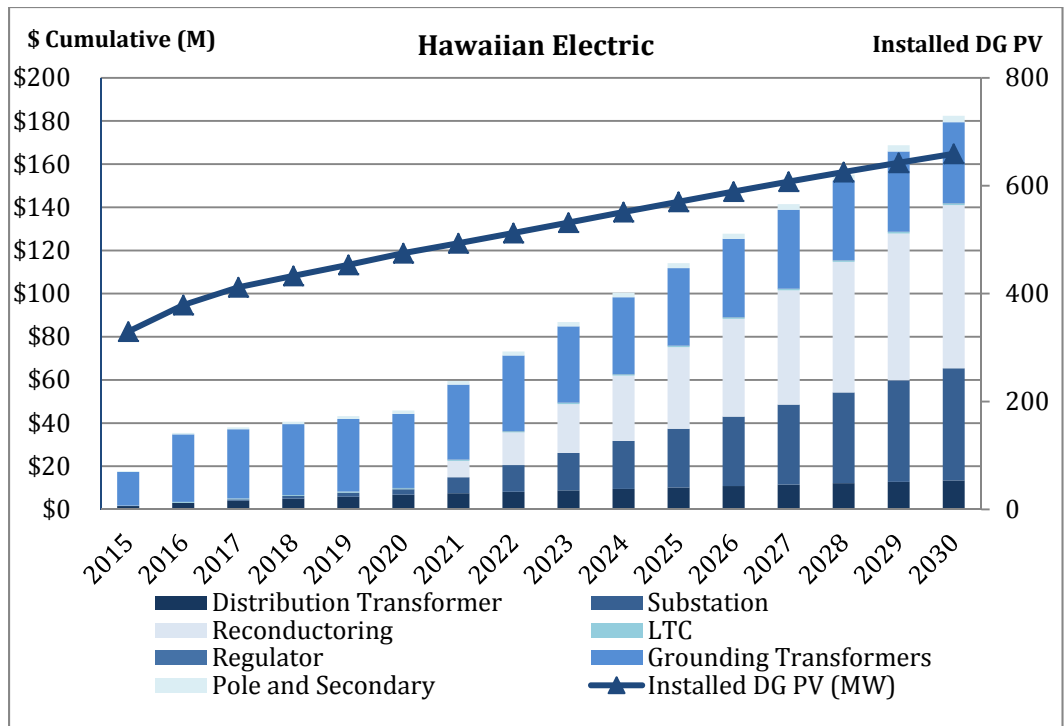

Figure 3-2. Hawaiian Electric Cumulative Estimated Costs of Recommended System Replacements

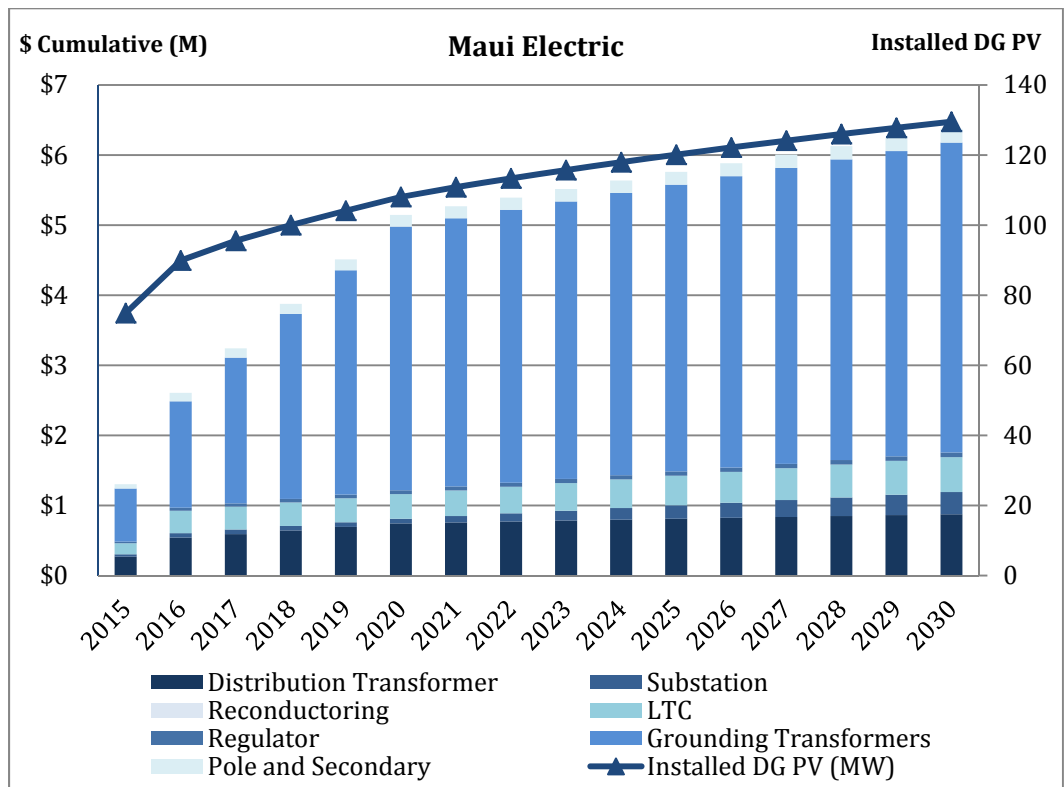

Figure 3-3. Maui Electric Cumulative Estimated Costs of Recommended System Replacements

### 3. Distributed Circuit Improvement Implementation Plan (DCIIP)

#### 3.1 Proposed Mitigation Strategies and Action Plans

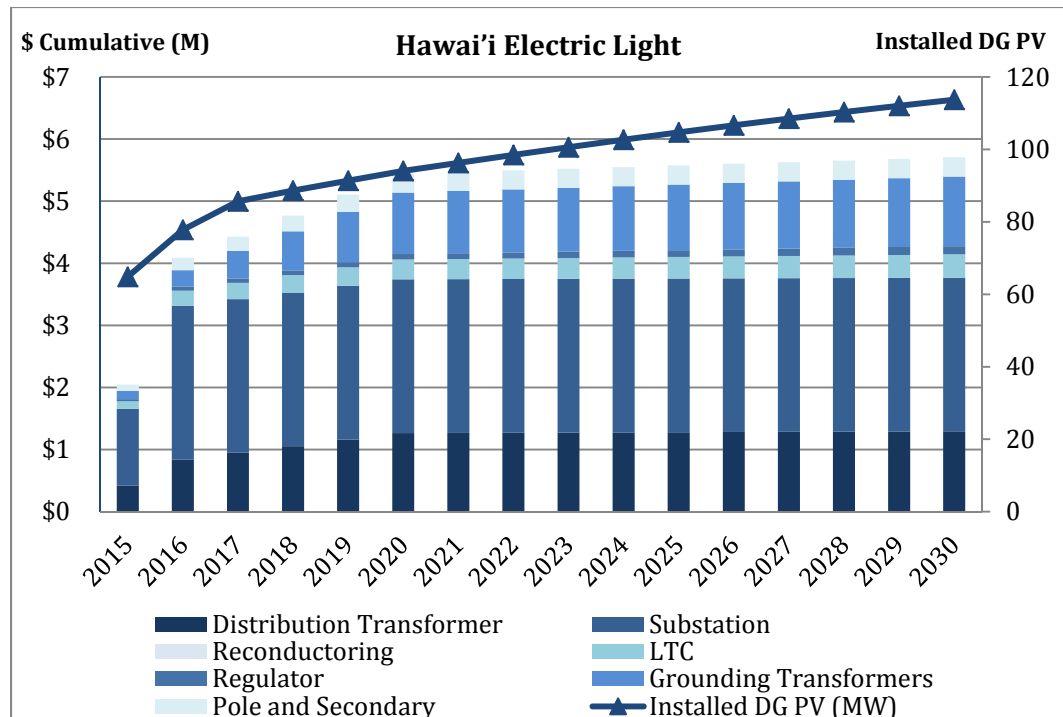

Figure 3-4. Hawai'i Electric Light Cumulative Estimated Costs of Recommended System Replacements

#### 3.1.4 Company Budget Overlaps

Table 3-7 summarizes the status of improvements already reflected in existing Company budgets. There are two projects with significant budget overlaps: LTC Controller Replacement and the reconductoring of the primary circuits. Hawaiian Electric has ongoing programs that meet DGIP requirements in the Company budget that includes these projects, and Maui Electric has some of the specified LTC controller or substation recloser upgrades included in existing budgets. The remaining projects have no overlaps with the Company budgets, except for some Hawai'i Electric Light projects that will be funded by fees collected from existing DG customer. Also 4 kV circuit upgrades are not included in the DGIP budget, because the Companies expect to complete their 4 kV conversion program, as planned.

**3. Distributed Circuit Improvement Implementation Plan (DCIIP)**  
 3.1 Proposed Mitigation Strategies and Action Plans

Projects	DGIP Budget		Status	Comments
	Quantity	Cost		
Regulators	28	\$308,000	No Overlap	Not included in the Company budget.
LTC Controller Replacements	135	\$1,642,000	Partial Overlap	Consistent with the Company budget, except for timing. Partial overlap for Maui Electric; no overlap for Hawai'i Electric Light.
Reconductoring	16.55	\$75,588,700	Overlap	Consistent with the Company budget, except for timing.
Substation Transformers and Switchgear	24	\$54,766,000	No Overlap	Planned for different purposes. Substation Transformer replacement projects in the DGIP are proposed due to solar penetration, while the ones in asset management result from replacement of aging equipment. New capacity expansion is part of customer projects or engineering projects for increased load/reliability. Hawai'i Electric Light has collected funds from DG customers for DG-driven substation upgrades.
Distribution Transformers	1,537	\$19,150,877	Partial Overlap	Planned for different purposes. Distribution Transformer replacement projects in the DGIP are proposed due to solar penetration, while the ones in the Company budget are due to replacement of aging equipment. * Includes pole and secondary replacements. Hawai'i Electric Light has collected funds from DG customers for DG-driven transformer upgrades.
Grounding Transformers	119	\$43,045,200	Partial Overlap	Not included in the Company budget. Hawai'i Electric Light has collected funds from DG customers for DG-driven substation upgrades.
4 kV Conversion	N/A	N/A	No Overlap	Not included in the DGIP budget because the Company will complete these projects, as planned.

\*calculations in current year dollars

Table 3-7. Status of Budget DGIP and Company Budget Projects

### 3.1.5 Prioritization of Proposed Mitigation Actions

The figures in the base case cost model are high-level cost estimates for potential capacity upgrades that may be required based on the market potential for DG. The prioritized list



### 3. Distributed Circuit Improvement Implementation Plan (DCIIP)

#### 3.1 Proposed Mitigation Strategies and Action Plans

of expected mitigations for circuit-level improvements based on the base case cost model is shown in **Table 3-8**.

Improvements	Hawaiian Electric			Maui Electric			Hawai'i Electric Light		
	2016	2020	2030	2016	2020	2030	2016	2020	2030
LTC Controller Upgrades (qty)	32	14	24	19	3	9	22	7	5
Voltage Regulator Controller Upgrades (qty)	7	2	1	4	1	1	6	2	4
Primary Conductor Upgrades (backbone and laterals) (miles)	0	0	16.6	0	0	0	0	0	0
Substation Transformer Upgrades (qty)	0	1	20	1	0	1	1	0	0
Distribution Transformer Upgrades (qty)	280	341	601	49	19	12	153	77	5
Pole and Secondary Replacements (qty)	42	51	90	7	3	2	23	12	1
Grounding Transformers (qty)	30	3	3	23	34	10	4	10	2

**Table 3-8. Circuit-Level Improvements**

Some of the upgrades identified may take 1–3 years to complete (reconductoring, substation transformers, grounding transformers). The circuit analysis work being conducted establishes the framework for studying mitigation measures, as well as designing and constructing these circuit upgrades.

Simulation-based analysis with new models and validation, using field-measured information consistent with a proactive approach, will be used to evaluate the most cost-effective measures, determine which upgrades to deploy, and determine under what conditions – steady-state or transient – responses should be implemented. The current circuit analysis lays the framework for studying mitigation measures. Before the maximum thresholds for DG penetrations are reached, these studies can be used to assess expansion needs and evaluate broader mitigation measures, as the grid modernizes and changes. New technologies that are appropriately modeled can then be simulated for their effectiveness without sacrificing the reliability and performance of the existing system.

The types and magnitude of mitigation measures depend on the circuit configuration, customer mix, and DG penetration, as shown by the studies. These potential alternate mitigation actions include:

- Modify existing inverter controls for extended ride-through, fast-trip functionality, and, potentially, power factor control
- Specify non-export
- Add customer-level grounding banks
- Require DTT
- Upgrade protection and voltage control equipment
- Upgrade customer transformer and secondary
- Install line capacitors or line regulators to level the distribution voltage across the distribution circuit and the secondary service drops, and adjust LTC settings to maintain a uniform voltage across the circuit by reducing the variability of voltage
- Support deployment of customer-side energy storage technologies and a non-export class of systems to reduce the impact of fluctuations in generation from solar variability, a wider range of voltage issues, and equipment overloads
- Transition to smarter and more advanced inverters, including two-way communications, utility active power control, configuration verification, and reactive power options, at a minimum, to provide the utility with increased reliability, security controls, and options
- Implement substation, grid, and/or other forms of battery storage when economically viable to provide additional generation when needed and to control voltage issues and equipment overloads
- Implement demand response options that turn on or off residential or commercial equipment during critical periods to control load, instead of solar variability, which is easier to implement; take advantage of smart-grid communications; and implement more advanced forms of demand response, including real-time balancing of load and DG

Undertake voltage conversion projects to address transformer and circuit overloads and voltage issues.

**Table 3-9** shows a partial list of potential mitigation measures that could be implemented under steady-state and first-contingency conditions during the short (S), medium (M), and long (L) terms. This list will likely be expanded to capture other potential mitigation measures as similar transient and dynamic studies are performed. A more complete list is included in Attachment H.

### 3. Distributed Circuit Improvement Implementation Plan (DCIIP)

#### 3.1 Proposed Mitigation Strategies and Action Plans

The column headings in **Table 3.9** (System, Substation and Circuit, and Customer Level Impacts) are fully defined in Section 1 of this DGIP. The rows in bold type present a major solution.

Mitigation Measure	Applicable DG Effect						
	System		Substation and Circuit			Customer	
	<i>Transient</i>	<i>Steady State</i>	<i>Transient</i>	<i>Steady State</i>		<i>Transient</i>	<i>Steady State</i>
	<i>System Reliability</i>	<i>Excess Energy</i>	<i>TrOV</i>	<i>Voltage Issues</i>	<i>Equipment Overload</i>	<i>TrOV</i>	<i>Equipment Overload</i>
<b>Change Existing Inverters (Ride-through and trip settings)</b>	S			S		S	
<b>Advanced Inverter Functionalities</b>	M		S			S / M	S / M
<b>Active Power Control/Curtailment</b>	M	M / L	S / M	M	M / L	S / M	S / M
<b>Energy Storage – Utility side</b>	M	M		M	M		
<b>Energy Storage – Customer-side</b>		S		S	S	S	S
Non-Export (Size Limits)						S	S
Grounding Bank			S				
Circuit Direct Transfer Trip			S				
Customer Direct Transfer Switch			S			S	
Dynamic Load-Shed Scheme	S						
Substation Short Switch			M			M	
Customer Surge Arresters			S			M	
Voltage Control				S			
Equipment Upgrades (Primary and secondary conductor upgrades; primary voltage upgrade to 12 kV)						S	S
Demand Response (Turning Off/On Equipment)		M		M	M		

Table 3–9. List of Potential Mitigation Measures

#### 3.1.6 Distribution Circuit Improvement Implementation Plan—Cost-Benefit Model

The base case cost model developed for the Distribution Circuit Improvement Implementation Plan assumes investment, as needed, to accommodate market-driven

### 3. Distributed Circuit Improvement Implementation Plan (DCIIP)

#### 3.1 Proposed Mitigation Strategies and Action Plans

DG, with no external limits on DG growth or on circuit capacity. This approach does not include a cost-benefit analysis of the proposed mitigation measures. Several mitigation measures identified in **Table ES-5** may be more cost-effective than circuit or substation improvements identified in the base case cost model.

Consequently, the Companies developed an alternative cost model that would enable high levels of DG growth, while also assuming the Companies have some ability to shape and control the nature and distribution of this new DG. This approach identifies cost levers for applying particular technologies and establishes an estimated range of investment.

For instance, distribution transformer upgrades and/or steady state over-voltage may be mitigated by limiting PV system size to historical load or utilizing inverter volt-watt functions or fixed power factor adjustment. The Companies will continue to study these options in the near term to determine if they are viable options to equipment upgrades. Implementing these smart inverter functions or a system size limit policy could potentially negate the estimated \$19.5 million cost of distribution transformer upgrades.

Circuit level issues requiring grounding transformers and TrOV circuit limits may be mitigated with fast trip inverters, DTT, short switches, or surge arresters. Circuit-level storage can address capacity issues. These potential solutions will require additional research and development, but may prove to be viable options to the base case cost model.

A cost-effective means for reducing circuit improvement costs is to limit the DG capacity. To allow a greater number of customers to install DG on circuits with limited capacity, measures could be adopted that reduce the contribution of each system, such as limits on the DG installed, limiting the size of DG systems and/or requiring the use of non-export systems on circuits with high DG penetration. The cost-benefit approach balances investment costs against the benefits and expense of installing significantly larger amounts of DG. Therefore, it would improve circuits where those investments may lead to a large increase in DG penetration, but it would constrain expenditures on circuits where large investments might lead only to incremental increases in DG. This approach would be evaluated through a comprehensive and transparent process involving impacted stakeholders, the Department of Commerce and Consumer Affairs, Division of Consumer Advocacy (Consumer Advocate), and the Commission.

The base case cost model was developed by analyzing projected load and DG penetration to determine potential upgrades based on reasonable planning assumptions of circuit limitations and requirements. As grid modernization continues along with an advanced metering infrastructure (AMI), significantly more data can be collected on circuit performance. Advanced analytics services may enable circuits to perform more closely to their design limits, which would allow for more growth with less investment. Combining

### 3. Distributed Circuit Improvement Implementation Plan (DCIIP)

#### 3.1 Proposed Mitigation Strategies and Action Plans

improved data collection with advanced inverter features also would create additional capabilities, including reactive power compensation (i.e., better voltage control).

The advanced controls of a modern grid may help manage DG energy, and allow demand response and customer load incentive programs such as time-of-use rates and preferential EV charging programs. A modern system that can control load and generation (“up/down” control) may make it possible to defer, or avoid altogether, some circuit improvements. When combined with circuit monitoring and better data, the costs of improvements over the long term may be lower than predicted by a base case cost model.

The Distributed Generation Interconnection Capacity Analysis (DGICA) identifies that circuit upgrades are required to accommodate the high levels of reverse power flow during peak DG generation. The DGIP estimates the cost of these upgrades at \$195 million, assuming the DG forecast of 902 MW for the Companies.

At the circuit level, non-export DG does not contribute as heavily to reverse power flows and, therefore, could reduce the need for associated upgrades when compared to unmitigated exporting PV. This could allow more customers to install DG systems on circuits with a finite capacity for additional DG systems and avoid incurring costs associated with upgrades. However, non-export customers will reduce demand, which will result in exacerbating impacts of existing exporting PV; this ultimately may require some level of system modifications. Compared with the DGIP base case cost model, four levels of non-export were analyzed – 100%, 75%, 50%, and 25% of the proposed residential DG (NEM and DG 2.0) beginning in 2014. **Table 3-10** compares projected 2030 capital costs for each type of upgrade at these non-export levels. The table shows significant reduction in reconductoring, substation upgrades, and distribution transformer upgrades.

Item	Base-Case Full Export	Non-Export 25%	Non-Export 50%	Non-Export 75%	Non-Export 100%
Non-Exported DG (MW)	0	73	146	219	292
Regulator	\$308,000	\$297,000	\$242,000	\$220,000	\$198,000
LTC	\$1,642,000	\$1,546,000	\$1,447,000	\$1,304,000	\$1,172,000
Reconductoring	\$75,588,700	\$75,588,700	\$58,549,150	\$21,899,900	\$-
Substation	\$54,766,000	\$37,375,000	\$24,750,000	\$17,325,000	\$4,950,000
Distribution Transformers Including Pole and Secondary Replacements	\$19,150,877	\$16,142,757	\$13,274,162	\$10,578,792	\$9,674,502
Grounding Transformers	\$43,045,200	\$45,972,300	\$42,517,200	\$41,857,200	\$41,527,200
<b>TOTAL</b>	<b>\$194,500,777</b>	<b>\$176,921,757</b>	<b>\$140,779,512</b>	<b>\$93,184,892</b>	<b>\$57,521,702</b>

Table 3-10. Projected 2030 Cumulative Capital Cost Comparison DGIP versus Non-Export Options

Table 3-11 and Figure 3-5 compare the cumulative costs for the short, medium, and long term. The extremes and some benchmarks in between were analyzed to illustrate how circuit upgrade costs can decrease with increased levels of non-export systems. This solution is more applicable in outer years, as thermal limits and additional upgrade costs are incurred; subsequently, this is not as likely to reduce costs in the short term, except on individual, highly constrained circuits.

Export Options	Non-Export DG	2016	2020	2030
Non-export 100%		\$36,298,903	\$41,964,098	\$57,521,702
Non-export 75%		\$36,853,302	\$44,715,841	\$93,184,892
Non-export 50%		\$39,094,246	\$47,043,480	\$140,779,512
Non-export 25%		\$41,169,277	\$54,007,403	\$176,921,757
Base case, full export		\$42,151,769	\$56,420,873	\$194,500,777

\*calculations in current year dollars

Table 3-11. Cumulative Cost Comparison DGIP Versus Non-Export Option

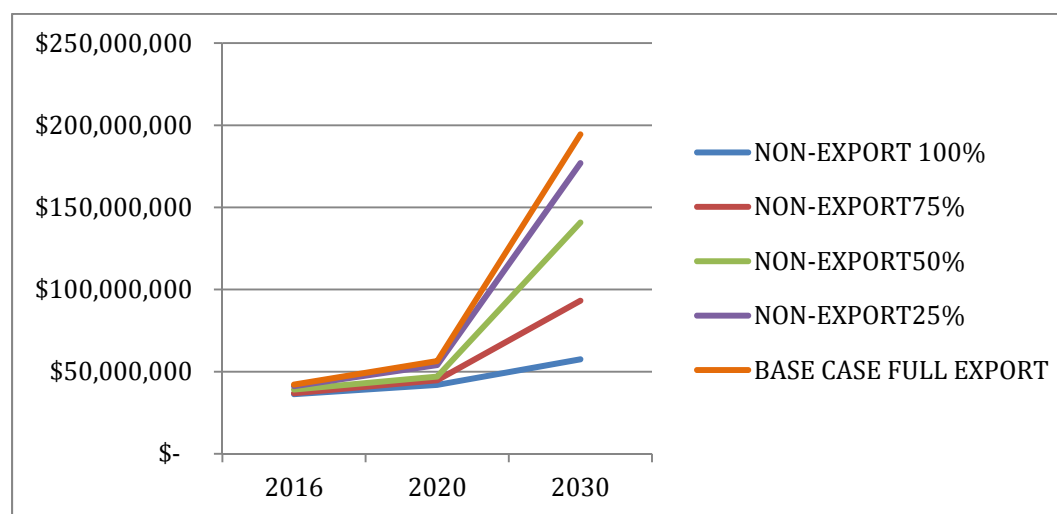

Figure 3-5. Non-Export Cumulative Cost Options

Modeling non-export DG in the generation portfolio at 100% (348 MW) shows that distribution system cost upgrades through 2030 can potentially be reduced by \$137 million. On circuits with high penetration levels, higher levels of renewable integration are possible without incurring circuit upgrade costs when non-export DG is used before reaching distribution system thermal limitations, allowing more customers to have access to options to self-generate and reduce electricity costs.

### 3. Distributed Circuit Improvement Implementation Plan (DCIIP)

#### 3.1 Proposed Mitigation Strategies and Action Plans

#### 3.1.7 Modifications to Distribution System Design Criteria and Operational Practices

In addition to specific improvement mitigations and upgrades, modifications to distribution system planning and design criteria and operations practices were developed and considered to harden the distribution system to accommodate high penetrations of DG.

Distribution System Design Considerations (new and existing circuits):

- System Impedance
  - Low impedance circuits are less prone to voltage regulation, flicker, and protection issues with the presence of high DG.
  - Align DG planning needs with Company budget programs, if possible, when replacing main circuit backbone conductors. On high-penetration circuits, increase conductor size to strengthen the circuit (lower impedance).
  - Continue to design shorter-length circuits. Avoid long circuit designs where feasible.
- Distribution Transformers
  - Upgrade distribution transformers and secondary conductors to accommodate future customer DG.
- Voltage Regulation Equipment
  - Continue to outfit distribution substation transformers and voltage regulators with the latest LTC controller technology with reverse flow capabilities
  - Avoid circuit designs that require line voltage regulators where feasible
  - Optimize LTC reverse flow settings on circuits with large amounts of reverse flow
- Circuit-Level TrOV Mitigations
  - Continue to evaluate emerging circuit-level equipment to mitigate ground fault and load rejection over-voltage
  - Surge arresters on the distribution circuit can possibly reduce high over-voltages greater than 160% of nominal
  - Evaluate cost and feasibility of implementing fast acting load switching device to absorb transient over-voltages in islanded conditions

#### Operational Practices:

- Voltage Regulation Bands
  - As part of the smart grid efforts to implement volt/VAR optimization (VVO) to improve efficiency, distribution circuits may need to operate in a tighter voltage band than +/-5% of nominal voltage. Voltage regulator settings will need to be

### 3. Distributed Circuit Improvement Implementation Plan (DCIIP)

#### 3.1 Proposed Mitigation Strategies and Action Plans

analyzed and optimized to meet the goals of VVO. High penetrations of DG will affect VVO implementation.

- Distribution Circuit Flexibility
  - Maintain the flexibility of distribution circuits by limiting the reverse flow due to DG to 50% of the substation transformer or conductor thermal ratings.
  - Flexibility will allow circuits to be reconfigured or redesigned if load growth (particularly during the evening peak) necessitates circuit capacity relief.
  - During daylight hours, system operators must have the flexibility to restore customers in the event of an unplanned or planned outage. Allowing reverse flow of PV up to the maximum capacity limits the ability for circuits to back up other circuits experiencing outages. This is particularly problematic without control of the distributed PV resources.
- Islanding Protection
  - Lengthen reclosing time of circuit breakers and reclosers to at least a 5-second delay to coordinate with inverter anti-islanding protection. This will minimize the risk of an unintended island forming, but will lengthen customer outages. Inverters are required by IEEE 1547 to de-energize within 2 seconds on loss of utility service.
- Voltage Regulator Tap Operations
  - Use SCADA to monitor tap operations and assess maintenance impacts.
  - If LTC life cycles are significantly affected, optimize LTC settings to reduce the amount of tap movements per year, where feasible. May require additional circuit mitigation measures to manage voltages without LTC changes.
- SCADA at the Majority of Distribution Substations
  - Monitor voltage and power flow of distribution circuits to give system operators real-time visibility and system planners historical visibility of the circuit conditions due to DG. Data regarding circuit demand levels supports informed operator decisions, enables operational mitigation measures such as dynamic under-frequency load-shedding, and more efficient operation and planning, as well as better informed DG policies.
  - Record information on LTC tap movements.
  - Capture actual field events to evaluate the impacts of DG.

SCADA reduces the risk of losing or missing event data captures stored locally on monitors. SCADA will also reduce cost and time to send technicians out to the field to retrieve data.



### 3. Distributed Circuit Improvement Implementation Plan (DCIIP)

#### 3.1 Proposed Mitigation Strategies and Action Plans

#### 3.1.8 Proactive Approach and Process Improvement

A new, proactive modeling method for assessing the high growth and penetration of DG on distribution and transmission systems has been developed as part of a collaborative effort between Hawaiian Electric Companies, the Sacramento Municipal Utility District (SMUD), and Det Norske Veritas (DNV) with funding from the California Public Utilities Commission, California Solar Initiative (CSI) initiative. Using this methodology and representative circuit- and system-level studies and the screening tool developed for this report, the Companies have taken steps to proactively study and address the potential circuit constraints within the current infrastructure. With more aggressive infrastructure modernization, monitoring, and data analytics with new DG management tools, significant amounts of additional DG can be added to the various island grids.

The Proactive Approach is not just a single circuit study or IRS or even a model, but an improvement to the practice of T&D planning that incorporates coordination of procurement, alignment of DG resources, and use of validated field data to actively plan and assess impacts on the system. The current process looks at distribution-level solutions, but the Companies recommend a more interconnected approach that has feedback. The approach uses models to simulate scenarios of growth based on analysis of trends using REDatabase and complements the modernization efforts, bringing in new customer load data with system impacts. The Proactive Approach drives planning that keeps pace with changing technology and modernization needs.

The T&D efforts will improve with enhanced tools, easily accessible data, and new data needs to enable active management of variable renewable resources. The Proactive Approach is not about the impact of high penetrations of DG on any single circuit, but about the system. Proactive planning will include the following strategies:

- Maintaining up-to-date distribution system computer models and performing similar analysis will identify additional distribution system issues and upgrades, such as voltage and capacity issues, in a proactive and timely manner.
- Mitigations to the technical issues and system constraints will be revisited each year to adjust criteria and practices as appropriate. Proactive analysis of circuit models with existing and potential DG also will be updated annually.

As is discussed in the Integrated Interconnection Queuing plan, the Proactive Approach with T&D planning will be integrated into the queuing process for DG applications. As shown in **Figure 3-6**, applications for DG interconnection will be tracked against circuit and system constraints. When an application becomes delayed due to constraints, T&D planning will have identified needed capital to remove constraints on circuits. If a circuit needs upgrades, the applicant can be notified. If an upgrade is not planned, this information can inform future capital planning efforts.

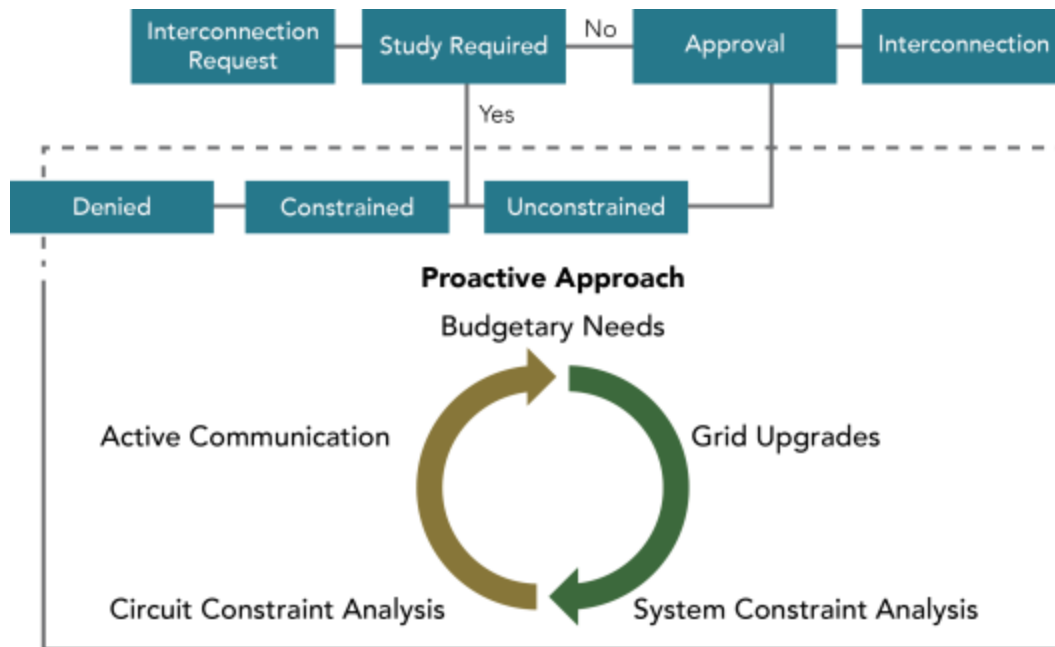

Figure 3-6. Integrating Queuing with Proactive Planning

### 3.2 COST ALLOCATION IMPLICATIONS

The LTC controller replacements, circuit upgrade programs, substation transformer upgrades, and other improvements are expected to relieve constraints on reverse power flow and to mitigate the effects of high penetrations of DG on circuits and substations. These costs are expected to be approximately \$42 million in the near term (by 2016), an additional \$14 million by 2020, and another \$138 million by 2030. Section 4 discusses technology, active power control, or non-export options that may postpone or alleviate the need for these upgrades. The cost and benefit of those recommendations will be evaluated to determine the appropriate implementation plan.

There are many solutions identified above, but some are more costly than others. In general, the most economical solutions will be implemented to enable DG growth, so long as they also maintain system reliability and safety. The appropriate method for allocating and recovering these costs and other DG-related costs to minimize cross-subsidies is under consideration and addressed in Section 5.

**3. Distributed Circuit Improvement Implementation Plan (DCIIP)**  
3.2 Cost Allocation Implications

This Page Intentionally Left Blank

## 4. Advanced DER Technology Utilization Plan (ADERTUP)

The Commission, in Order No. 32053, required the DGIP to contain an assessment of advanced technologies that could be used to increase the penetration of DG. The Order specified:

*An Advanced DER Technology Utilization Plan which shall set forth the near, medium and long-term plans by which customers would install, and utilities would utilize, advanced inverters, distributed energy storage, demand response and EVs to mitigate adverse grid impacts starting at the distribution level and up to the system level. This Plan and associated implementation process shall also be submitted to the commission for approval in a subsequent proceeding, as appropriate.*

The Advanced DER Technology Utilization Plan shall, at a minimum, also include:

1. Plans to utilize grid support functionality embedded in advanced inverters, including autonomous controls and two-way communication to provide, among other capabilities, real-time PV output visibility to the system operator and also the ability to limit export of excess solar PV energy; [Section 4.2 of this DGIP]
2. Proposed requirements for new DG inverters to utilize state-of-the-art technical capabilities such that these system can provide autonomous grid support functions, enable active utility control of DG and provide ancillary services as grid conditions require; [Section 4.2 of this DGIP]
3. Stakeholder input in-the tariff development process by which standards for advanced inverters are adopted for inclusion in Rule 14H, prior to filing with the commission; [Stakeholder briefings, prior to this release of this plan, have been held with multiple stakeholders, and will continue with the creation of the DER-TWG.]

#### 4. Advanced DER Technology Utilization Plan (ADERTUP)

##### 3.2 Cost Allocation Implications

4. Plans to enable two-way communications with all customer-installed DG equipment using proposed AMI communications infrastructure or other suitable communications networks; [Section 4.1 of this DGIP]
5. Plans to utilize distributed energy storage, sited either on utility distribution infrastructure or on the customer side of meter, to mitigate impacts of high penetration solar PV systems [Section 4.3 of this DGIP]; and
6. Plans to utilize the technical capabilities of advanced inverters, energy management control systems and customer energy storage systems to develop non-export options for distributed generators as well as options to provide ancillary and other grid support services, and appropriate tariff provisions to accommodate this. [Section 4.6 of this DGIP]

The combined effect of the above technologies would become the foundation for creating a modern power grid. In a renewables-dominated electric grid, the capacity and load-balancing function, and assuring system reliability becomes complex and challenging.

The balancing function balances generating capacity with load. Historically, such balancing has been achieved by ramping power up and down to match the load on the system. A more modern solution is to create a control system that not only dispatches generation, but also reduces load through demand response (DR) capabilities (see Section 4.4) and increases load through electric vehicle (EV) charging and/or storing energy by other means (see Section 4.5). The modern grid also dispatches multiple forms of generation by interacting with DG via inverter commands (see Section 4.2) and by adding stored energy back into the grid (see Section 4.3).

System reliability becomes more complex in a renewables- and DG-dominated grid because intermittent generation is distributed throughout the transmission and distribution network. Nominal protection schemes are based on under-frequency events that occur because generation does not match load, with protective relays shedding load in preset blocks until the shedding of load matches the loss of generation. However, as DG has become more prevalent, including backfeed of energy through the substation, the protection schemes have become less effective because of the disconnect moving from load shedding to generation shedding as the amount of renewable DG shifts during the day. To address this, a more adaptive protection solution is needed; this is discussed at length in the PSIPs.

## 4.1 MODERN GRID

The modern grid vision is fundamental to long-term successful deployment of DG, and its components must be reviewed and incorporated into discussion of the Advanced Distributed Energy Resource Technology Utilization Plan (ADERTUP). The functions provided by a modern grid establish a foundation for controls that interact with the inverters, storage, demand response, and EVs. A primary component of a modern grid is an advanced metering infrastructure (AMI) that will provide two-way communications to the customer premises and that is a necessary prerequisite to interactions with advanced inverters, customer-sited storage, demand response through direct load control, and EVs. Beyond AMI, an advanced distribution management system (DMS) will be required to provide control of all devices and services within the distribution network. While these major solutions are larger than the scope of ADERTUP, it is necessary to provide an overview of the Companies' modern grid plans as a lead-in to the response for an ADERTUP.

### 4.1.1 AMI Overview

On March 10, 2014, Hawaiian Electric started an Initial Phase smart-grid project that involves approximately 5,200 customers and is designed to demonstrate smart-grid applications on Oahu's utility grid. The Initial Phase will provide empirical information that will help with the Companies' program design efforts for a full-scale smart-grid implementation program. This information will also be incorporated into the Companies' plan to file an application with the Commission in the fourth quarter of 2014.

On March 17, 2014, the Companies filed a Smart Grid Roadmap and Business Case with the Commission. The key elements addressed in the Smart Grid Roadmap include smart-grid applications, AMI, Volt/VAR Optimization (VVO), and Distribution Automation (DA).

#### Smart-Grid Applications

The smart-grid platform connects hardware devices with smart-grid applications. The Companies have selected a suite of these applications for the smart-grid implementation, based on the benefits they will deliver. **Figure 4-1** illustrates some of these applications and the benefits they can deliver.

## 4. Advanced DER Technology Utilization Plan (ADERTUP)

### 4.1 Modern Grid

Benefits	Applications		Description
Lower Electricity Bills	Volt / VAR Optimization		Allows utilities to more accurately control the level of power delivered to the end-consumer.
Expanded Customer Choices	Customer Energy Portal		Allows customers to monitor their bills and usage patterns to reduce energy consumption.
	Prepay		Provides customers the flexibility to pay as they use electricity to avoid deposits and help budget spend.
Increased Reliability	Advanced Metering Infrastructure		Enables automated billing for customers, reducing meter reading costs, as well as acts as a sensor for outage detection and many other applications.
	Outage Management		Helps utilities find outages on the grid to restore power to customers more quickly.
	Fault Circuit Indicator		Enables devices in the field to be remotely controlled to get an outage fixed more quickly.
Optimal Integration of Distributed Generation	Remote Switching		Enables devices in the field to be remotely controlled to get an outage fixed more quickly.
	Direct Load Control		Shapes energy demand to ensure the grid can safely manage variable energy sources such as renewable wind or solar.
Reduced CO <sub>2</sub> Emissions	Electric Vehicle Charging		Enables the scheduling of electric vehicle charging.

Powered by Silver Spring Networks Smart Energy Platform (Secure Communications Network)

Figure 4-1. The Companies' Smart-Grid Applications

The Companies will implement a core group of these smart-grid applications on each of the five islands served, customized and adjusted (scaled) to meet the specific needs of each island's grid and customer base. There are plans to implement other smart-grid applications on each island based on the benefits they can deliver.

### Advanced Metering Infrastructure

AMI is a foundational component of a smart grid, providing two-way communications to the customer premises and providing energy generation and consumption information in small time increments (see **Figure 4-2**). AMI can provide customers with information that enables them to monitor and manage their energy usage, making them true partners with the Companies in increasing energy efficiency and reducing costs. AMI can enable the Companies to offer their customers various pricing and payment programs (e.g., time of use, prepay metering, EV charging, and various solar applications) to better supervise their energy usage and costs. AMI information will also provide the Companies with important energy usage information throughout their distribution grid infrastructure, enabling them to monitor and quickly identify and prioritize the areas of the grid most at risk by DG operations.

AMI includes smart meters, a two-way communications network, and back-office software systems used to manage customer information systems (CISs), meter data, remote operations, network connectivity, and device upgrades. Smart meters are placed

at the customer premises to collect detailed and near-real-time information on energy usage, which is transmitted over a secure network to a meter data management system (MDMS) maintained by the utility.

The Companies will be able to communicate with the smart meters from their offices, allowing them to complete certain service requests (e.g., connecting and disconnecting power to a home) without rolling a truck, thus saving labor and fuel costs.

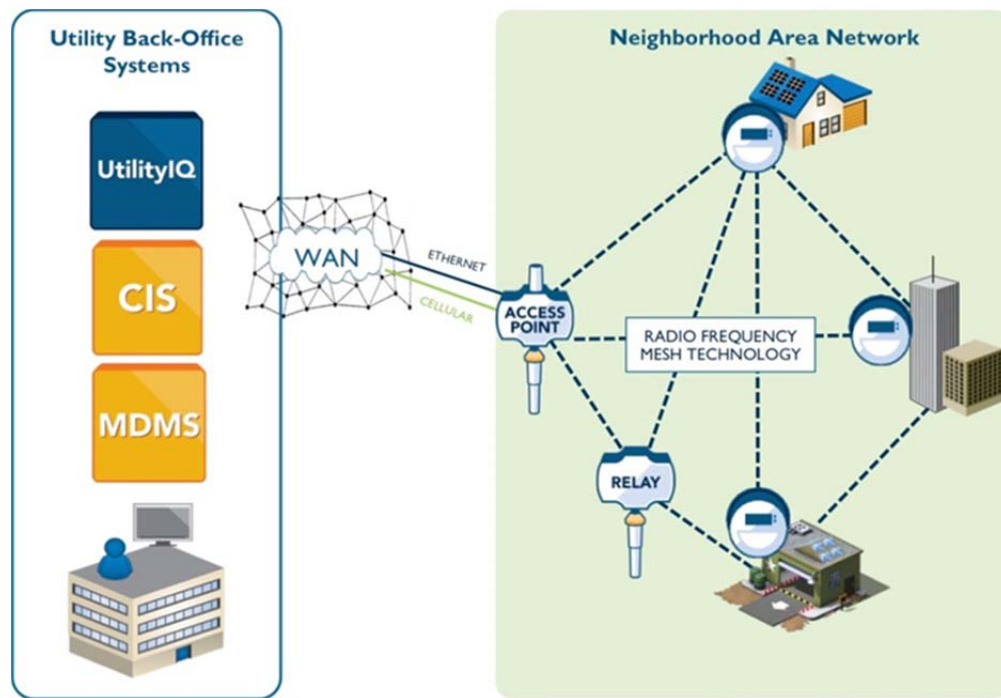

Figure 4-2. Advanced Metering Infrastructure (AMI) Example

### Volt/VAR Optimization (VVO)

A VVO application accurately monitors voltages at customer premises (through an AMI system) and optimizes them, saving energy. Tariff specifications govern how distribution voltages at customer endpoints are set and managed. Current practice is to set voltages levels between the top and middle of the specifications to ensure that customers at the end of the circuit receive proper voltage levels. By collecting real-time voltage data through AMI, the VVO application allows these values to be reduced (and flattened) closer to the lower limit of the tariff specifications (**Figure 4-3**), resulting in saved energy, lower energy bills, and less carbon dioxide emissions, all without requiring changes in customer behavior.



## 4. Advanced DER Technology Utilization Plan (ADERTUP)

### 4.1 Modern Grid

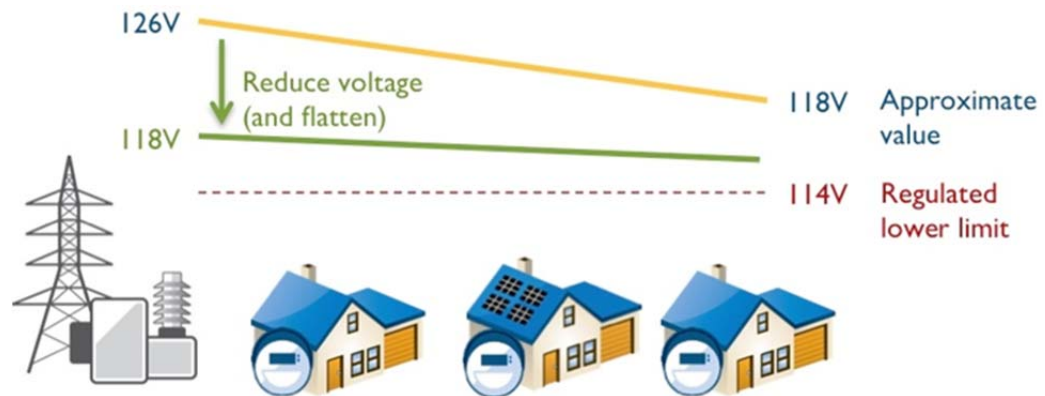

Figure 4-3. Volt/VAR Optimization Impact on Tariff Specifications

A VVO application controls VAR flows to regulate voltage on the distribution grid, ensuring that voltage levels remain safely within the regulated range, while reducing wasted energy.

The Companies' approach (**Figure 4-4**) will 1) use AMI to collect customer voltage readings, which then are 2) analyzed by the VVO application to 3) determine voltage set-point recommendations for substation controllers (e.g., load tap changers) and control operations for distribution circuit devices (e.g., capacitor banks) to 4) implement optimal voltage and potentially VAR control the circuit. The VVO application can monitor and track improvements to validate energy savings. VVO applications are important for the distribution grid, because they will monitor voltage at various points along it, including areas where voltages may be affected by DG operations. Furthermore, the system will eventually incorporate data from new points, such as advanced inverters. Unlike conventional VVO applications, VVO for the Companies will address voltage impacts from DG operations on the grid.

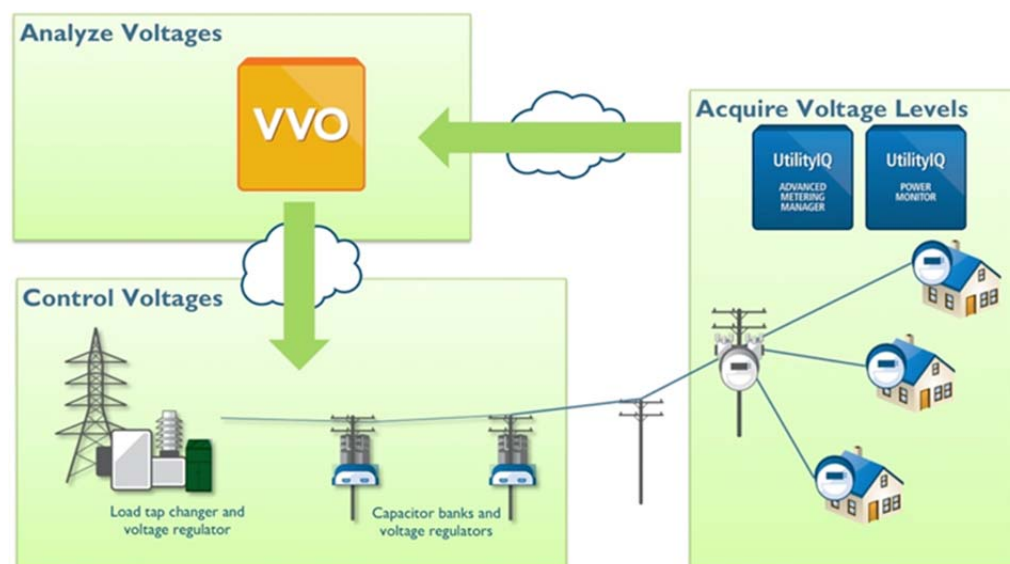

Figure 4-4. Volt/VAR Optimization Example

The Companies' VVO plan currently utilizes a centralized solution; in response to voltage readings at the edge, it will optimize voltage by adjusting devices farther upstream or at the substation. However, smart inverters may be another component of the solution because they will have the capability to provide dynamic reactive power injection – “VARs” – through autonomous responses to local voltage measurements (i.e., at customer sites with DG). They have the potential to provide distributed VAR support to resolve phase differences between voltage and current, reducing distribution losses and raising voltage levels at various points on the circuit, which can have a positive impact on power quality and distribution efficiency. Section 4.2 discusses smart inverters in depth, identifying the features that will be available in each phase of development. The key attribute for a long-term solution will be two-way communications to the inverter, providing the utility the opportunity (through a customer program) to control the inverter for VVO operations.

### Distribution Automation (DA)

The Companies' highest priority is to operate a safe, reliable electric grid, and a smart grid will help the Companies achieve this objective.

The smart grid will implement devices called fault current indicators (FCIs), which will make it possible to almost immediately isolate the location where a circuit outage has occurred, enabling restoration crews to expeditiously restore power. In addition, remote switching allows for routing of electricity around outage points, meaning that fewer customers will be affected by an outage (**Figure 4-5**). As a result, power is restored more quickly and operational cost savings are passed on to customers.

The DA Master Plan (DAMP) is currently being developed. The main goal of the DAMP is to install SCADA in all distribution substations to allow monitoring and control of all distribution level sources. The secondary goal of DAMP is to automate the feeders to provide downstream monitoring and control. Capacitor bank and line switch control that are used for VVO are part of the secondary goal. FCIs and FLISR type of schemes will also be part of the secondary goal of the DAMP.

## 4. Advanced DER Technology Utilization Plan (ADERTUP)

### 4.1 Modern Grid

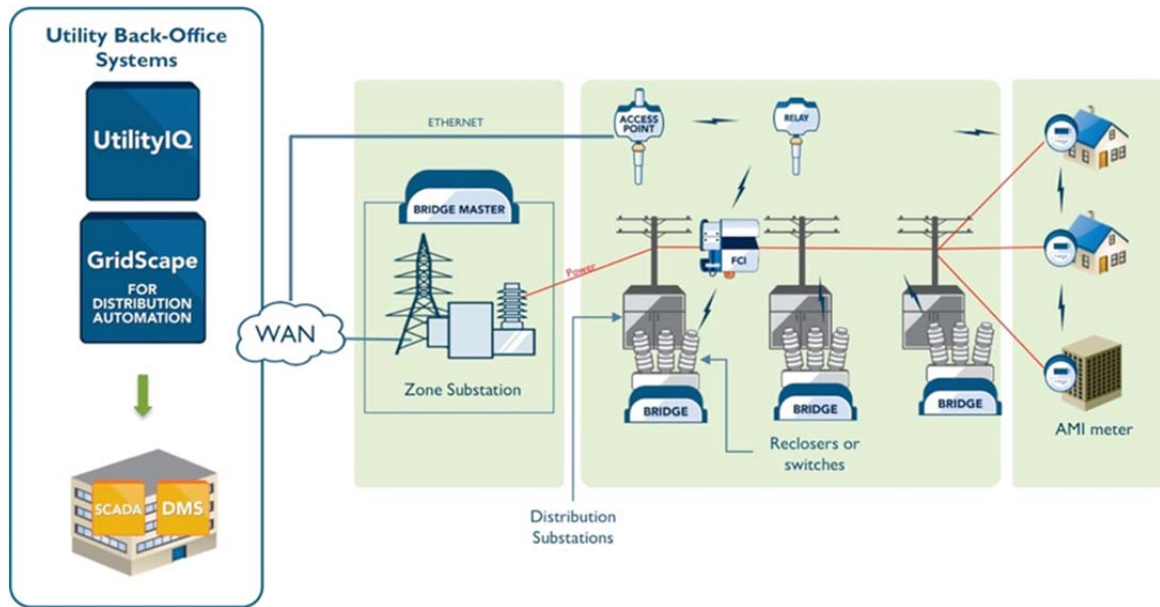

Figure 4-5. Distribution Automation Example

### 4.1.2 Advanced Distribution Management System (ADMS) Overview

The Companies have been investigating the benefits of deploying an Advanced Distribution Management System (ADMS) to help manage and integrate the new technologies and applications they plan to deploy as part of the DGIP and DCIIP. An ADMS is a single system that includes outage management system (OMS), DMS, and distribution SCADA components and functionalities in one platform with a single user interface for the operator. This combined solution builds on the recent evolution of control center applications, which is trending toward integrated solutions rather than independent systems, which required the utility to integrate and manage. The 2012 Hawaiian Electric OMS assessment recommended moving the OMS functionality to an ADMS if the DMS functionality could provide sufficient value to Hawaiian Electric to justify the added cost. Hawaiian Electric is in the planning process for implementation of an Oahu ADMS in the 2017-2019 timeframe, as was recently described in the Companies' Enterprise Information Systems Roadmap filed June 13, 2014 to the Commission.

Utilities traditionally have had a suite of disparate applications within the operations centers, as well as manual solutions. ADMS platforms are designed to bring together these disparate solutions into a single integrated platform, enabling information for the individual OMS, Distribution Automation (DA), Substations Automation (SA), and other systems to be combined in real time, which provides operators with improved visibility and more rapid identification of system changes and their potential impact. In addition, the DMS is intended to provide a level of integration, automation, control, and analysis that is not possible with conventional utility applications. As utilities move away from

the traditional utility distribution system environment of primary radial circuits and complete control over generation, new tools and solutions are required.

ADMS solutions have varying levels of support for specific feature sets, but in aggregate, utilities are using ADMS solutions to help achieve value in the following areas:

- **Safety** – ADMS provides operators with a real-time view of the distribution grid with online power flow and provides switch order management in automatic and manual modes.
- **Distributed Generation** – With increasing DG penetration, utilities need visibility into the DG in their network and must be able to accurately forecast and dispatch DG power.
- **Efficiency** – With the help of VVO, utilities can reduce their energy losses by improved management of voltage levels and VAR flows.
- **Resiliency** – Ability to locate faults more rapidly and to automatically restore after a fault using fault location, isolation, and service restoration (FLISR).
- **Reliability** – With more visibility into the distribution networks and control over network devices, utilities can reduce the frequency and duration of outages and improve their reliability indices.
- **Maintenance** – With the sensor, loading, and operational data collected, utilities can perform reliability-centered and condition-based maintenance to stretch the maintenance intervals of their equipment, which can reduce the need for corrective replacement of equipment.
- **Increasing Complexity of Distribution Grid** – The ever-increasing smart sensors, automated devices, and EVs are making the distribution grid more complex. An ADMS gives utilities the ability to reconfigure their networks optimally based on real-time information and metrics.
- **Demand Response** – An ADMS helps utilities reduce energy consumption by using conservation voltage reduction (CVR) or using ADMS Distribution Energy Resource Management modules.

The Companies have been involved in developing and evaluating business cases and pilots with ADMS. In addition to the planning being done for replacement of the O'ahu OMS with an ADMS, another project under consideration is an ADMS pilot on Maui that integrates several technologies and applications at the local level, in separate, autonomous micro-DMS installations. This "intelligence at the edge" provides for optimization of systems and technologies to mitigate issues before they migrate upstream. Optimization can occur at the building level, transformer level, or line or section level. The ADMS will be a hierarchical "manager of managers," integrating and

## 4. Advanced DER Technology Utilization Plan (ADERTUP)

### 4.1 Modern Grid

optimizing the various micro-DMS applications to ensure circuit and substation operational efficiency.

The pilot ADMS will incorporate three levels of technology management and monitoring, as follows:

- **Field Level**—Includes homes, businesses, and technology locations (i.e., Public EVSE locations). Smart power conditioning systems (PCS) will provide monitoring and control of devices within its purview. Smart PCS units will monitor real-time voltage and adjust accordingly to respond to system fluctuations.
- **Low-Voltage Level**—Occurs at the transformer level. The micro-DMS will optimize the different smart PCS units and curtailable loads that operate beneath it at the edge of the circuit.
- **Mid-Voltage Level**—Occurs on primary distribution circuits and at section switches and substations. The integrated ADMS is responsible for monitoring and controls at this level.

Micro-DMS controllers in each layer autonomously attempt to solve detected issues in their layer by maximizing onsite generation or controlling generation or load. Controllers on the same layer do not work with each other; there is no control or information path established. Although the goal of the micro-DMS controllers is to optimize operations within their domain, they can be overridden by the ADMS to implement actions to optimize the entire circuit.

The objective of the Maui pilot is to use ADMS to implement a virtual power plant (VPP). The VPP will have aggregation and integrated control of various distributed energy resources, including PV, energy storage, and EV and DR applications. Development of the pilot specifications is under way, with pilot installations scheduled for 2015.

#### 4.1.3 Increased Renewable Energy through Enhanced Modeling Tools

Hawaii has one of the nation's most aggressive programs for increasing renewable resources. Hawaii's Renewable Portfolio Standards (RPS) requires 40% of total energy needs to be met by renewable resources by 2030. Based on the current pace of rooftop solar installations, combined with proposed utility-scale renewable energy projects, it is expected that the target will be met, and possibly exceeded, on time.

The Companies are working to accommodate increased customer demand for rooftop solar (and other DG systems, such as micro-hydroelectric turbines). The challenge, however, is that an increasing number of the Companies' distribution circuits now have a high percentage of DG. During daytime hours, there are periods when more power is being generated than consumed on specific distribution circuits. Under such

circumstances, an engineering analysis is required to determine the mitigation measures and to design requirements to avoid power quality and reliability problems.

To mitigate the effects of these potential unsafe operating conditions, protective upgrades are being installed to circuits (or customers are required to install protective equipment as part of their systems) and, in some cases, the amount of rooftop solar connected to a given distribution circuit is being limited. Without more precise power flow and voltage information at customer locations on a distribution circuit, these restrictions are imposed by relying on historical estimates of customer use and the design specifications of their rooftop solar systems. Smart-grid applications, in particular AMI, VVO, and ADMS, will feed accurate information on power flow and generation from both individual customers and distribution circuits. This usage information allows the Companies to more accurately assess whether more rooftop solar capacity can be accommodated on a distribution circuit without risking unsafe operating conditions.

Smart-grid applications provide system operators with more accurate, near-real-time information about customer-sited demand and generation throughout the service territories. Real-time visibility of the amount of variable generation on distribution circuits will also help system operators observe the contribution that distributed solar makes to total system generation, which can be useful in allocating reserves to balance the system generation. Visibility of distributed solar production can be used to improve solar power forecasting tools by providing actual production feedback, which can be used to correct forecasting models. Improved forecasting is essential to helping system operators optimize the dispatch of transmission-connected generation, which could reduce the costs incurred by the uncertainty in the forecast that exists today. Taken together, it is expected these operational improvements will increase the reliability and use of renewable energy.

Detailed modeling should include time-series analysis tools to aid in more accurately simulating the changes between load and DER. Load tap changer cycling and flicker are some of the issues that cannot be modeled with traditional “steady-state” modeling.

Models currently include mostly the utility assets up to the distribution service transformer, however recently it has been discovered that possible over voltages can occur due to large amounts of excess power output and inadequately sized secondary cable. In some cases, secondary over voltages can impact customers without DER. Thus, it is recommended that modeling try to incorporate higher levels of detail to include the secondary cables up to the customer service entrance.

## 4. Advanced DER Technology Utilization Plan (ADERTUP)

### 4.1 Modern Grid

#### 4.1.4 Two-Way Communications

The Edison Foundation's Institute for Electric Efficiency (IEE) estimates that there will be approximately 65 million smart meters deployed in the United States by the end of 2015,<sup>19</sup> that 77% of the deployments will be carried out by investor-owned utilities, and that 90% will be serving residential customers.<sup>20</sup> A variety of communications technologies and networks have been deployed to support these endpoints, including public carrier (cellular), licensed radio frequency (RF) spectrum, power line communications, and, especially, 900 MHz private RF networks. Because AMI is only one part of a smart-grid platform and one of many possible communicating endpoints in a deployment, the need to select, plan, design, and build a robust, ubiquitous, secure, and flexible two-way communications network is paramount.

Communications is the key enabler for grid modernization because it allows for timely use of the data that, to date, have been either unavailable or unusable across silos. The exchange of these data across multiple endpoints and energy applications enables true grid transformation.

Therefore, as AMI becomes more widely adopted, the industry is shifting its focus, but continuing to leverage the smart metering functionality, toward incorporating other energy applications, including Customer Energy Portal, Prepaid Meters, Volt/VAR Optimization (VVO), Distribution Automation (DA), and Direct Load Control (DLC). Longer-term planning for emerging technologies (e.g., EV charging, smart inverters, networked street lights, and community and residential energy storage [CRES]) has begun. All of these applications will require two-way communications to unlock the full value of their data sets and to monitor these assets as they are deployed.

Building a communications network that can support multiple applications, versus building single, purpose-driven networks per solution, requires an understanding of the data, bandwidth, and latency requirements of each while identifying common infrastructure elements across multiple application categories. The Companies believe it requires multiple technologies to realize the future-state vision for the grid. These solutions have and likely will continue to have disparate and often variable communications requirements. The Companies are mitigating this risk by adopting a packet-based common network that can meet the variable requirements of today and the potential requirements in the future.

The backbone of the Companies' telecommunications system, commonly referred to as the wide area network (WAN) and field area network (FAN) is fully owned by the

---

<sup>19</sup> Edison Foundation Institute for Electric Efficiency. Utility-scale Smart Meter Deployments, Plans & Proposals. May 2012.  
[http://www.edisonfoundation.net/iee/documents/iee\\_smartmeterrollouts\\_0512.pdf](http://www.edisonfoundation.net/iee/documents/iee_smartmeterrollouts_0512.pdf).

<sup>20</sup> Ibid.

Companies and serves as an enabler for all of the operational and corporate business applications, including the smart-grid applications. The smart-grid applications and end devices, such as smart meters and FCIs, reside in the neighborhood area network (NAN), which is located beyond the WAN and FAN networks. The Companies are designing the FAN to overreach into the NAN to ensure that critical protective relay functions used for DA applications have priority on the telecommunications system. Otherwise, having such systems on the NAN may cause the NAN to be overtaxed and overbuilt for one DA device. The foundation of the smart-grid platform (i.e., the NAN) that the Companies intend to develop and implement is a two-way communications network that connects NAN applications to Tier 4 demarcation points (see **Table 4-1**). Smart-grid applications run on that network, providing detailed information about the performance of the distribution grid.

The Companies' Smart Grid Initial Phase includes implementing Silver Spring Networks' IPv6 platform as the NAN, which will ensure they can implement standards-based networking throughout the electric distribution grid infrastructure, thus delivering a secure, common platform for a variety of specific smart-grid applications. The smart-grid network connects devices across the distribution system and transports data from those devices to access points connected to the nearest FAN or WAN. These data are carried to back-office software applications that provide utility personnel with greater visibility into and the possibility for greater control of, the grid, especially at the distribution level. While the Silver Spring network will be used for the Initial Phase smart-grid data, the companies will continue to own the FAN and WAN at the operating utilities. The network also is the foundation for other NAN applications – both existing and emerging – that the Companies and their customers can phase in over time.

The following Technology Model is provided to guide discussion on the selection and design of the Companies' system architecture. The Technology Model presently defines the various tiers of the communications infrastructure and the physical components of each tier, and is updated as required.

Given the definition of each of the five tiers listed in **Table 4-1**, the Companies' engineering, operations, system operation, ITS, and planning groups will make the determination as to which specific substations, sites, interconnected generation, and so on belong to each tier, as shown in **Table 4-1**.



## 4. Advanced DER Technology Utilization Plan (ADERTUP)

### 4.1 Modern Grid

Tiers 1–5	Communications Media Minimum Requirements	Site Qualifications
Tier 1: Core Sites Highest Capacity Critical Availability	<ul style="list-style-type: none"> <li>■ Company–Owned Redundant</li> <li>■ Diverse Route</li> <li>■ Fiber Optic Media</li> <li>■ Leased Dark Fiber, if acceptable</li> <li>■ Core Site (40 Gbps)</li> <li>■ Edge Site (10 Gbps)</li> </ul>	<ul style="list-style-type: none"> <li>■ Primary and Backup Control Centers</li> <li>■ Primary and Backup Network Operations Centers (Communications and IT, Collocated with Primary or Backup Control Centers)</li> <li>■ Utility–Owned Power Plants</li> <li>■ Critical Transmission Substations</li> <li>■ Critical Offices</li> <li>■ MEVA Transmission Sites (for the Companies)</li> <li>■ IPPs and IPP Switching Stations that Provide Firm Energy</li> </ul>
Tier 2: Primary Stations High Capacity High Availability	<ul style="list-style-type: none"> <li>■ Company–Owned Redundant</li> <li>■ Diverse route</li> <li>■ Fiber Optic (Preferred)</li> <li>■ Microwave</li> <li>■ Mixture of Both</li> <li>■ Leased dark fiber, if acceptable</li> <li>■ Edge Sites (1 Gbps)</li> </ul>	<ul style="list-style-type: none"> <li>■ Remainder of Transmission Substations</li> <li>■ Critical Distribution Substations</li> <li>■ Critical Interconnected Generation</li> <li>■ Base Yards or Corporate Offices</li> <li>■ Critical Communications Sites</li> <li>■ MEVA Distribution Sites (for the Companies)</li> </ul>
Tier 3: Secondary Stations Medium Capacity Good Availability	<ul style="list-style-type: none"> <li>■ Licensed Single Feed MW/Radio or Fiber Optic Media</li> <li>■ Redundant Where Possible and as Required</li> <li>■ Leased Facilities, if acceptable</li> <li>■ 6 Mb minimum</li> </ul>	<ul style="list-style-type: none"> <li>■ Remainder of Distribution Substations</li> <li>■ Small/Non–Critical Interconnected Generation</li> <li>■ Remainder of Communications Sites</li> <li>■ Remote or Satellite Offices</li> </ul>
Tier 4: Service Points Low Capacity	<ul style="list-style-type: none"> <li>■ Non–Redundant</li> <li>■ Licensed Radio Link</li> <li>■ Unlicensed Radio Link</li> <li>■ Leased Facilities, if acceptable</li> </ul>	<ul style="list-style-type: none"> <li>■ MAS Consolidation Nodes</li> <li>■ LMR Base Stations</li> <li>■ Take–Out Points for AMI or SG</li> </ul>
Tier 5: End Devices Single Circuit Single System/Service	<ul style="list-style-type: none"> <li>■ Non–Redundant</li> <li>■ Vendor–Provided Radio Link</li> <li>■ Carrier–Provided Wireless Link</li> </ul>	<ul style="list-style-type: none"> <li>■ Mobile Workforce Data</li> <li>■ Land Mobile Radio (LMR) Devices</li> <li>■ Distribution Automation (DA) Devices (i.e., Reclosers, LTC, FCI)</li> <li>■ Advanced Metering Infrastructure (AMI) Meter—Residential and Commercial—TMP to Provide Communications to Take–Out Points ONLY</li> </ul>

Tiers 1-5	Communications Media Minimum Requirements	Site Qualifications
		<ul style="list-style-type: none"> <li>■ Home Area Network (HAN) Devices (Past the Meter)</li> <li>■ Demand Response (DR)—Load Control Switches, and Others</li> <li>■ All Other Stakeholder Applications' End Devices</li> </ul>

Table 4-1. Tiers of Communication Infrastructure

As the design progresses, each tier will be characterized and have its requirements identified with regard to the following criteria:

- Applications supported
- Latency restrictions
- Bandwidth delivery
- Interface requirements
- Security exposure.

Bandwidth delivery requirements and latency restrictions vary across multiple smart-grid applications. Focusing on the applications that are intended for the NAN (Tier 5 and some Tier 4 considerations), **Table 4-2** lists communications requirements for some of the intended smart-grid technologies the Companies expect to deliver.

## 4. Advanced DER Technology Utilization Plan (ADERTUP)

### 4.1 Modern Grid

Application	Current Functional Requirements					
	Latency	Bandwidth	Coverage	Reliability	Security	Backup Power
AMI	2-15 sec	10-100 kbps/node, 500 kbps for backhaul	20-100%	99-99.99%	High	Not necessary
Demand Response	500 ms-several minutes	14 kbps-100 kbps per node/device	20-100%	99-99.99%	High	Not necessary
Distribution Energy Resources and Storage	20 ms-14 sec	9.6-56 kbps	90-100%	99-99.99%	High	1 hour
Electric Vehicles	2 sec-5 min	9.6-56 kbps; 100 kbps is a good target	20-100%	99-99.99%	High	Not necessary
In-Home Displays	300-2000 ms	9.6-56 kbps	20-100%	99-99.99%	High	1 hour
Automated Circuit Switching	300-2000 ms	9.6-56 kbps	20-100%	99-99.99%	High	8-24 hours
Distribution Grid Management <sup>21</sup>	100 ms-2 sec	9.6-100 kbps	20-100%	99-99.999%	High	24-72 hours <sup>22</sup>

Table 4-2. Smart-Grid Applications and Communications Requirements

#### 4.1.5 Smart-Grid Roadmap

The roadmap for implementing a smart grid across the Companies' areas consists of two implementation phases, as follows:

- *Initial Phase*—Demonstrate a suite of smart-grid applications on a limited number of circuits that represent statewide demographics and geography, and engage customers in a dialogue about smart-grid benefits.
- *Full Implementation*—Complete installation of smart grid to all customers with a suite of applications deemed to garner the best customer benefit, individualized for each island served.

<sup>21</sup> Utilities Telecom Council, Comments-Request for Information on Smart Grid Communications Requirements. July 12, 2010.  
[http://energy.gov/sites/prod/files/gcprod/documents/UtilitiesTelecom\\_Comments\\_CommsReqs.pdf](http://energy.gov/sites/prod/files/gcprod/documents/UtilitiesTelecom_Comments_CommsReqs.pdf).

<sup>22</sup> Department of Energy. Communications Requirements of Smart Grid Technologies. October 5, 2010.  
[https://www.smartgrid.gov/sites/default/files/Smart\\_Grid\\_Communications\\_Requirements\\_Report\\_10-05-2010.pdf](https://www.smartgrid.gov/sites/default/files/Smart_Grid_Communications_Requirements_Report_10-05-2010.pdf).

## Smart-Grid Implementation Overview

Figure 4-6 depicts the Companies’ past and proposed future activities for implementing a smart-grid platform.

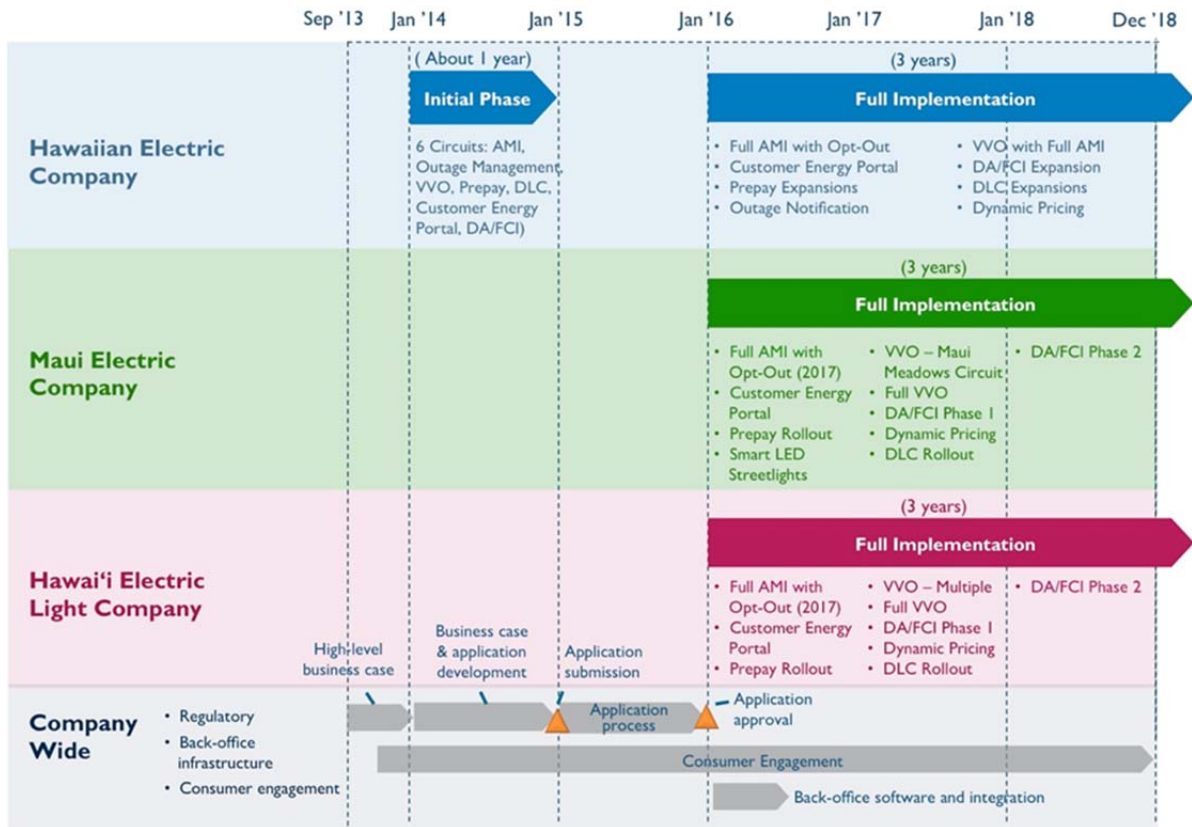

Figure 4-6. Smart-Grid Implementation Overview

### Initial Phase

During the Initial Phase, Hawaiian Electric is implementing a smart-grid program on Oahu with the following two primary objectives:

- Demonstrate the technology
- Engage customers.

The Initial Phase demonstration will implement a suite of smart-grid applications, including AMI, Customer Energy Portal, Prepay, VVO, Distribution Automation (DA) with FCIs, Outage Management, and DLC for about 5,200 customers across six circuits. The Initial Phase circuits represent statewide demographics and geography so that the smart grid is demonstrated in a broad array of environments.

The Initial Phase is designed to test many critical capabilities (Table 4-3) to demonstrate the capabilities on the Companies’ grids. The Companies decided not to test other capabilities because they have been demonstrated or proven to work at other utilities.

## 4. Advanced DER Technology Utilization Plan (ADERTUP)

### 4.1 Modern Grid

Technology Capability	Initial Phase	Full Implementation	Key to Managing DG
Automated Meter Reading	Yes	Yes	Yes
Billing from Automated Reads	No	Yes	No
Remote Connects and Disconnects	Partial	Yes	No
Theft Detection	Yes	Yes	No
Outage Management	Partial	Yes	Yes
Customer Energy Portal	Yes	Yes	Yes
Prepay	Yes	Yes	No
Volt/VAR Optimization (VVO)	Yes	Yes	Yes
Distribution Automation (DA) (remote switching/fault circuit indication)	Yes	Yes	Yes
Direct Load Control (two-way load control switch)	Yes	Yes	Yes
Dynamic Pricing	No	Yes	Yes

Table 4-3. Smart-Grid Capabilities for the Initial Phase and Full Implementation

While conducting the Initial Phase demonstration, Hawaiian Electric will develop a smart-grid project application filing that encompasses the three operating utilities across five islands. The purpose of filing the application is to seek approval for the full smart-grid implementation. The application will detail costs and benefits of the smart grid and be tailored to each operating utility's requirements and capabilities.

Also during the Initial Phase demonstration, the Companies will begin engaging customers to educate them about the smart grid and how it can benefit them.

### Full Implementation

During Full Implementation, the Companies will provide the necessary infrastructure and install the devices necessary for a smart grid, including back-office systems, smart-grid NAN infrastructure, utility FAN and WAN infrastructure (separate from the smart-grid project), sensor endpoints, and services to manage the network. They also will install the smart-grid applications that will have the most positive impact on customers, such as AMI, Customer Energy Portal, Prepay, VVO, DA, and demand response. The Companies expect to complete full implementation for Maui Electric and Hawai'i Electric Light in 2017 and for Hawaiian Electric in 2018. Because implementation involves tailoring the smart grid to meet the unique needs of customers on each island, the implementation timeline is different for each operating utility. For details on the roadmap, refer to the Smart-Grid Roadmap and Business Case filed with the Commission on March 17, 2014.

## 4.2 ADVANCED INVERTERS

Inverters are a fundamental component of a PV system (as well as other forms of DG systems). The inverter is the primary point of connection between the power grid and the on-premises equipment. The primary purposes of inverters to date have been to convert the power to usable AC power and to meet the interconnection requirements of the utility. Specifications for inverters continue to evolve, but as DG penetration has increased, it has become evident that the inverter must become more advanced – “smarter.” The primary means for achieving this is by interconnecting the inverter, via two-way communications, to the utility. Connected inverters can then be controlled and the status of the inverter can be better used.

### 4.2.1 Advanced Inverters Overview

Substantial quantities of DG capacity have been and will continue to be added to the Companies’ utility grids. To date, there has been 309 MW of installed solar PV capacity, most of which is residential rooftop systems. Furthermore, the Companies are forecasting to have 546 MW of installed capacity through 2016. (See Section 8, **Table 8-2** for a breakdown of installed capacity by utility.) Given the rapid growth of PV in Hawaii, it is imperative for safety, reliability, and operational efficiencies that the inverters in any installation provide capabilities not only for today, but also for the future.

In response to the continued growth of PV, it is paramount that future inverters support not only standard inverter requirements (e.g., power transfer optimization, voltage conversion, grid synchronization, disconnection, anti-islanding protection, and storage interfacing), but also advanced capabilities that allow for reactive power control and voltage and frequency ride-through responses, with other features listed in Section 4.2.4. In attempts to future-proof inverter installations throughout the Companies’ systems, advanced inverter functionalities represent a significant opportunity to improve the stability, reliability, and efficiency of the electric power distribution and transmission systems, particularly as DG becomes incorporated onto the grid at higher penetration levels.

When advanced inverters are coupled through advanced two-way communications with augmented protection and intelligent control, these interconnected advanced inverters could have significant beneficial impact on the efficiency and reliability of the distribution system. Utility distribution automation and DMSs are central to the integration of these functionalities.<sup>23</sup>

<sup>23</sup> Smart Inverter Working Group, “Recommendations for Updating the Technical Requirements for Inverters in Distributed Energy Resources, January 2014.

## 4.2.2 Current State of Inverter Requirements

The main standards that govern inverters are IEEE 1547a-2014 “Standard for Interconnecting Distributed Resources with Electric Power Systems” and UL 1741 “Standard for Safety for Inverters, Converters, Controllers and Interconnection System Equipment for Use with Distributed Energy Resources.” IEEE 1547a-2014 establishes criteria and requirements for the interconnection of DG with electric power systems; UL 1741 references and expands on IEEE 1547a-2014, specifically addressing safety concerns related to grid-connected power generators, including the protection against risk of injury to persons.

With the above standards, some basic functionalities and capabilities have been put in place for inverters, including power transfer optimization, voltage conversion, grid synchronization, disconnection, anti-islanding protection, and storage interfacing, as follows:

- **Power Transfer Optimization**— Inverters are designed to optimize the transfer of power from a DG unit to a load, often through a technique called Maximum Power Point Tracking (MPPT). Optimization typically is achieved through the design of an algorithm that computes the ideal equivalent resistance from measurements of current, voltage, and the respective rates of change. MPPT is subsequently implemented by an intelligent controller that makes frequent calculations and actuates corresponding adjustments.
- **Voltage Conversion**— To supply power to a load or to the distribution grid, power generated by a DE resource usually must be delivered at a different voltage. Often, as in the case of solar PV generators, this resource's generation voltage is different from the primary distribution voltage in the United States. Therefore, the primary function of the inverter is to match the DG and utility-grid voltage.
- **Grid Synchronization**— A central component of an inverter's efficacy is the ability to construct an output AC waveform that is synchronized with the utility distribution system. The supply of a waveform whose frequency is identical to the grid frequency is the key requirement of the grid synchronization functions.
- **Disconnection**— When fault conditions are present, a grid-tied inverter is required to disconnect from the distribution system at the point of common coupling (PCC). IEEE 1547 outlines the unacceptable, fault-indicating values of frequency and voltage based on the magnitude and duration of the signal. If either parameter rises or falls to such an extent in response to an event, and then remains at such a level for a prescribed duration of time after the event, the inverter must initiate a disconnection from the grid.
- **Anti-Islanding Protection**— Unintentional islanding is a potentially damaging system configuration that may occur when there is an open point caused by a

switching or an under-frequency event. The formation of a localized grid is initiated by a blackout or disconnection from the distribution network, and the entirety of the local load is transferred to the DG units that remain connected. Although the potential for a distribution system incorporating intentional localized grids connected to DG units, or microgrids, is a compelling technical advance, especially at high levels of DG penetration, electrical islanding carries a range of potential consequences when unintentional and without proper control strategies in place.

- **Storage Interfacing**— An inverter may enable the integration of a battery or other energy storage device with a distributed generator. When active power is produced by a distributed generator, a standard inverter will route the power to the grid.

### 4.2.3 Modern Inverter Features

Under the latest version of IEEE 1547a-2014, new voltage and frequency ride-through requirements were created. These new features are of high importance to the Companies because they address urgent system reliability needs on each island system:

First, the features provide ride-through of low/high frequency and voltage excursions beyond normal limits. Ride-through may be defined as the ability of an electronic device to remain connected through temporary fault transient voltage and frequency off-normal conditions that occur on the power system. The previous IEEE 1547-2003 standard required a “must trip” for off-normal conditions, which resulted in “nuisance trips” during conditions that are associated with the power system and not indicative of an unintentional island or circuit problem. A ride-through is required to ensure there is no aggregate loss of DG during reasonably anticipated power system transients and ensures a minimum period for which these resources must remain connected and producing energy (i.e., a minimum “must stay connected” requirement rather than a “must trip” requirement). This will increase the power system reliability and reduce the negative impact on the power system that occur due to aggregate loss of DG during the frequency and voltage deviations that routinely occur during normally cleared faults and contingencies.<sup>24</sup>

New stipulated voltage and frequency ride-through requirements have been submitted to the Commission for consideration. These features are extremely important for improving overall system reliability.<sup>25</sup>

<sup>24</sup> Advanced Inverter Technologies Report, Grid Planning and Reliability Energy Division.” <http://www.cpuc.ca.gov/NR/rdonlyres/6B8A077D-ABA8-449B-8DD4-CA5E3428D459/0/CPUCAdvancedInverterReport2013FINAL.pdf>.

<sup>25</sup> Docket 2011–0206, Second Stipulation Regarding Work Products Submitted As a Part of the January 18, 2013 Final Report of the PV Sub-Group for the Reliability Standards Working Group, Filed June 12, 2014. Please see Revised Sheets No. 34B–16 and 34B–17.





## 4. Advanced DER Technology Utilization Plan (ADERTUP)

### 4.2 Advanced Inverters

New inverters also must support fast-trip capabilities. TrOV concerns, as described in previous sections, require that inverters in highly congested circuits have shutoff features that minimize transient over-voltage. Unfortunately, there is no current specification or test mechanism to ensure inverters properly perform under such conditions. The Companies are working with the inverter industry to identify inverters that have proper shutdown characteristics, and the Companies will continue to look to standards bodies to establish criteria for the shutdown of an inverter that does not create TrOV situations.

#### 4.2.4 Advanced Inverter Features

As technologies advance, so does the need to modify and adapt standards. The California Public Utilities Commission (CPUC) recently created the Smart Inverter Working Group (SIWG) to propose updates to the technical requirements of inverters. A recommendation for smart inverter functions was filed with the CPUC in February 2014. Many of these recommendations are relevant to the Companies and are the basis for the advanced feature set and roadmap defined below.

To help the Companies interpret and apply the SIWG recommendations on inverters, the Companies retained EPRI as an expert to review and consult in key areas. The findings on advanced inverters research were the result of programs directed and facilitated by EPRI and the SIWG of the CPUC. The SIWG work identifies future inverter capabilities that will be requested of the inverter industry and is broken out into three phases of capabilities as shown in **Figure 4-7**.

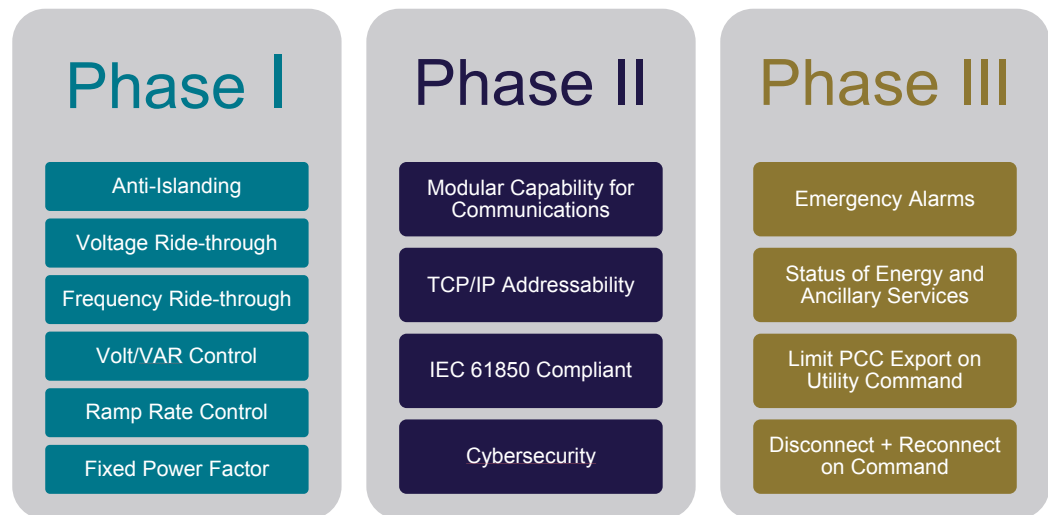

Figure 4-7. Advanced Inverter Feature Sets<sup>26</sup>

<sup>26</sup> "Recommendations for Updating the Technical Requirements for Inverters in Distributed Energy Resources," Smart Inverter Working Group of the California Public Utilities Commission, Jan. 2014.

According to SIWG, commercial availability for Phase 1 capabilities is planned for by the end of 2015, Phase 2 functions in the beginning of 2016, and Phase 3 functions by the end of 2016.

Surpassing the standard inverter scope of today, an advanced inverter will include the capacity to supply or absorb reactive power, to control and modulate active power exported to the power system in response to grid frequency and voltage, and to provide more robust safety and reliability functionalities in voltage and frequency ride-through, which is called out in Phase I by the CPUC and SIWG. Further, the SIWG considers advanced inverter functions involving two-way communications (i.e., to be able to support both monitor and control functions, to be TCP/IP addressable, to be IEC 61850-compliant, and to provide cybersecurity) a Phase II goal. The SIWG's Phase III comprises functions that require the communication of Phase II, such as alarms, status, output limiting, and directed connection and disconnection.

The features most needed for implementation in Hawaii that will directly address DG adoption include voltage and frequency ride-through, standard communications capabilities to the inverter, fixed power factor settings adjustments, and the ability to manage inverter output. Longer-term, additional features, such as those for volt/VAR or fixed power factor controls, will be desirable for future circuit level reliability improvements.

It is practical to use only the inverter features that are built to industry standards, such as IEEE 1547, and that are then tested to UL standards (UL-approved is a requirement of Rule 14H). The Companies have already requested voltage and frequency ride-through features in the second stipulation to the ruling on the RSWG work.<sup>27</sup> This request complies with the latest release of IEEE 1547 (IEEE 1547a-2014). The SIWG does not expect standardized communications and curtailment features to be industry-available until 2016. Consequently, broad adoption is likely to be in the mid-term, not short-term. As the new advanced inverter technologies are transitioned, it is important to note that new equipment cannot generally be installed on the grid until it is confirmed that it meets the new industry standards.

---

<sup>27</sup> Stipulations filed May 28, 2014, and June 12, 2014, regarding RSWG PV Sub-Group Work Products Pursuant to the PUC Order No. 32053.

## 4. Advanced DER Technology Utilization Plan (ADERTUP)

### 4.2 Advanced Inverters

#### Phase I

For Phase I, the utilities would like to require that DG systems be capable of the key functions described below, although not all of these functions would necessarily be activated initially. The reasoning is that the utilities could then test and assess the impact of different DG functions on the reliability and power quality of the grid:

- **Support anti-islanding to trip off under extended anomalous conditions** – Anti-islanding protection requires DG systems to disconnect or otherwise cease to energize an unintentionally created electrical island when the electrical system is de-energized, with the purpose of ensuring the safety of personnel and equipment that might come in contact with that electrical island. Within Phase I, the historically recommended anti-islanding trip settings have been modified by Rule 14H and the inverter must operate as expected with the new settings.<sup>28</sup>
- **Provide volt/VAR control through dynamic reactive power injection through autonomous responses to local voltage measurements** – A DG interconnected advanced inverter has the capacity to act as a supply of reactive power. Inductive loads are inherent in the distribution system. The presence of such loads results in a phase difference between voltage and current waveforms, causing losses that reduce the efficiency of real power distribution. Less efficient power distribution requires greater current, which magnifies the impact of line losses and of drops in the voltage profile over the distribution line. Reactive power control, or “VAR control,” in inverters provides intelligent supply of reactive power in response to these issues. Appropriately modulated reactive power support resolves phase differences between voltage and current, reducing distribution losses, raising voltage levels, and significantly affecting local power quality and distribution efficiency.<sup>29</sup>
- **Define default and emergency ramp rates as well as high and low limits** – DG systems can ramp up or ramp down the rate of increasing and/or decreasing their power output. The purpose of establishing ramp-up and ramp-down rates for DG systems is to smooth out the transitions from one output level to another output level. Although a single DG system might not affect the grid through a single sharp transition, aggregated DG systems responding to a specific event could cause significant rapid jumps in overall output if they do not ramp up or down to the new level. Such sharp transitions could cause power quality issues.<sup>30</sup>
- **Provide reactive power by a fixed power factor** – Operation of an electric power system is most efficient if it has zero reactive power and thus, has the optimal power

---

<sup>28</sup> “Recommendations for Updating the Technical Requirements for Inverters in Distributed Energy Resources,” Smart Inverter Working Group of the California Public Utilities Commission, Jan. 2014.

<sup>29</sup> “Recommendations for Updating the Technical Requirements for Inverters in Distributed Energy Resources,” Smart Inverter Working Group of the California Public Utilities Commission, Jan. 2014.

<sup>30</sup> “Recommendations for Updating the Technical Requirements for Inverters in Distributed Energy Resources,” Smart Inverter Working Group of the California Public Utilities Commission, Jan. 2014.

factor (PF) of 1.0. However, different types of loads and DG systems can supply or absorb reactive power, thus operating at off-unity PF. The purpose of establishing fixed power factors in DG systems is to compensate for loads and other DG systems that generate reactive power, resulting in better voltage regulation across the circuit and potentially mitigating localized high voltages at the service level.<sup>31</sup>

- **Reconnect by “soft start” methods**— After an outage, when power is restored, the DG systems on that circuit must reconnect to start generating power. If all DG systems started to output real power exactly at the same time, the circuit could experience a sharp transition, which could cause instability and, possibly, voltage spikes or even sharp frequency increases. The purpose of the reconnection by “soft-start” is to reduce these sharp transitions by ramping or staggering the reconnections of the DG systems.<sup>32</sup>

The above-mentioned functions and features are what make an inverter “advanced.” Review of existing inverters of the Companies and products shows that most of the advanced features have yet to be incorporated, piloted, or implemented, with the exception of the revised anti-islanding features, which are incorporated in the new IEEE 1547a-2014. (This is the function already requested for incorporation by the Companies.)

With increased reliance on these advanced inverters to provide grid support features that help maintain grid reliability and power quality, there is a growing concern with cybersecurity of these inverters, because future generation and load planning likely will be affected by the ability of such advanced features to be perpetually carried out by the inverter throughout its life cycle. During test and evaluation of the advanced inverter features while under the technology maturation process, cybersecurity will be one of the primary areas assessed by the Companies.

## Phase II

The above features are specific to Phase I of the SIWG recommendations, but in Phase II, the above features become manageable via a two-way communications system. A two-way communications system must follow the recommendations of the SIWG, which includes support to allow monitor and control functions to be TCP/IP addressable, IEC 61850-compliant, and to provide cybersecurity at the transport and application layers, as well as user and device authentication. Work in Phase II has begun within the industry; for example, the SunSpec Alliance is a trade alliance of distributed energy industry participants, together pursuing information standards to enable plug-and-play system interoperability through the use of a Modbus protocol suite. The Companies plan to further explore technology options to assist with the development of Phase II.

---

<sup>31</sup> Ibid.

<sup>32</sup> Ibid.

### Phase III

Phase III will specify the DG functions that require or benefit from the use of two-way communications and from allowing the functions within Phase I, with additional functions that can provide significant benefits to safety and power system operations. If the additional DG functions are not defined, manufacturers may not implement them, and they certainly will not be implemented in interoperable or consistent ways.<sup>33</sup>

Alarm features will allow an inverter to report issues with its performance or configuration. Combined with new status features, the advanced inverter will be capable of full two-way interaction with the utility, and near-real-time status of the inverter output may be available to the utility. These features will enable the utility to better characterize inverters on the distribution network and lead to a more feature-rich interaction with customers. With the ability to interrogate the inverter, the utility can fully characterize the load at the premises, which is masked today. This improved characterization of the inverter will support a more complete view of network load and generation, which in turn will lead to a more accurate determination of circuit limits. Creating customer portals will place the utility in a better position to fully serve DG customers by providing insight into the operations of the inverter.

The advanced inverter will provide the ability to control the power output of the inverter and, in extreme cases, will allow the utility to command connection or disconnection. This feature is mandatory if the utility is to achieve high levels of DG penetration because some form of output control is required to manage excess energy on the grid. System reliability constraints present on today's network may be fully addressed only when the ability to curtail inverters is provided. Therefore, as soon as this capability is available from inverter vendors and supported by industry standards and test protocols, the Companies will request a change to inverter specifications for Hawai'i to require incorporation of these features on all new DG installations. To provide incentives for curtailment, a rate to compensate DG owners will be needed (refer to Section 5 for a discussion of this topic).

#### 4.2.5 Advanced Inverter Issues and Recommendations for the Companies

A primary circuit-level issue facing the Companies today is the potential for TrOV events when a substation breaker opens. This occurs because the inverters currently installed throughout the system do not trip off immediately when there is a system loss of power; therefore, they remain connected and trip off at different times. The solution for this issue is to install fast-trip inverters. Currently, the Companies are working with inverter manufacturers to install equipment with specifications for faster tripping. However, in parallel, the industry is working to develop specifications for this function, because it

---

<sup>33</sup> Ibid.

was an issue not covered by the SIWG. Until specifications and testing are complete, the Companies will require an instantaneous one-cycle, high-voltage trip requirement (a stipulation requesting this new level will be developed) as a way to mitigate the risk of TrOVs.

Another issue is frequency ride-through thresholds. In the past, the Companies used the IEEE 1547-2003 threshold standard as the frequency trip setting. As such, most inverters ceased to support the distribution system when grid frequency exceeded the range of 59.3 Hz- 60.5Hz. Consequently, a significant amount of load and generation dropped offline as a result of the frequency event. To address this issue, Rule 14H was modified in 2011 to expand the under frequency trip point setting to 57 Hz. More recently, a proposed change to Rule14H will be filed to enable an expansion of the upper frequency trip limit to 63 Hz to address the possible increase to frequency as the ratio between generation and load escalates. There are also ride-through (“must-stay connected”) requirements at 57 Hz and 63 Hz that the Companies will propose to help maintain grid stability during system recovery in the upcoming filing.<sup>34</sup>

The Companies are also experiencing excess generation capacity that is producing large amounts of backfeed energy onto the grid from DG systems. Therefore, the Companies recommend that they eventually be provided with the capability to control DG output on a systemwide basis and possibly, on a circuit-wide basis. This will require two-way communications and load management applications. Until then, the Companies must carefully manage the amount of new DG being installed.

#### 4.2.6 Advanced Inverter Roadmap

Many of the recommendations outlined above will require technologies or applications that will need standards to be developed and/or approved before use. Therefore, when such technologies or applications become commercially available, the Companies will be dependent on when new standards are written, testing programs are established, and/or rules (e.g., Rule 14H) are modified to incorporate them. **Figure 4-8** summarizes the expected availability dates for smart inverter features, based on the CPUC SIWG plans.

---

<sup>34</sup> Please see the following for detailed documentation on these recommendations: Stipulations filed May 28, 2014, and June 12, 2014, regarding RSWG PV Sub-Group Work Products Pursuant to the PUC Order No. 32053.

## 4. Advanced DER Technology Utilization Plan (ADERTUP)

### 4.3 Distributed Storage

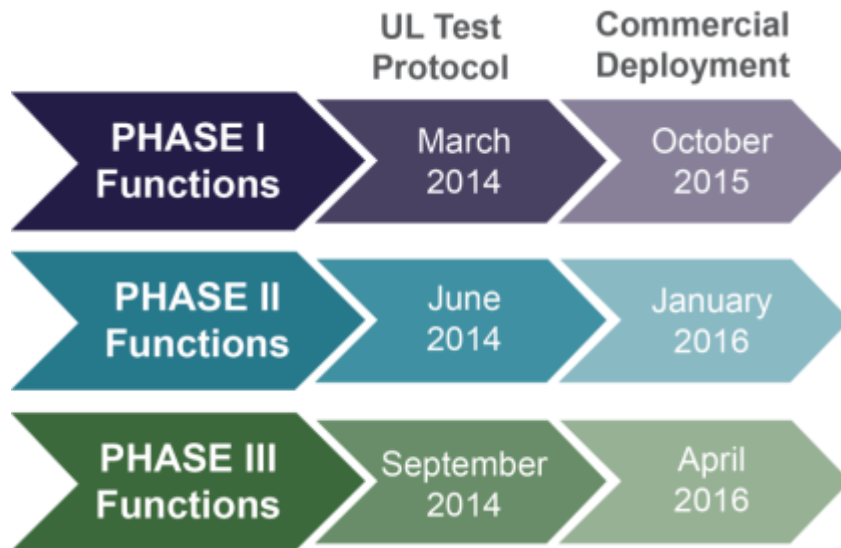

Figure 4-8. Smart Inverter Feature Availability from SIWG

The Companies are inclined to require full standards support, including testing and certification programs, before requiring new features to be present in inverters used in the local market. However, when there is a compelling need (as seen with the current frequency ride-through requirements), the Companies may require adoption before all standards, testing, and certification methods are in place. In this case, the Companies may request the inverter vendors to self-certify their equipment, with oversight provided by the utility.

Retrofitting of inverters to support new configurations or capabilities is likely to be complex and expensive and is to be avoided, except when critically needed (which is the case with frequency ride-through). To avoid retrofit issues, the Companies will encourage equipment vendors to provide advanced inverter capabilities as soon as feasible, whether required by regulation or by good practice.

---

## 4.3 DISTRIBUTED STORAGE

### 4.3.1 Distributed Storage Overview

In Order 32053, the Commission directs the Companies to develop and file a plan to use energy storage resources on the islands of Oahu, Hawai'i, and Molokai to address steady-state frequency control and dynamic stability requirements, as well as to mitigate other renewable energy integration challenges. These plans are to be part of the

Companies' respective PSIPs.<sup>35</sup> The Commission also directed the Companies to include information on distributed energy storage strategies and technologies within the DGIP.

The Companies recognize their responsibility to maintain safety and reliability of the electric grid systems and acknowledge that strategic initiatives to diversify the islands' resource mix, modernize the grid, and reform regulations and policies must be planned and executed in a cohesive, integrated manner.

Energy storage is expected to be a key component of the Companies' revised business strategy, given the technology's ability to provide grid services at all levels of the grid system. The Companies view energy storage as part of a portfolio of potential resources that can be used to increase grid flexibility, operability, and reliability in a rapidly changing operating environment.

The Companies' energy storage plan will include the following activities:

- Implement energy storage under a programmatic approach with a broad portfolio of assets consisting of utility-scale and customer-sited systems.
- Assess and implement an energy storage program for deployment and operation of energy storage assets that consider reliability, public policy, and customer interests.
- Collaborate with stakeholders and leverage external resources when available. The Companies will seek collaborative opportunities to develop energy storage solutions, including on the customer side of the meter. The Companies also will consider external participation in energy storage solutions where it makes operational and financial sense.
- Seek opportunities for collaboration with external entities to leverage labor, expertise, and funding, thus offsetting some of the technical and financial risks of unproven technologies or applications.

The Companies will evaluate and implement energy storage technologies and applications from two perspectives, as follows:

- **Utility Perspective** – Evaluate energy storage in parallel with other resource options, such as new types of generation, modified operations of existing generating units, advanced planning and operational tools, smart-grid and micro-grid technologies, and demand response programs.
- **Customer Perspective** – Explore ways to use energy storage to provide a broader range of services for customers, including utilization of energy storage within micro-grid environments, demand response, and thermal storage (e.g., grid interactive water

---

<sup>35</sup> Instituting a Proceeding to Investigate the Implementation of Reliability Standards for Hawaiian Electric Company, Inc., Hawaii Electric Light Company, Inc., and Maui Electric Company, Limited., Docket No.2011-0206, Order 32053, April 2014, 107.



## 4. Advanced DER Technology Utilization Plan (ADERTUP)

### 4.3 Distributed Storage

heating and ice storage). This perspective also includes the potential to incorporate customer-owned energy storage as a grid resource.

Energy storage is potentially the most impactful technology that could allow higher levels of penetration by solar PV generation in the near- and mid-term timeframes. The Companies will determine if these energy storage assets are deployed on the utility side of the meter and/or on the customer side of the meter. Encouraging customers with PV systems to charge batteries and store their excess energy during the day at the point of generation and to discharge during the peak demand period (evenings) may partially address the utility systems' excess energy during peak PV generation.

#### 4.3.2 Customer-Owned Distributed Energy Storage

Customer-owned Distributed Energy Storage Systems (DESS) can be installed at any home where DG is installed. The storage would be programmed and owned by the customer and would be dedicated to the customer's premises (see **Figure 4-9**). There would be two options for a customer to install energy storage—exporting mode and non-exporting mode.

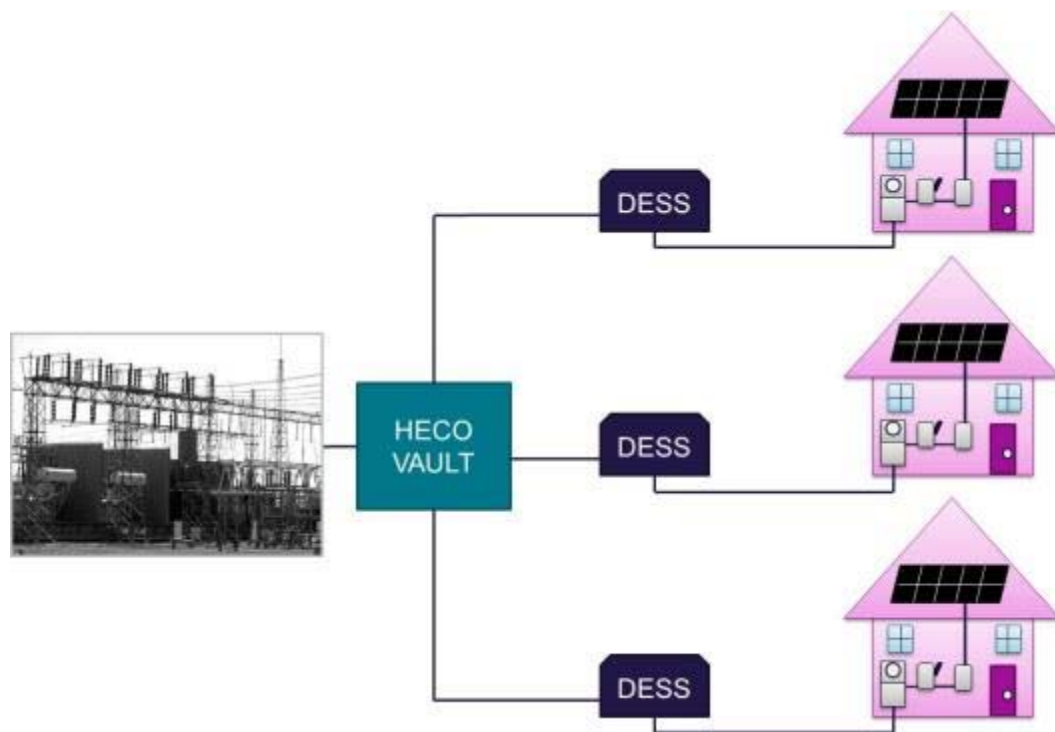

Figure 4-9. Configurations—Scenario 1: Residential DESS

Customer-owned DESS has advantages for the customer and the utility. If the storage is sized correctly, the storage can result in a lower impact on the overall grid, especially for the non-exporting solution. If properly created, the energy storage can help stabilize the overall power output to the grid, thereby reducing generation variability.

The predominant form of customer-owned storage will be battery energy storage. Lead-acid batteries are the most cost-effective solution today, but lithium-ion and other chemistries hold the promise of better density and longevity and are predicted to become significantly less expensive in coming years. An alternate form of storage is thermal storage, primarily through water heaters, but this is only a supplementary source used to deal with small amounts of excess energy, not for primary power applications.

The economics that promote customer-owned storage will be created by reformed rates, with the power export and import price differential establishing the incentive for a DESS. The value of DESS depends on its total charge and discharge cycles. When the energy stored and effective cycles create an equivalent purchase price lower than that of purchasing power from the utility, a DESS will become an attractive consumer option. If NEM rates remain the same with no differential in export and import pricing, DESS adoption will be restricted because of the market economic conditions.

As more utility control is incorporated, customer-side storage will provide a means for curtailing inverter output. In a future modern grid, full interaction among the utility, the inverter, and the storage system will create a highly adaptive grid that is responsive to changes in generation and load. Customer-side storage with utility control also can provide ancillary services, such as frequency and voltage regulation, load shifting, and spinning reserve capacity. A specific rate structure would need to be developed for customers who participate in this type of program to compensate customers for reduction in battery life from utility usage of the customer-side storage and to provide incentives for adoption. Some form of bilateral agreement also may be necessary to provide the structure under which customer and utility obligations are laid out and agreed to. Items that would need to be considered include customer system availability, information security, operating parameters, and liquidated damages.

Industry research indicates that customer-owned storage will become prevalent in coming years, driven by economics. The differential between export and import rates from the utility will create a demand to simply store the power locally. If the cost of energy storage decreases as predicted, it will make economic sense for customers to increase their use of storage. If this trend is combined with the utility's desire to limit energy export, and if the utility provides incentives through pricing for non-export, the number of customer-owned energy storage systems will increase dramatically. It is the Companies' point of view that this will be a likely form of energy storage in the foreseeable future and that it will be driven by market forces and customer choice.

### 4.3.3 Utility-Owned Distributed Energy Storage

DESS owned and operated by the utility can be beneficial in leveling the variability of renewables while providing time-shift capabilities to supplement generation. Siting for



## 4. Advanced DER Technology Utilization Plan (ADERTUP)

### 4.3 Distributed Storage

utility DESS can be on or near a substation or can be on or near customer premises (see Figure 4-10 and Figure 4-11).

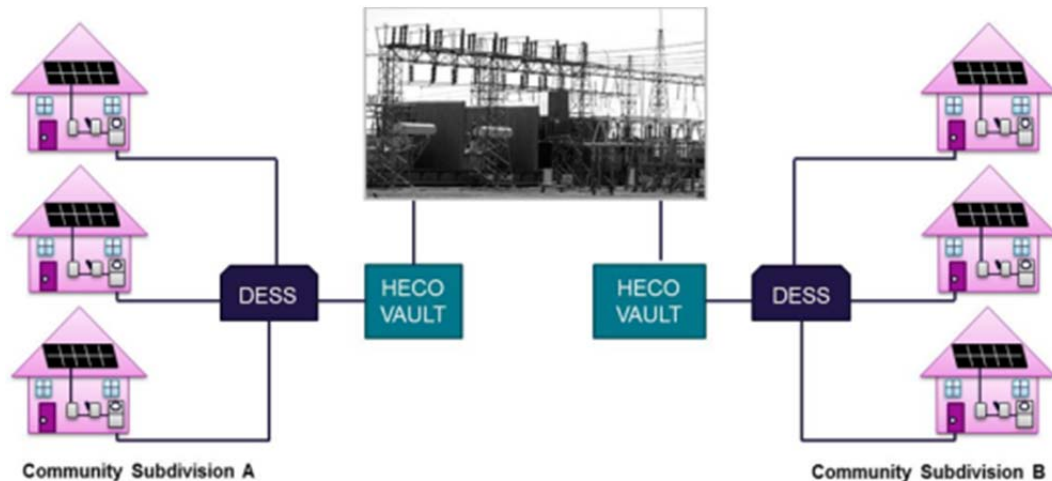

Figure 4-10. DESS Near-Premises

DESS can be installed in a neighborhood where several households and PV systems can use them, while they remain owned by the utility. The advantage of this siting is that power is held close to the neighborhood, and the footprint can be relatively small. The disadvantage of this solution is that it requires multiple sites and that it would be difficult to set up distributed controls, although the latter disadvantage may not be an issue in the future with improved wireless communications. Given the limits on storage capacity in neighborhoods because of space restrictions, distributing storage would not relieve circuit congestion, because the battery could become fully charged and no longer provide enough load to limit power output to the grid.

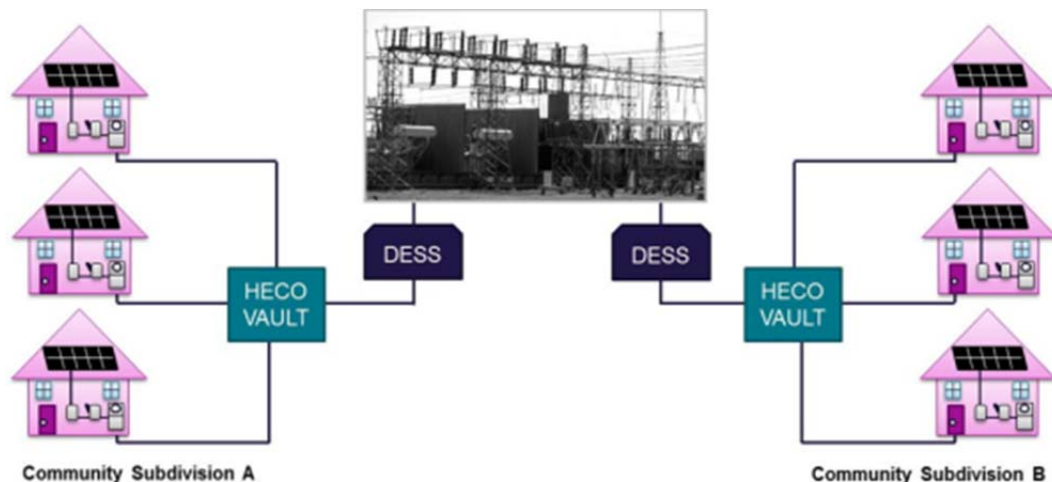

Figure 4-11. Substation DESS

DESS installed on or near a substation has multiple advantages over a more widely spaced DESS solution. A single large DESS can provide voltage stabilization in reaction

to renewables' intermittency, while also providing significant time-shift storage capabilities. Being near the substation, it can take advantage of connectivity to an entire circuit and provide the services at a much more economical level because of size and scale. Also, if near the substation, the DESS can access high-speed control networks, enabling it to become a much more integral component in balancing load and control across the entire circuit.

Substation DESS does not reduce circuit- and service-level congestion, because power must get to the DESS from the DG. However, DESS located near the substation can be used to reduce the need for substation transformer upgrades because the DESS can be used with switching to offset transformer loading during peaks. Substation transformer sizing is normally limited to 50% of peak backfeed in the presence of DG because it must be capable of handling two circuits during contingency operations. A DESS can reduce these peak loads and, combined with intelligence in switching, can be used to ensure total transformer loading can be limited, at least for long enough to allow curtailment. (This is a long-term capability, because the controls and curtailment needed to enable it are not currently available.)

DESS located near a substation will not increase resiliency because the substation and circuits are not designed to be operated as an island. In the long- to far-term, it is conceivable that substation DESS will be configured as a stand-alone microgrid, allowing short-duration event ride-through. This configuration is already emerging in select customer sites, such as at military bases.

While a utility DESS provides minor circuit improvements, the primary value of DESS would be in time-shifting renewable resources. At this time, the benefit of this function does not justify the high cost of the storage. As the cost comes down and as the need increases due to higher DG penetration, it may become economical to deploy large amounts of utility DESS (e.g. a fleet of distributed storage systems may have the capability to provide immediate autonomous frequency support).

#### 4.3.4 Grid Energy Storage/Contingency Reserves

The Companies will develop energy storage resources on the islands of Oahu, Hawai'i, Maui, and Molokai to meet steady-state frequency control and dynamic stability requirements, as well as to mitigate other renewable energy integration challenges. These plans are to be part of the Companies' respective PSIPs. The Companies recognize their responsibility to maintain safety and reliability of the electric grid systems and acknowledge that strategic initiatives to diversify the islands' resource mix, modernize the grid, and reform regulations and policies must be planned and executed in a cohesive, integrated manner.

## 4. Advanced DER Technology Utilization Plan (ADERTUP)

### 4.3 Distributed Storage

Energy storage is expected to be a key component of the Companies' revised business strategy, given the technology's ability to provide grid services at all levels of the grid system. The Companies view energy storage as part of a portfolio of potential resources that can be used to increase grid flexibility, operability, and reliability in a rapidly changing operating environment.

Energy storage will be used to provide frequency and stability support (contingency reserves) in the near term. This storage remains to be sited, but is likely to be distributed to some extent. Contingency reserves must maintain a minimum storage capacity, but capacity above that minimum can be used for time-shifting applications (i.e., taking excess energy from the grid at times; returning the energy to the grid, when needed). In the time-shift application, the energy storage solution can be used to counteract the variability of renewable storage and to provide better overall system control. While time-shifting capability is beneficial to the grid, at this time, it is not a cost-effective option. The contingency solution will be sized with no excess energy storage at this time, but the option to expand it will be provided to make it easy to add time-shift abilities, if and when they become economical.

#### 4.3.5 Rule 14H Modifications to Incorporate Distributed Storage

Incorporating distributed storage applications as part of a customer DG solution presents its own set of issues. The overarching theme is that all sources of energy must be treated equitably, whether the source is storage or a generator. Furthermore, the same interconnection requirements must apply for all potential energy sources. These issues required Hawaiian Electric to review its interconnection policies incorporated into Rule 14H. On June 2, 2014, Hawaiian Electric filed an application with the Commission to modify Rule 14H to incorporate language to address, among other things, interconnecting distributed storage and registering non-exporting DG units.<sup>36</sup> This application presented examples of distributed generation and storage scenarios, and discussed how they might be affected by the proposed modifications, as shown in **Table 4-4**.

---

<sup>36</sup> Docket 2014-0130, Hawaiian Electric Company, Inc., Hawaii Electric Light Company, Inc., Maui Electric Company, LTD., for Approval of Modify Rule 14H-Interconnection of Distributed Generating Facilities Operating in Parallel with the Companies' Electric System, Filed June 2, 2014.

4. Advanced DER Technology Utilization Plan (ADERTUP)

4.3 Distributed Storage

Scenario	Subject to 14H Appendix III, Section 2.b Review?	Required to Register under 14H Appendix II-B	Load Balance or Excess Generation Opportunity?
Scenario No. 1: Isolated Distributed Generating Facilities Supplying DC Loads	No	No	No
Scenario No. 2: Isolated Distributed Generating Facilities Supplying AC Loads	No	No	No
Scenario No. 3: Interconnected Distributed Generating Facilities with No Potential to Operate in Parallel	No	Yes	Load Balance
Scenario No. 4: Interconnected Distributed Generating Facilities with Potential to Operate in Parallel	Screen 4: Yes Screens 2,3: Yes, unless design shows no parallel operations	Yes	Load Balance
Scenario No. 5: Interconnected Distributed Generating Facilities with Potential to Operate in Parallel (Automatic Transfer Switch: “Make-Before-Break”)	Screen 4: Yes Screens 2,3: Yes, unless design shows no parallel operations	No	Load Balance
Scenario No. 6: Interconnected Distributed Generating Facilities with Potential to Operate in Parallel (Inverter-Based Reverse Power Protection)	Screen 4: Yes Screens 2,3: Yes, unless design shows no parallel operations	No	Load Balance
Scenario No. 7: Interconnected Distributed Generating Facilities Designed to Operate in Parallel	Yes, Screen 2	No	Load Balance, Excess Generation
Scenario No. 8: Interconnected Distributed Generating Facilities Designed to Operate in Parallel (Addition of Energy Storage System to Existing PV System)	Yes, Screen 2	No	Load Balance, Excess Generation
Scenario No. 9: Interconnected Distributed Generating Facilities Designed to Operate in Parallel (Expansion of Existing PV Capacity and Addition of Energy Storage System)	Yes, Screens 2,3,4	No	Load Balance, Excess Generation

Load balance: This is an opportunity for the utility to charge the customer’s batteries.

Excess Generation: This is an opportunity for the customer to supply the utility grid with power.

Table 4-4. Storage Scenario

## 4. Advanced DER Technology Utilization Plan (ADERTUP)

### 4.3 Distributed Storage

#### 4.3.6 Distributed Storage Implementation Plan

Distributed storage is a tool that potentially can be used to integrate with PV resources. The design must consider the specific issues to be solved, such as which system-level issues energy storage will address, or which level of the infrastructure the economics and effectiveness of energy storage are superior (i.e., should the storage be located at the bulk system level, or are distributed resources more effective?). These answers will depend on the use of the stored power.

Caution is warranted in making claims for providing backup power services for islands during widespread outages. This greatly increases complexity and will introduce new sizing requirements to serve all loads rather than the size being derived to meet the other intended uses for mitigation of distributed solar impacts.

The current economics of utility-owned DESS do not justify its widespread deployment. As storage technologies mature, the costs of DESS will decrease. To prepare for such a situation, the Companies have conducted many battery energy storage system (BESS) pilots, as shown in **Table 4-5**. To continue to foster innovation and build internal operating experience through energy storage research and development activities, the Companies will continue to seek out demonstration projects to evaluate distributed energy technologies, applications, and strategies that support the implementation of clean energy solutions, including the integration of higher amounts of distributed renewable energy. The Companies also will engage in research, development, and demonstration (RD&D) activities for applications that are novel or not yet proven commercially viable, including the design and implementation of energy storage and advanced inverter demonstration projects to collect the key performance and cost information needed to build internal expertise and experience. When BESS becomes cost effective, the utility must be ready for early deployment.

#### 4. Advanced DER Technology Utilization Plan (ADERTUP)

##### 4.3 Distributed Storage

Company Project	Size	Manufacturer/ Technology	Status/Time Frame	Grid Service Requirements
Hawai'i Electric Light Hawi BESS	1 MW/250 kWh	Altairnano Lithium Titanate	Installed 2012-2017	Power smoothing and frequency support for Hawi Wind Farm
CIP BESS Demo	1 MW/250 kWh	Altairnano Lithium Titanate	Planned 2014-2017	Frequency and voltage support, power smoothing
Maui Electric Smart Grid BESS at Wailea Substation	1 MW/1 MWh	A123 Lithium ion Nanophosphate	Installed	Peak shaving and voltage support
Hawai'i Electric Light Power Conditioner	2 Units: 100 kW/248 kWh	Saft Lithium Ion	Installed	Voltage and frequency stabilization
Molokai BESS	2 MW/397 kWh	Altairnano Lithium Titanate	Planned 2015-2020	Frequency support contingency reserve
Greensmith BESS and Ancillary Services Test	5 kW/20 kWh	Lithium Yttrium Iron Phosphate	Installed 2010-2015	Testing PV intermittency smoothing, load shaving, voltage regulation, and frequency response capabilities
Hawaiian Electric PV and BESS EV Carport	6 kW/20 kWh	ThunderSky/Greensmith Lithium Ion	Installed	EV charging
<b>Third Party/IPP Projects</b>				
La Ola PV BESS	1.125 MW/0.5 MWh	Xtreme Power Advanced Lead Acid	Installed	
Kaheawa I BESS	1.5 MW/1 MWh	Xtreme Power Advanced Lead Acid	Installed	
Kaheawa II BESS	10 MW/20 MWh	Xtreme Power Advanced Lead Acid	Installed	
Auwahi Wind BESS	11 MW/4.4 MWh	A123 Lithium Ion	Installed	

Table 4-5. Advanced Technology Development Program Summary



## 4.4 INTEGRATED DEMAND RESPONSE PORTFOLIO PLAN

### 4.4.1 Background

The Commission recently issued Order 32054 that set forth guidelines for the continued operation and expansion of demand response programs and ordered the Companies to respond to Commission directives around these guidelines.<sup>37</sup> This section contains information from the Companies' July 28, 2014, filing to the Commission with respect to its Integrated Demand Response Portfolio Plan (IDRPP).

From program design, implementation, and operation, the Company's IDRPP will be managed according to the following guiding principles:

- Adheres to mission statement: "The Hawaiian Electric Companies will aggressively pursue all demand response program that best serve the interest of our customer across all five island grids."
- Designed to meet the current and future needs of the system, including capacity, ancillary services, and reliability requirements. Programs to be pursued will include DLC and/or incentive-based programs, time-of-use-based pricing programs, and programs using customer-provided and customer-sited equipment.
- The market is allowed to determine the success and constitution of the respective DR programs. In recognition of the challenges the Companies will face with the increasing penetration of DG programs, the IDRPP will seek to encompass resources that can be turned up and down, as well as off and on, and will meet ancillary service requirements and capacity deferral objectives.

The Companies followed three steps in designing the IDRPP, as follows:

**Define Grid Service Requirements** – As requirements were developed, it became apparent that in some cases there were distinct differences between requirements that may be used with a mainland utility versus Hawaiian Electric, particularly as they pertain to response speed and duration. **Table 4-6** summarizes the grid service requirements.

---

<sup>37</sup> Docket No. 2007-0341, Order No. 32054-Policy Statement and Order Regarding Demand Response Programs, filed on April 28, 2014.

4. Advanced DER Technology Utilization Plan (ADERTUP)  
4.4 Integrated Demand Response Portfolio Plan

Grid Service Requirements	Response Speed* (Mainland)	Response Speed* (Hawaii)	Response Duration	Potential for DR?
<b>Capacity</b>				
<b>Capacity</b> Used to meet demand plus reserve margin; supplied by on-line and off-line resources, including interruptible load	Minutes	scheduled in advance by system operator	If called, must be available for at least 3 hours	✓
<b>Ancillary Services</b>				
<b>Contingency Reserve**</b> Reserves to replace the sudden loss of the single largest on-line generator; supplied from online generation, storage or DR	Seconds to <10 min	Within 7 cycles of contingency event	Up to 2 hours	✓
<b>Regulating Reserve</b> Maintain system frequency; supplied from on-line capacity that is not loaded	<1 min	2 seconds, controllable within a resolution of 0.1 MW	Up to 30 min	✓
<b>Non-Spinning Reserve</b> Used to restore regulating reserves and contingency reserves; supplied by off-line fast start resources or DR	10-30 min	<30 min	2 hours	✓
<b>Non-AGC Ramping</b> Resources that can be available prior to quick start generation and can add to system ramping capability	N/A	<2 min	Up to 2 hours	✓
<b>Black Start Capability</b> The ability of a generating unit to start without system support	N/A	<10 min	Duration of system restoration time	✗
<b>Inertial Response</b> Local (i.e. at a generator) response to a change in frequency; supplied by rotational mass of generators, or power electronics of inverter-based resources	N/A	2-3 seconds	2-3 seconds	✗
<b>Other</b>				
<b>Accelerated Energy Delivery***</b> Shifting the demand for energy from high demand evening peak periods to lower demand midday periods, or higher demand morning periods to lower demand overnight periods	N/A	N/A	N/A	✓

\* Response speed refers to the time needed to "dispatch" a resource, automatically or manually, once it is known it is needed.

\*\* Contingency reserves that cannot meet the 7 cycle operation requirement are not fast enough to serve as primary protection resources (e.g. spinning reserves), but may be able to meet the contingency reserve requirements consistent with the "kicker block" of secondary resources.

\*\*\* Accelerated Energy Delivery is not an ancillary service product of the Hawaii system, but will help meet the need to reduce peak loads and especially to increase overnight and midday demand.

Table 4-6. DR Grid Service Requirements

**Identify and assess end uses that can be used to satisfy grid requirements** – This would include space cooling, residential water heating, residential cooling, and so on. The Companies used an approach from Lawrence Berkeley National Laboratory to help identify end uses by determining whether they fit one or more of the following characteristics: a) load sheddability; b) resource controllability, or c) customer acceptability.<sup>38</sup> **Figure 4-12** illustrates this process.

<sup>38</sup> Grid Integration of Aggregated Demand Response, Lawrence Berkeley National Laboratory, 2013

## 4. Advanced DER Technology Utilization Plan (ADERTUP)

### 4.4 Integrated Demand Response Portfolio Plan

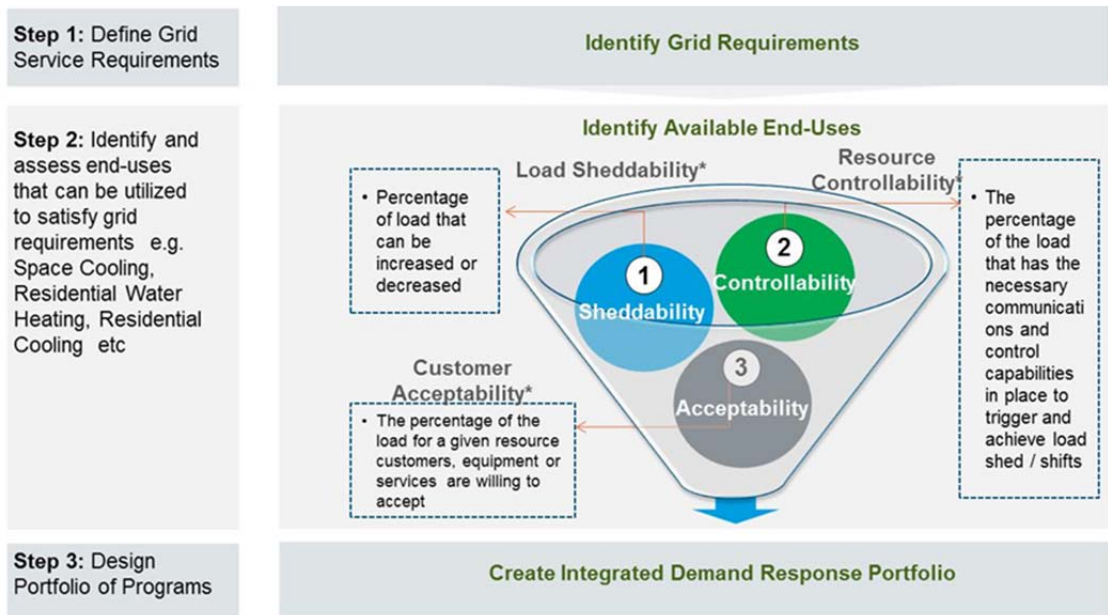

Figure 4-12. End-Use Identification Process

**Design Portfolio of Programs** – Create programs that integrate end uses that exhibit the characteristics required to meet the Companies’ grid requirements.

#### 4.4.2 Current State of the Companies’ Programs

The Companies are implementing four programs in their current portfolio: Residential Direct Load Control (RDLC), Commercial and Industrial Direct Load Control (CIDLC), Fast Demand Response (DR)–Hawaiian Electric, and Fast DR–Maui Electric. **Table 4-7** provides a summary of the program attributes for the existing programs.

4. Advanced DER Technology Utilization Plan (ADERTUP)  
4.4 Integrated Demand Response Portfolio Plan

	RDLC	CIDLC	Fast DR (Hawaiian Electric)	Fast DR (Maui Electric)
<b>Target Customers</b>	• Residential	• Commercial and Industrial	• Commercial and Industrial	• Commercial and Industrial
<b>Participation</b> (load impacts in MW are shown at customer level)	• 32,350 WH and 3,750 AC as end of 2013 • 14.8 MW	• 38 large C&I, and 160 small and medium business as end of 2013 • 12.8 MW	• 38 enrolled customers as of March 2014 • 6.1 MW	• 4 enrolled customers as of March 2014 • 0.2 MW
<b>Participation Conditions</b>	• Electric water heater • Central air conditioning • Load control receiver or PCT	• Large C&I with non-critical or generator backed loads, with minimum 50 kW of control • Small C&I with electric water heating and central air conditioning	• Min 50kW controlled • 10min or less response • Max 2 hr duration	• Min 50kW controlled • 10min or less response • Max 2 hr duration
<b>Incentives for Participation</b>	• \$3/WH-mo • \$5/AC-mo • No variable payment required per event	CIDLC: • \$10/kW-mo for auto load shed • \$5/kW-mo + \$0.5/kWh for manual dispatch SBDLC: • \$5/WH-mo • \$5/AC-mo • \$8/other-mo	• Tiered incentive ranging from \$5/kW-mo to \$10/kW-mo • Also technology incentive ranging from \$300/kW-yr for semi-auto control, to \$600/kW-yr for auto load control	• \$5/kW-mo and \$0.5/kWh after the first 15 hours of curtailment
<b>Availability</b>	• 24 hrs/day, 365 days/yr • No notification • Under-frequency, reliability and economic dispatch	• 24 hrs/day, 365 days/yr • 1-hr advance notice • Up to 300 hrs/yr • Under-frequency and reliability dispatch	• For \$5/kW-mo, 40 hrs/yr, up to 40 events • For \$10/kW-mo, 80 hrs/yr, up to 80 events	• 40 hrs/yr, up to 40 events
<b>Technology</b>	• One-way Paging Load Control Receiver	• One-way Paging Load Control Receiver	• Two-way comms • AutoDR / Aggregator	• Two-way comms • AutoDR /Aggregator

Table 4-7. Attributes of Existing DR Programs

These programs were also compared against key grid services requirements that must be met in the future. **Table 4-8** shows that existing programs cover only some requirements. This gap analysis provided the information needed to develop the programs included in the IDRPP programs.

Grid Service Requirements	Current Demand Response Programs			
	RDLC	CIDLC	Fast DR (Hawaiian Electric)	Fast DR (Maui Electric)
Capacity	✓	✓	✓	✓
Regulating Reserve	✗	✗	✗	✗
Contingency Reserve*	✓	✓	✗	✗
Non-Spinning Reserve	✓	✗	✓	✓
Non-AGC Ramping	✓	✗	✗	✗
Accelerated Energy Delivery	✗	✗	✗	✗

\* Under-frequency response provided by RDLC and CIDLC can provide system protection but is not fast enough to be substituted for spinning reserves under the Companies' contingency reserve requirement.

Table 4-8. Assessment of Existing Programs Relative to Grid Requirements

## 4. Advanced DER Technology Utilization Plan (ADERTUP)

### 4.4 Integrated Demand Response Portfolio Plan

#### 4.4.3 Planned Programs

The IDRPP plan incorporates additional programs that reflect the need to meet the grid services requirements in the future, as summarized above. The following programs are included in the portfolio:

- Residential and Small Business DLC
- Residential and Small Business Flexible
- Commercial and Industrial (C&I) DLC
- C&I Flexible
- Customer Generation
- Municipal and C&I Water Pumping Control
- Dynamic and Critical Peak Pricing.

**Table 4-9** provides additional details on these programs.

#### 4. Advanced DER Technology Utilization Plan (ADERTUP)

##### 4.4 Integrated Demand Response Portfolio Plan

Item	Residential and Small Business		Commercial and Industrial			Muni/ C&I	
	<i>DLC</i>	<i>Flexible</i>	<i>DLC</i>	<i>Flexible</i>	<i>Customer Generation</i>	<i>Water Pumping Control</i>	<i>Dynamic/Critical Peak Pricing</i>
Program Compensation	Availability Payment (\$/kW-yr)	Availability Payment (\$/kW-yr)	Availability Payment (\$/kW-yr) and Energy Payments (\$/kWh)	Availability Payment (\$/kW-yr)	Availability Payment (\$/kW-yr) and Energy Payments (\$/kWh)	Availability Payment (\$/kW-yr)	Customers are compensated indirectly through lower prices during specified hours of the day
Performance Measurement	Difference between pre- and post-event load	Difference between pre- and post-event load	Difference between pre- and post-event load	Difference between pre- and post-event load	Difference between pre- and post-event load	Difference between pre- and post-event load	N/A
Cost per Event	None	None	\$0.50/kWh	None	\$0.50/kwh	None	N/A
Program Availability	Unlimited	Continuous	Up to 300 hrs per year	Continuous	100 hrs per year	Continuous	N/A
Response Speed	Range: < 2 min to < 30 min	For AGC, within 2 secs of receiving signal	Concurrent with event	For Regulating Reserve, within 2 secs of receiving signal; for Non-AGC, < 2 min	Minutes	For Regulating Reserve, within 2 secs of receiving signal; for Non-AGC, < 2 min	Minutes or hours
Grid Service Requirements	Capacity, Non-AGC Ramping, Non-Spinning Reserve	Regulating Reserve, Accelerated Energy Delivery	Capacity	Regulating Reserve, Non-AGC Ramping	Capacity	Regulating Reserve, Non-AGC Ramping	Capacity, Accelerated Energy Delivery
Program Penalties	Loss of incentive payments and/or	Loss of incentive payments and/or	Loss of incentive payments	Loss of incentive payments and/or	Loss of incentive payments and/or	Loss of incentive payments and/or	None

**4. Advanced DER Technology Utilization Plan (ADERTUP)**

**4.4 Integrated Demand Response Portfolio Plan**

Item	Residential and Small Business		Commercial and Industrial			Muni/ C&I	
	<i>DLC</i>	<i>Flexible</i>	<i>DLC</i>	<i>Flexible</i>	<i>Customer Generation</i>	<i>Water Pumping Control</i>	<i>Dynamic/Critical Peak Pricing</i>
	system tariff penalty payments	system tariff penalty payments	and/or system tariff penalty payments	system tariff penalty payments	system tariff penalty payments	system tariff penalty payments	
Program Administration	Utility and/or Third-Party DR Provider	Utility and/or Third-Party DR Provider	Utility and/or Third-Party DR Provider	Utility and/or Third-Party DR Provider	Utility	Utility and/or Third-Party DR Provider	Utility
Potential Load Resources	Electric Water Heating, Central AC	GIWH, Central AC	Non-Critical or Generator-Backed Customer Load	Non-Critical or Generator-Backed Customer Load	Customer-Sited Diesel Generators	Municipal Pumping, Wastewater Pumping	Unspecified Customer Load
Technical Requirements	Two-Way Comms, Zigbee Protocol, Demand Response Management System (DRMS)	Two-Way Comms, AutoDR, Variable-Capacity Water Heaters, Load Control Module Aggregation	Load Control Switches, PCTs, Real-Time Performance Transparency, Two-Way Comms, AutoDR	Real-Time Performance Transparency, Two-Way Comms, AutoDR	Real-Time Performance Transparency, Two-Way Comms AutoDR	Variable-Speed Devices, Real-Time Performance Transparency, Two-Way Comms, AutoDR	Real-Time Performance Transparency, Two-Way Comms, AutoDR

Table 4-9. IDRPP Planned Programs

The demand response programs above will be priced through a two-step process. The first step will be to establish the value of the program to the Companies' system. This would be based on avoided cost, which is the cost of meeting a given grid requirement without DR. The maximum price paid for the resource would be the avoided costs less program administrative costs. The avoided costs will be calculated and filed under protective order to avoid disrupting the competitive process. The avoided costs will also change over time with fuel costs, installed cost of substitutes, and other factors. Avoided cost considerations will be based on the following factors:

- **Capacity**— The cost of new capacity deferral, likely to be the per kW cost of a reciprocating or peaking unit.
- **Regulating reserve**— The cost of a frequency support energy storage device or the cost savings from reduced regulating reserve requirements, calculated using a production cost model.
- **Contingency reserve**— For Oahu, the fuel cost savings resulting from a reduction in the spinning reserve requirement commensurate with the DR resources assumed to meet contingency reserve requirements, as calculated using a production cost model. For Maui and Hawai'i, this would offset under frequency load shedding, producing a customer benefit, but not a readily calculated economic benefit.
- **Non AGC Ramping**— The fuel cost savings and maintenance savings resulting from deferring unit starts for a wind down-ramp. May offer an alternative to having to install additional fast-start capacity, in which case the evaluation could be similar to the capacity deferral.
- **Non-Spinning Reserve**— At present, the cost of maintaining existing resources that currently meet non-spinning reserves. For Oahu, this cost will be represented by the estimated operations and maintenance cost difference between Waiau 3&4 operating and on layup.
- **Advanced Energy Delivery**— The production cost savings incurred by shifting demand, as compared to production costs if demand were not shifted.

As part of the IDRPP, Hawaiian Electric developed DR potential estimates by program type, grid requirement, and island. **Table 4-10**, **Table 4-11**, and **Table 4-12** provide a consolidated DR market potential forecast by program type.



#### 4. Advanced DER Technology Utilization Plan (ADERTUP)

##### 4.4 Integrated Demand Response Portfolio Plan

<i>O'ahu</i>	<i>Grid Service Requirement</i>	<i>2014</i>	<i>2019</i>	<i>2024</i>	<i>2034</i>
RBDLC*	Capacity	10.0	30.4	33.3	33.3
	Contingency Reserve	0.0	0.0	0.0	0.0
	Non-AGC Ramping	10.0	30.4	33.3	33.3
	Non Spinning Reserve	10.0	30.4	33.3	33.3
R&B Flexible	Regulating Reserve	0.0	3.3	5.1	5.1
	Accelerated Energy Delivery	0.0	1.7	2.7	2.7
CIDLC	Capacity	10.0	23.8	25.4	25.4
	Contingency Reserve	0.0	0.0	0.0	0.0
C&I Flexible	Regulating Reserve	0.0	2.6	4.1	4.1
	Non-AGC Ramping	0.0	9.0	14.1	14.1
C&I Pumping	Regulating Reserve	0.0	1.2	1.9	1.9
Customer Generation	Capacity	0.0	5.0	5.0	5.0
	<b>Total Load Under Control**</b>	<b>26.0</b>	<b>70.2</b>	<b>82.4</b>	<b>82.4</b>

\* 2014 projection of 10 MW is based on the average load impact of the RDLC-WH program estimated for the evening hours of the 2013 events. No RDLC-AC event took place in 2013.

Table 4-10. Oahu Programs With Projections

4. Advanced DER Technology Utilization Plan (ADERTUP)  
4.4 Integrated Demand Response Portfolio Plan

<i>Hawai'i</i>	<i>Grid Service Requirement</i>	<i>2014</i>	<i>2019</i>	<i>2024</i>	<i>2034</i>
RBDLC	Capacity	0.0	4.9	6.0	6.0
	Contingency Reserve	0.0	0.0	0.0	0.0
	Non-AGC Ramping	0.0	4.9	6.0	6.0
	Non Spinning Reserve	0.0	4.9	6.0	6.0
R&B Flexible	Regulating Reserve	0.0	0.9	1.4	1.4
	Accelerated Energy Delivery	0.0	0.5	0.7	0.7
CIDLC	Capacity	0.0	1.8	2.2	2.2
	Contingency Reserve	0.0	0.0	0.0	0.0
C&I Flexible	Regulating Reserve	0.0	0.3	0.4	0.4
	Non-AGC Ramping	0.0	0.9	1.4	1.4
C&I Pumping	Regulating Reserve	0.0	0.1	0.2	0.2
Customer Generation	Capacity	0.0	3.0	3.0	3.0
	<b>Total Load Under Control*</b>	<b>0.0</b>	<b>11.1</b>	<b>13.6</b>	<b>13.6</b>

\* Total number reflects the sum of the potential obtained from each load resource used to calculate these projections (which is not equal to the sum of the potentials identified under each grid service requirement in the table because of program overlap and the ability of some end use resources to meet multiple grid service requirements).

Table 4-11. Hawai'i Programs with Projection

## 4. Advanced DER Technology Utilization Plan (ADERTUP)

### 4.4 Integrated Demand Response Portfolio Plan

<i>Maui</i>	<i>Grid Service Requirement</i>	<i>2014</i>	<i>2019</i>	<i>2024</i>	<i>2034</i>
RBDLC	Capacity	0.0	5.7	7.1	7.1
	Contingency Reserve	0.0	0.0	0.0	0.0
	Non-AGC Ramping	0.0	5.7	7.1	7.1
	Non Spinning Reserve	0.0	5.7	7.1	7.1
R&B Flexible	Regulating Reserve	0.0	0.7	1.1	1.1
	Accelerated Energy Delivery	0.0	0.4	0.6	0.6
CIDLC	Capacity	0.2	2.5	3.0	3.0
	Contingency Reserve	0.0	0.0	0.0	0.0
C&I Flexible	Regulating Reserve	0.0	0.4	0.6	0.6
	Non-AGC Ramping	0.0	1.3	2.1	2.1
C&I Pumping	Regulating Reserve	0.0	0.2	0.3	0.3
Customer Generation	Capacity	0.0	3.0	3.0	3.0
	<b>Total Load Under Control*</b>	<b>0.2</b>	<b>13.1</b>	<b>16.1</b>	<b>16.1</b>

\* Total number reflects the sum of the potential obtained from each load resource used to calculate these projections (which is not equal to the sum of the potentials identified under each grid service requirement in the table because of program overlap and the ability of some end use resources to meet multiple grid service requirements).

Table 4-12. Maui Programs with Projection

#### 4.4.4 IDRPP Roadmap and Implementation Plan

**Figure 4-13** provides an overview of the IDRPP roadmap. Two of the programs will require installation of an AMI system as a requirement of long-term operation.

**4. Advanced DER Technology Utilization Plan (ADERTUP)**  
**4.5 Electric Vehicles (EV) and Electric Vehicle Supply Equipment (EVSE)**

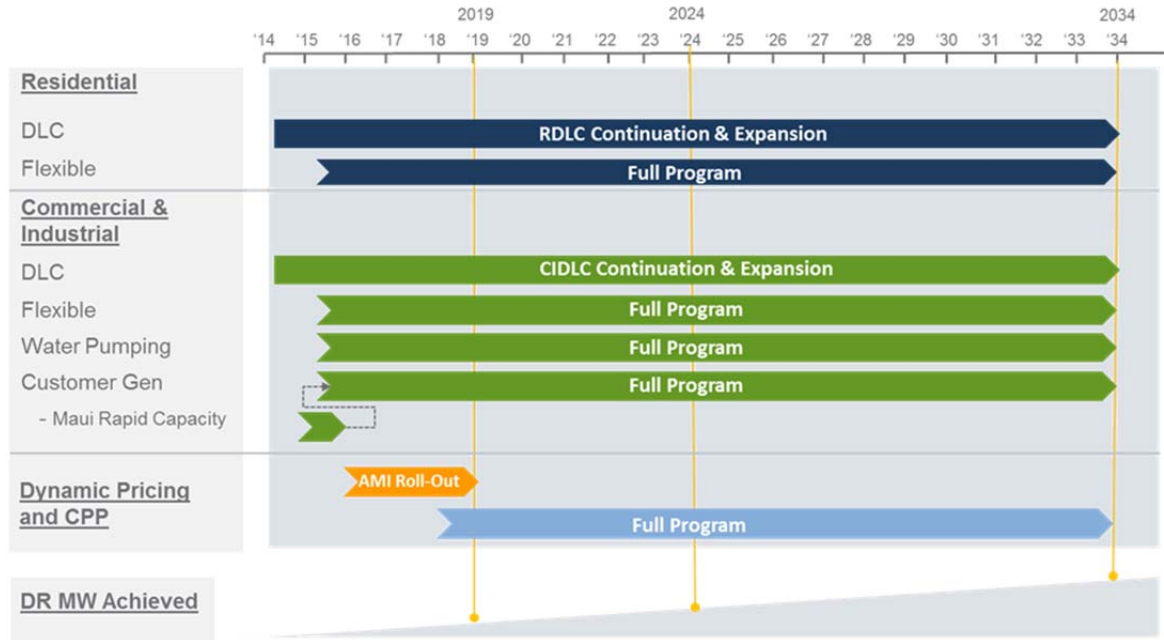

Figure 4-13. Integrated Demand Response Portfolio Roadmap

Implementation of the IDRPP roadmap will include regulatory, operational, and capability adjustments. Key implementation steps will include the following:

- Create island-specific implementation plans aligned with the overall IDRPP deployment time frame
- Implement regulatory reform (e.g., approval process, cost recovery, reporting)
- Conduct RFP processes for third-party vendors
- Establish contracting terms and establish program pricing
- Align demand response technical requirements with smart-grid roadmap submission
- Create centralized and third-party IDRPP operating model
- Align organizational structure with operating model.

## 4.5 ELECTRIC VEHICLES (EV) AND ELECTRIC VEHICLE SUPPLY EQUIPMENT (EVSE)

### 4.5.1 Overview

In October 2010, the Companies implemented a pilot EV rate program across their utility service territories. The program was open to the first 1,000 customers on Oahu, 300 customers on Maui County, and 300 customers on Hawai'i Island who owned highway-capable, four-wheel EVs with a battery capacity of no less than 4 kilowatt hours (kWh).

#### 4. Advanced DER Technology Utilization Plan (ADERTUP)

##### 4.5 Electric Vehicles (EV) and Electric Vehicle Supply Equipment (EVSE)

The pilot was to last 3 years, and all rates were based on time of use (TOU). The TOU options also included 1-meter and 2-meter options; the 2-meter option included an additional meter to be used exclusively for EV charging. There were residential- and commercial-class rates; in all cases, a discount rate was offered for charging during off-peak hours, and a premium rate was offered for charging during all other times of day. The EV pilot rates were developed to support EV adoption, encourage EV charging during the off-peak period to minimize grid reliability issues and create a positive EV customer experience. The EV industry is still in its infancy, with the potential for significant load growth that could adversely affect the Companies' grid reliability if left unmanaged. The potential also exists for load growth to play a role in remedying mid-day generation to load unbalance. In both cases, careful utility planning, design, and as-available technology utilization and implementation will determine how this load can be managed and optimized.

Since introduction of the EV pilot rates in 2010, renewable DG (RDG) (especially distributed solar DG) has increased significantly. EV charging loads are incremental loads to the grid. Being able to control and manage the EV charging load and match these loads with the power generated from RDG may provide opportunities for each to be complementary and help balance the supply and demand of power on the grid.

As part of a collaborative smart grid demonstration project with energy partners from the United States and Japan, the Companies installed an advanced EV charging management system with charging stations island-wide, allowing Maui Electric to actively manage electric vehicle charging to balance generation and load. An Electric Vehicle Energy Control Center (EVECC) monitors and controls a network of charging stations throughout the island of Maui. The EVECC also communicates with the network operation centers of the electric vehicle manufacturers to obtain system charging forecasts and to provide excess energy forecasts to allow the vehicles to utilize excess renewable energy when available. This demonstration project will continue through spring 2016. The project will also utilize smart inverters and load management for home volunteers on three circuits to evaluate the impacts to customer and distribution circuit.

### 4.5.2 EV Charging Opportunities

The increase in EV must be supported by an increase in charging infrastructure. The Companies realize this infrastructure not only supports EV adoption, but also provides an opportunity for long-term load management. Assisted only by conventional "wait and see" business practice, this infrastructure growth may be slow and disjointed. The Companies envision that fast charging will support adoption by extending EV range and by providing charging facilities to the population that may not have convenient charging infrastructure, such as condominium and apartment tenants. EV adoption is critical to

#### 4. Advanced DER Technology Utilization Plan (ADERTUP)

##### 4.5 Electric Vehicles (EV) and Electric Vehicle Supply Equipment (EVSE)

achieve a threshold of potential aggregate load that can be used to effectively manage grid services.

On July 4, 2013, the Companies began offering two new EV pilot rates effective through June 30, 2018.

Schedule EV-F provides a separately metered commercial rate for charging facilities up to 100 kW with no demand charge, in lieu of a higher kWh consumption charge. The objective is to support start-up charging facilities. The monthly billing charges are set to provide financial benefit over standard commercial demand services up to approximately 5,000 kWh per month, at which time these facilities may no longer necessarily be deemed a start-up facility.

Schedule EV-U allows the Companies to own and operate public DC fast-charging services. The Companies are allowed to operate a total of 25 charging accounts throughout their combined service territories.

Schedule EV-U allows the Companies to demonstrate and evaluate DC fast-charging technologies, such as demand response, which may alleviate grid demand. Currently, the CHAdeMO fast-charging specification does not support throttling the maximum charge rate during an active charge session. The Companies also may investigate the use of energy storage to alleviate grid demand for DC fast charging, as well as the viability and effectiveness of these and other potential technologies that will support grid services and meet EV customers' needs. Current plans under Schedule EV-U call for the Companies to deploy 8 DC Fast Chargers on Oahu, up to 2 DC Fast Chargers on Maui, and a DC Fast Charger on Hawai'i Island by 2016. The fast charger deployment pilot will be evaluated at that point and appropriate adjustments to future installation and operation plans will be made.

The Companies also will seek opportunities to be involved in the following strategic areas of EV charging infrastructure development: public charging, workplace charging, EV charging at multifamily dwellings (MFDs), and encouraging daytime charging, as discussed below.

**Public Charging:** With the approval of Schedule EV-F and Schedule EV-U by the Commission in July 2013 in Transmittal No. 13-07, the Companies will continue to focus efforts to expand public charging infrastructure. The Companies see expansion as necessary to build public confidence in EVs and to mitigate driver anxiety about running out of charge before getting to their destination or home. Many residents, especially those living in MFDs, do not have access to an EV charger, or they face high costs for installing a unit in their building. For these customers, determining how they will charge their new EV will be almost as important as determining the type of EV to buy. Expansion of public charging facilities in nearby areas may help persuade new

#### 4. Advanced DER Technology Utilization Plan (ADERTUP)

##### 4.5 Electric Vehicles (EV) and Electric Vehicle Supply Equipment (EVSE)

automobile buyers to consider an EV, because a public charging facility is easily accessible.

**Workplace Charging:** Workplace EV charging is another opportunity that the Companies intend to investigate to support widespread EV adoption. Other than at home, the workplace is the next best location to charge an EV, because it is parked for several hours during the day and remains plugged-in for EV charging. Workplace EV charging can provide daytime charging loads to use excess supply of electricity, if managed. With the EV remaining plugged-in, EV charging may be curtailed temporarily during a system event or charging may be delayed for best use of load to offset RDG. The workplace is an ideal location for EV owners to recharge their EVs and for the utility to control EV charging to support grid operations.

Workplace charging also provides an opportunity to add more load to the grid, and, consequently, enables more renewables to be added to the grid. EV charging in the workplace environment is one area where EV charging aligns well with peak PV production. EVs in large numbers have the potential to provide significant new loads that could consume excess energy generated from PV and other renewable sources. The Companies will explore workplace opportunities through RD&D projects, depending on the availability of RD&D funding.

**EV Charging at MFDs:** In Hawai'i, about 39%<sup>39</sup> of all households reside in MFDs, and the Honolulu area has more than 15 projects in the permitting or construction phase of MFDs, which represent more than 5,400<sup>40</sup> new units. With population growth exceeding the construction of new homes in Honolulu, more developers are building MFDs to address the potential shortage of housing units. On Oahu, it is estimated that 3,525 new homes or housing units must be added for each percentage increase in population.<sup>41</sup> Charging EVs in MFDs is a challenge and access is limited. The increase in the number of EVs is still uncertain, and many developers are interested in providing access to EV charging infrastructure if it can be shown to be cost-effective and provide additional value to the residents of an MFD project. Costs are a major barrier when installing another meter and running additional power in the parking garage to a designated stall. The Companies propose to take a proactive role in helping developers incorporate EV charging into new building designs and investigate alternative metering technologies to reduce the costs of metering and billing each EV customer for energy use for EV charging.

**Encourage Daytime Charging:** In addition to public charging, the Companies also intend to investigate opportunities to increase the daytime minimum loads so that more

<sup>39</sup>Hawaii QuickFacts, U.S. Census Bureau, <http://quickfacts.census.gov/qfd/states/15000.html>.

<sup>40</sup>"More Towers on the Rise," *Honolulu Star Advertiser*, May 29, 2014, pg. A1.

<sup>41</sup>Id at A-6.

renewables can be added to the grid. Separately, PV and EV charging can adversely impact grid reliability and stability. High penetration of PV and low minimum loading can cause reverse power flow conditions, causing voltage rise excursions that affect power quality on distribution circuits. High penetration of EV can introduce new loads that could place additional burdens on the distribution circuit and that can cause overloading on existing distribution system components, predominantly the secondary transformers. If, however, EV loads can be managed to operate at nearly the same time that PV generation is at peak production, it is possible to make EV and PV complementary to each other, where both work coincidentally to offset the effects of the other. With high penetration of EVs, the increased loads from EV chargers can be used to depress voltage rise. With high penetrations of EV, PV can be introduced to reduce loads on secondary transformers and prevent overloading.

### 4.5.3 Technology Interoperability and Integration

Successful and seamless integration of technologies, systems, and applications is imperative to the success of the plug-in EV, EV supply equipment (EVSE), and EV service provider (EVSP) industry. Historically, system integration has been a challenge for utilities and their vendors, due in large part to proprietary systems and technologies. The EV, EVSE, EVSP, and Advance Demand Response (ADR) ecosystem must address this challenge, because the ability to provide EV owners with hassle-free driving and charging is a prerequisite for the ability of the Companies to incorporate them into future load response programs.

The utility and automotive industries have been working to develop interoperability standards for several years; many are still in progress. **Table 4-13** provides examples of standards that could influence the technologies and may impact programs the Companies will be studying.

Document No.	Title
J2847/1	Communication between Plug-in Vehicles and the Utility Grid
J2847/3	Communication between Plug-in Vehicles and the Utility Grid for Reverse Power Flow
J2931/5	Telematics Smart-grid Communications between Customers, Plug-In Electric Vehicles (EV), Energy Service Providers (ESP), and Home Area Networks (HAN)
J2953	Plug-In Electric Vehicle (EV) Interoperability with Electric Vehicle Supply Equipment (EVSE)
J2847/6	Wireless Charging Communication between Plug-in Electric Vehicles and the Utility Grid

Table 4-13. Examples of SAE Standards Supporting EV/EVSE/Utility Activities<sup>42</sup>

<sup>42</sup> Argonne National Laboratory, “Codes and Standards Support for Vehicle Electrification,” 2013 DOE Hydrogen Program and Vehicle Technologies Annual Review, Project ID No. VSS053, pg. 13.



#### 4. Advanced DER Technology Utilization Plan (ADERTUP)

##### 4.5 Electric Vehicles (EV) and Electric Vehicle Supply Equipment (EVSE)

Interoperability and integration activities must focus specifically on what devices, systems, and/or applications must be implemented in Hawai'i. A **device** is defined as a piece of hardware that performs a specific set of functions for the customer or company. EV and EVSE are obvious examples of devices that the Companies would need to communicate with during planned events. However, smart meters and home energy management gateways also are examples of devices.

A **system** is the software foundation for the basic control and operation of a device. Examples include an EV Telematics System, EVSE Management System, or AMI Head-End System. An **application** is software developed to perform specific actions through control of a device or to collect and analyze information from devices, systems, or other applications. ESVE Locator and Usage Monitoring are examples of applications.

The Texas River Cities Plug-In Electric Vehicle Initiative Regional Plan identified over 190 integration points that occurred among devices, systems, and applications. These were documented and estimates were made as to when these issues must be addressed. The plan identified 49 priority integration points – the points that must be completed in the short term (0-2 years) if the TRC wants to manage EVs and EVSE as part of its DR programs.<sup>43</sup>

#### 4.5.4 EV Roadmap

The EV Roadmap shown in **Figure 4-14** provides the Companies' high-level plan to facilitate EV deployment, in the short-, mid-, and long-term horizons. The Companies recognize that currently there are not enough EVs to contribute sufficient loads to balance the high penetration of RDG or to severely impact the grid. It will take time for the number of EVs in Hawai'i to reach the critical mass needed to have an appreciable effect.

---

<sup>43</sup> Texas River Cities Plug-In Electric Vehicle Initiative Regional Plan and Final Report, pg. 6-2; available at [www.texasrivercities.com](http://www.texasrivercities.com).

## 4. Advanced DER Technology Utilization Plan (ADERTUP)

### 4.5 Electric Vehicles (EV) and Electric Vehicle Supply Equipment (EVSE)

Electric Vehicle Roadmap

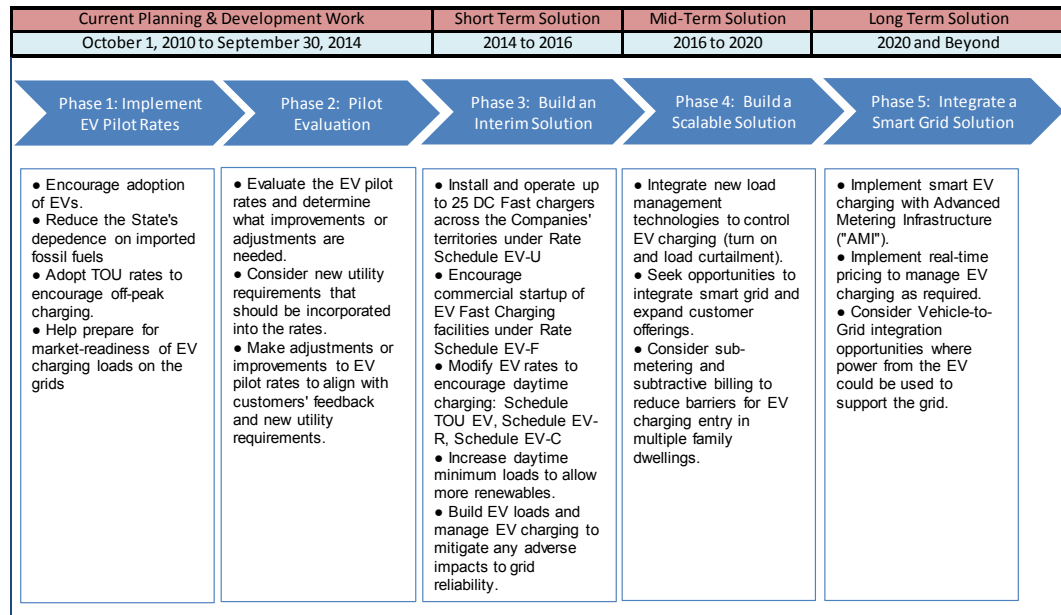

Figure 4-14. EV Roadmap

New ideas and strategies with innovative technology must be developed, standardized, deployed, and tested before it is possible to take advantage of new opportunities. Providing EV charging access at the workplace and in MFDs and enabling vehicle-to-grid (V2G) integration are areas that the Companies will explore in the mid- to long-term to encourage widespread adoption of EVs and subsequent expansion of the EV market share of vehicles purchased in the Hawai'i. V2G integration is an area of much interest among many utilities because EVs potentially can be used to provide grid services by injecting power to support the grid when generation and distribution equipment are near capacity. However, V2G integration will require two-way interaction between the utility and the individual EV to manage and modulate EV charging based on current system needs. Development of industry, safety, and communications standards are essential to achieve V2G integration and may not be available until the long term.

In the short term, a practical interim solution is load management through TOU rates to control when EV charging occurs. As EVs grow in popularity, however, it will be necessary to manage EV charging loads and to expand EV charging facilities into commercial markets to increase access to charging services. Challenges to widespread adoption of EV charging must be solved before the full benefits can be realized. To meet those challenges, new innovative technologies such as smart grid, AMI, load management strategies, and smart charging must be developed and used within an integrated solution to open the market opportunities for EV in Hawai'i.

## 4.6 NON-EXPORT DISTRIBUTED GENERATION

Non-export DG is defined as generation for customer use only, not operated in parallel to the electric utility system. There is no excess capacity transmitted to the distribution grid. This solution has been determined to be significant to the future of deploying DG in Hawai'i. Section 5 of this DGIP provides a detailed solution for non-export DG.

---

## 4.7 ENERGY EXCELERATOR PROGRAM AND OTHER PILOT PROGRAMS

### 4.7.1 Energy Excelsator Overview

In February 2014, Energy Excelsator, a program designed to help energy innovation within the Companies to navigate markets in Hawai'i and the Asia Pacific region, partnered with the Companies in its first private-public partnership. As part of this partnership, HEI contributed \$250,000 to help Energy Excelsator create an innovation space for its start-ups in downtown Honolulu.

Energy Excelsator, a program of the Pacific International Center for High Technology Research (PICHTR), funds seed-stage and growth-stage start-ups that have compelling energy solutions and immediate applications in Hawai'i, helping them succeed by providing funding, strategic relationships, and a vibrant ecosystem. The start-up program has helped 32 energy-related companies generate nearly \$20 million in revenue, supported more than 400 jobs, and raised over \$55 million of follow-on funding.

The Energy Excelsator looks for technologies that can solve real-time problems, such as managing renewables on the grid, integrating smart energy efficiency technologies, and reducing the use of petroleum products for transportation. The start-up teams view the challenges Hawai'i faces in energy as an opportunity to reduce energy costs and become less dependent on fossil fuels.

The Hawaiian Electric Company is collaborating with several Energy Excelsator companies. **Table 4-14** lists the companies and summarizes their engagement, value proposition, and the potential 2020 outcomes.

**4. Advanced DER Technology Utilization Plan (ADERTUP)**  
 4.7 Energy Excelsator Program and Other Pilot Programs

Company	Technology	Technology Readiness Level (TRL)	Priority	Engagement	Value Proposition	Hawaiian Electric 2020 Outcomes*
Stem	Distributed storage technology	7-8	Short-Term	Collaboratively deploy to the filed Stem’s customer-sited battery systems to evaluate customer savings levels through energy management options and dynamic load response capabilities supportive of the grid. Demonstrate mutual benefits, with value to customers and to utility.	Demonstrate distribution-level Volt/VAR-level control and energy storage to manage PV variability. Target opportunities for new utility service programs with larger commercial customers. Provide actual cost data and grid performance for design of future tariffs and cost models.	Meet or exceed RPS of 25% Reduce customer bills by 20%
People Power	Tools and software enabling customers to control and customize their load management needs through mobile phone applications	8-9	Mid-Term	Deploy usage monitoring devices linked with mobile applications and appliance plugs. Improve ability to see customer usage profiles (sub-hourly and hourly) and enable customers to customize their energy use environment. Prototyping capability with 70 utility employee volunteers monitoring data and providing feedback on applications.	Enable customer engagement; add value by providing utility with information and facilitating customer customization and control of customer’s energy use. Target opportunities for new utility offerings for small business and residential customers.	Reduce customer bills by 20% Achieve Customer Satisfaction Ratings
Ibis Networks	Plug-load energy management services	8-9	Mid-Term	Deploy Ibis sensors at utility and DOE sites to characterize energy use and locate energy-“hogging” appliances.	Provide more accurate energy use and management services using secure data analytics. Target commercial organizations.	Reduce customer bills by 20% Achieve Customer Satisfaction Ratings

**4. Advanced DER Technology Utilization Plan (ADERTUP)**

**4.7 Energy Exceleator Program and Other Pilot Programs**

Company	Technology	Technology Readiness Level (TRL)	Priority	Engagement	Value Proposition	Hawaiian Electric 2020 Outcomes*
Amber Kinetics	Flywheel technology	1-3	Mid-Term	Advisory only (industry needs and considerations)	Potential future flywheel technology offering dynamic inertia and voltage support, using non-chemistry-based energy storage.	Meet or exceed RPS of 25%
Ambri	Liquid metal battery	1-3	Mid-Term	Advisory only (industry needs and considerations)	Potential future technology providing system energy storage with non-chemistry-based system. Potential benefits of increased life expectancy and ease of metal salvage at end of life using non-chemistry solution.	Meet or exceed RPS of 25%
Shifted Energy (dba Kanu Hawai'i)	Grid-interactive water heating (GIWH) technology	6	Short-Term	Contract with Hawaiian Electric to explore using GIWH as a demand response tool. Director of Demand Response at Hawaiian Electric presented, with support of Kanu Hawai'i, at an industry webinar on the GIWH project.	Large-capacity electric thermal storage water heater becomes a "thermal battery" for storing electric energy (e.g., renewable, off-peak, low cost) with the ability to closely follow renewable availability.	Reduce customer bills by 20% Meet or exceed RPS of 25%

\* Column indicates that respective technology contributes to achieving Hawaiian Electric targets.

Table 4-14. Energy Exceleator Engagements

As these start-up product and services offerings reach technical maturity and market-readiness levels aligned with the Companies’ distributed resource integration roadmap and timeline, it is envisioned that these products and services could further enable integration. Therefore, the Companies fully support the Energy Excelerator program’s goal of advancing innovation in Hawai’i and strongly encourage further development of this program.

### 4.7.2 Technology Evaluation Processes

The U.S. Department of Energy (DOE) has established a methodology to evaluate technology maturity using the Technology Readiness Level (TRL) scale, pioneered by the National Aeronautics and Space Administration (NASA) in the 1980s. The TRL scale ranges from 1 (basic principles observed) through 9 (total system used successfully in project operations). Essentially, TRLs 1-3 are pure research and development (R&D), TRLs 4-6 are prototype bench-scale tests, and TRLs 7-9 levels are scaled demonstration and ready for scaled commercial testing. To field-deploy new technologies, the Companies look for products with a TRL 7-9.

Technology evaluation is an ongoing process, as new products, applications or systems gradually move up the TRL scale. **Figure 4-15** illustrates a process proposed for use by the Companies. Moreover, this process may be iterated several times as technologies move from prototypes to pilots, and then to commercialized products.

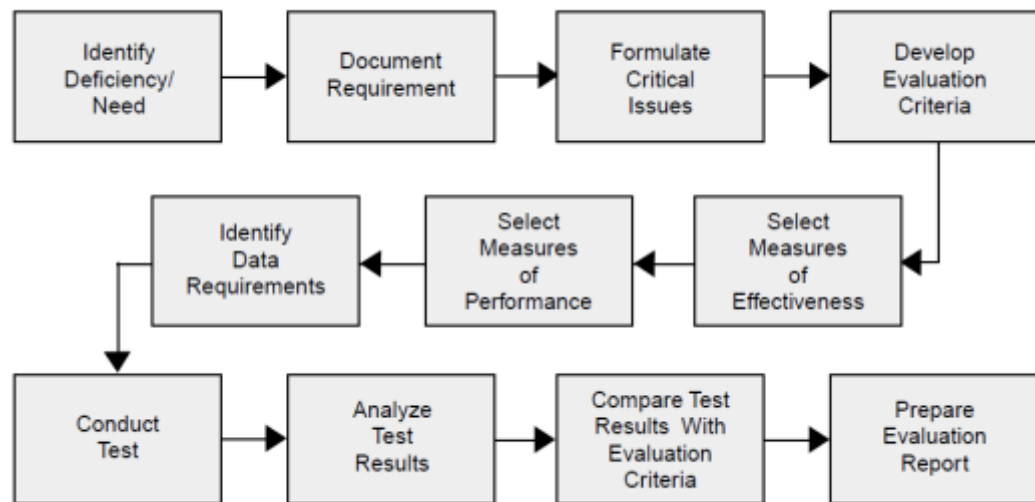

Figure 4-15. Advanced Technology Project Evaluation Process

#### 4. Advanced DER Technology Utilization Plan (ADERTUP)

##### 4.7 Energy Excelsator Program and Other Pilot Programs

### 4.7.3 Technology Piloting Program

The Companies have been very active during the past several years in evaluating technologies and applications that will help manage DG activities. The projects span a range of activities, from energy storage technologies to inverters to circuit-monitoring applications. **Table 4-15** is a summary of the projects that are ongoing and/or planned as part of the Companies' ADERTUP efforts.

Project	Description	Project Time Frame
<i>ENERGY STORAGE</i>		
Hawai'i Electric Light Hawi BESS	Power Smoothing and frequency support for the Hawi Wind Farm	2012-2017
CIP BESS Demo	Frequency and voltage support, power smoothing	2014-2017
Maui Electric Smart Grid BESS at Wailea Substation	Research, test, and evaluation of energy storage as part of the smart grid implementation project for voltage regulation, peak load shifting, and reserve support	2010-2013 and continuing data collection and analysis to the present
Hawai'i Electric Light Power Conditioner	Containerized storage for mobility and testing at different sites. Intended to stabilize voltage and frequency fluctuations and to help evaluate the system's ability to help the grid increase DG capacity on the circuit	2010-2012 and still continuing data collection and analysis to the present
Molokai BESS	It will be a Secure Microgrid BESS as part of the smart grid implementation project. Research, test, and evaluation of PV integration, voltage regulation, and reserve support	2015-2020
EPRI Project—Greensmith BESS and Ancillary Services Test	Test and evaluate the performance, efficiency, durability, reliability, and grid compatibility of a Photovoltaic (PV)-charged Lithium Ion (Li-Ion) battery system with an EV charge station as a load. BESS functions evaluated are PV smoothing, demand peak shaving, ramp rate control, voltage regulation, and frequency response capabilities.	2010-2015

**4. Advanced DER Technology Utilization Plan (ADERTUP)**  
 4.7 Energy Excelerator Program and Other Pilot Programs

Project	Description	Project Time Frame
Hawaiian Electric PV and BESS EV Carport	Flexible Hawaiian Electric Test Bed with existing EV and PV systems. Facility can integrate system specimen/s for testing like BESS, advanced inverters, Microgrid, ATS, load banks, and other system combinations for simulating grid responses and unit functionalities	2015 and beyond— Can be converted to a company asset upon completion of EPRI/Greensmith Project
E-Gear	Demonstrating the potential to use grid-tied storage to limit variability of PV/customer loads, provide grid-interactive ancillary services, and enable monitoring of customer generation.	2014-2016
<i>DER, PV/INVERTER ASSESSMENT</i>		
TrOV-compliant equipment list	Technical review, evaluation, and validation of TrOV-compliant inverters and establishment of database and references	Ongoing
Hawai'i Electric Light Baseyard PV/Inverter	PV/inverter testing and evaluation project	
Smart Inverters for Hi-Pen PV Applications—Maui	Developing and demonstrating utility-controlled, smart-enabled PV inverters to reduce the system- and distribution-level impacts of distributed PV systems and facilitate their broader adoption at lower cost	2010-2013 and still continuing data collection and analysis to the present
Maui Electric Baseyard PV/Inverter	PV/inverter testing and evaluation project	2012—no end date; company asset
Kahe Advanced Inverter	Princeton DRI-100 PV/inverter performance and functionality testing	2014-2015
UH COE Advanced Inverter test platform	Inverter Test Facility in UH Manoa to leverage on the Academic Assets of the College of Engineering (COE). Test Bed has existing Solar PV and can be used to test and verify functionalities of advanced inverters from different manufacturers	2014-2016



#### 4. Advanced DER Technology Utilization Plan (ADERTUP)

##### 4.7 Energy Exceelerator Program and Other Pilot Programs

Project	Description	Project Time Frame
Hawai'i Electric Light NELHA Gateway PV/Inverter	As part of the Hawai'i Electric Light BESS Project to test and evaluate functionalities of inverter/s to regulate voltage and frequency	2010-2012 and still continuing data collection and analysis to the present
Enphase utility portal development and advanced inverter capabilities and data sharing	Develop a proof-of-concept utility portal to explore the potential to use the Enphase micro-inverter network in support of aggregated monitoring and control of exported PV.	2014-2016
Maui Electric—Heart Transverter advanced inverter capabilities and energy storage	EPRI-sponsored advanced inverter testing in laboratory and in field installation to test and validate functionalities of the Heart Transverter, such as Ramp Rate, Frequency Regulation, Load Shifting, Volt/Watt, LROV, VF Ride Through, Load Isolation, and PV System monitoring and control	Started 2014 at EPRI w plans to continue in community setting at Maui Electric
Sunverge advanced inverter capabilities and energy storage	PV/inverter testing	2013-2014
EPRI/HNEI smart inverter testing—Fronius and Hitachi	As continuation of the RDSI-JUMPSmart interoperability project, existing inverters will be replaced with Advanced Inverters to test and evaluate functionalities, such as voltage and frequency regulation, ride-through, V/VAR, V/Watt, energy management, enable residential PV, other inverter controls, and grid support services	2008-2014 and to be extended for new Advanced Inverters
SolarCity—NREL Advanced Inverter Testing	This project will use NREL's Energy Systems Integration Facility and its power hardware-in-the-loop capability to test advanced inverter functionality and analyze DG and distribution equipment as it being used. Tasks that will be completed include 1) testing of PV inverter transient over voltages, 2) anti-islanding of multiple inverters, 3) advanced inverter volt/VAR support, and 4) bi-directional power flow.	2014-2015
<i>SMART GRID AND MICROGRID</i>		
Oahu Smart Grid Initial Phase	The Initial Phase demonstration will implement a suite of smart-grid applications, including AMI, Customer Energy Portal, Prepay, VVO, Distribution Automation (DA) with FCIs, Outage Management, and DLC, for about 5,200 customers across six circuits.	2014-2015

**4. Advanced DER Technology Utilization Plan (ADERTUP)**  
 4.7 Energy Excelsator Program and Other Pilot Programs

Project	Description	Project Time Frame
DOE RDSI Maui Smart Grid	Demonstration of Smart Meter and access to a personalized secure website that provides data on energy usage. Additional technologies included an in-home energy use display; a smart thermostat, accessible remotely; a smart water heater control system; and a solar PV monitoring system	2008–2014 and to continue data collection and analysis
JUMPSmart Maui Demonstration Project—Phase 1	Demonstration of batteries as part of the Smart Grid implementation: 1) substation level bulk storage and 2) community-level storage systems	2013–2015 and time extension requested to 2016
Great Maui Project—Phase 2	Escalation and enhancement of Phase 1 to demonstrate Advanced DER, aggregated and integrated systems using Virtual Power Plant Architecture, Integrated SmartPCS, DMS and ·DMS, Clustered control using Grid Control Systems, System Interoperability, Grid support services, etc.	2014–2017 proposed
Smart Campus Energy Laboratory (with UH COE, Ron Ho & Assoc.)	Campus-focused approach to deploy new distribution equipment, modeling capability, and monitoring devices to enable an operational microgrid at the UH Manoa campus. Facilities and laboratories would be available to provide an active nexus for smart grid research.	Proposal in discussion
<i>ENERGY EXCELERATOR INITIATIVES</i>		
GridCo active Volt/VAR compensation	Advance power regulation project, aimed at providing volt/VAR management on high penetration PV circuits	2014–2017
STEM distributed storage	Distributed storage targeting commercial and industrial load management to be coordinated with utility to help manage high penetration PV conditions	2014–2017
People Power End-user Engagement using the Presense Application via web-based applications	Effort to enable better end-user engagement and options, using load data to customize, access utility information, and gain visibility and control to manage in-home devices using web-based applications.	2014–2017
IBIS Networks Device Use and Controls Monitoring	Effort to offer and enable customer customization, visibility, and controls to better manage device health and usage and support data-driven analysis for load management.	2014–2017
<i>DR/GRID INTERACTIVE WATER HEATING</i>		

#### 4. Advanced DER Technology Utilization Plan (ADERTUP)

##### 4.7 Energy Excelerator Program and Other Pilot Programs

Project	Description	Project Time Frame
EPRI-Hawaiian Electric-Maui Electric-Kanu HI Water Heater Smart Control Demo	Grid interactive water heater is a pilot to test the water heater as a thermal storage unit, with the ability to charge and discharge to integrate more renewable energy.	2013-2015
Hawaiian Electric-Maui Electric C&I Fast DR Pilot	FastDR is a pilot program to operate a DR program faster with commercial customers using the OpenADR standard. Currently there are roughly 6 MW of participants for this pilot.	2012-2014, will be requesting for transition of the program for 2015
Existing DR programs (RDLC, CIDLC)	Current DR program available to participants is a 1-way paging peak load shedding program. Between the residential and commercial, there are roughly 28 MW of program load that can be dispatched.	2005-2014, will be requesting for transition of the program for 2015
<i>RENEWABLES INTEGRATION AND PLANNING</i>		
Solar and Wind Integrated Forecasting Technology (SWIFT) and Monitoring Network	This is a system-focused capability. The Companies are operationalizing one of the first integrated wind and solar real-time forecasting capability with AWS Truepower. Short-term forecasts are improved using a fleet of remote sensing devices (radiometer, pyranometer, SODAR and LIDAR).	2009-2015 with ongoing operational usage
SMUD/SMUD High Penetration PV Initiative (HiP-PV) Assessment	Funded by the California PUC, Hawaiian Electric Companies partnered with SMUD to address critical gaps in managing high penetration PV issues on the grid. Three focus areas developed include: <ul style="list-style-type: none"> <li>■ Enhanced models using the Proactive Approach Methodology to assess the impact of distributed PV on the T&amp;D system</li> <li>■ Deploying solar irradiance network (SolarNET) to gather long-term solar resource data for modeling and real-time forecasts</li> <li>■ Developing visualization capability with the energy management system (EMS) to integrate probabilistic renewable energy forecasting and distributed generation data for real-time operations.</li> </ul>	2012-2014

**4. Advanced DER Technology Utilization Plan (ADERTUP)**  
 4.7 Energy Excelerator Program and Other Pilot Programs

Project	Description	Project Time Frame
Distributed Resource Energy Analysis and Management System (DREAMS) for System Operations	USDOE Sunshot Initiative is designed to develop a “next-generation” energy management system (EMS) and to help utility system operators manage increasing amounts of variable renewables on electric grids. Efforts focus on to integrating real-time renewable forecasts into EMS and accounting for residential distributed solar in state-estimation calculations, load forecasts, and unit commitment functions.	2014-2016
EPRI-Hawaiian Electric Forecasting and Solar Nodal Modeling	Partnership with EPRI and industry to improve utility modeling tools and streamline studies that need to account for distributed PV. Efforts focused on a methodology to aggregate and equivalence the distributed PV into system models. Approach enables consistency of data and more accurate assessment of the impact of distributed PV on the system.	2012-2014
Hawaiian Electric-Utility Advisory Team (UAT) on Visualization, Modeling Tools, and EMS Integration	Collaboration between Hawai’i and western utilities to develop visualization and modeling tools to track and assess increasing impacts on renewable generation on their systems. Efforts have expanded to include monitoring, data analytics, and EMS integration of real-time renewable energy forecasting data. UAT is a Hawaiian Electric-led advisory group of utilities that are partnering to share lessons based on common T&D models, EMS systems, and field equipment	2013-ongoing
Hawaiian Electric Synchrophasor Visualization effort	Funding provided by US DOE to better use synchrophasor data for grid management and real-time controls considering impact of high penetration PV. Visualization, model validation, and predictive analysis are the focus.	2014-2016
Hawaiian Electric-DBEDT Wind and Solar Resource Maps Development	Funding provided by US DOE. Efforts focus on developing revised wind resource potential and new, high resolution solar resource maps for the State of Hawai’i. 1 km by 1 km GIS-based maps of solar and wind resource information helps standardize portfolio analysis studies using a common baseline; periodic refinements are anticipated as new field data and improved satellite imagery are gathered	2014-ongoing

## 4. Advanced DER Technology Utilization Plan (ADERTUP)

### 4.8 Advanced Technology Costs

Project	Description	Project Time Frame
REDatabase	Funded under HREDV, collaborative effort with Referentia Systems to implement its rapid time-series data management and data analysis capability (TRES) as a consolidated platform to centralize utility data from multiple database platforms, conduct analysis, and track change on the systems. Platform and architecture leverage secure Interface Protocol and are being deployed to Companies to support data-driven analytics for decision-making.	2012-ongoing
Hawaiian Electric-LBNL-UC Micro-PMU Technology Research and Evaluation	Funded by US DOE, efforts leverage collaborations with LBNL and University of California to evaluate use of micro-PMU (Phasor Measurement Unit) technology to improve model performance and inform use of high resolution power quality and phase data collected at the distribution level	2014-2016

Table 4-15. Advanced Technology Project Summary

## 4.8 ADVANCED TECHNOLOGY COSTS

The costs to implement the advanced technology roadmap are accounted for differently in different programs. In some cases, the costs will be borne by the customers themselves. In other cases, the technology is not mature enough for deployment and needs development (demonstration projects). **Table 4-16** provides a summary of where the costs for the different categories reside:

4. Advanced DER Technology Utilization Plan (ADERTUP)  
4.8 Advanced Technology Costs

Technologies	Grid Modernization	Integrated Demand Response Portfolio Plan	Demonstration Program	Costs Borne by Customer
Modern Grid	✓			
Two-Way Communications	✓			
Advanced Inverters			✓	✓
Distributed Energy Storage			✓	✓
Demand Response		✓		
Electric Vehicles			✓	✓
Non-Export Systems			✓	✓
Energy Exceleator and Other Pilots			✓	

Table 4-16. Advanced Technology Programs and Costs

The Companies will oversee ADERTUP-related development and the maturation of the associated technologies. A central organization will be the primary point of contact among the Companies, the industry, and interested parties. The Companies will develop laboratories for testing inverters, non-export systems, and EV technologies.

Demonstration programs for distributed energy storage and future EV efforts will be conducted. It also will coordinate interactions with the Distributed Energy Resources (DER)-Technology Working Group (DER-TWG), as directed in the Order.

To fund the purchasing of infrastructure and test equipment associated with this function, the Companies propose the funding profile in **Table 4-17** for first 3 years of funding. As the projects proceed, the Companies will review the project costs and make subsequent requests in future years if needed.

Project	Annual Costs (\$000)				Cost Breakdown (\$000)			
	2015	2016	2017	Total	Capital	O/S	Labor	Total
Inverter Testing Program	90	290	290	870	0	750	120	870
Substation Storage Demo Project (2016)	60	2,120	20	2,200	1,900	150	150	2,200
Outside Services—DER Assessment, RD&D, Controls	140	165	202	507	0	507	0	507
<b>Totals</b>	<b>490</b>	<b>2,575</b>	<b>512</b>	<b>3,577</b>	<b>1,900</b>	<b>1,407</b>	<b>270</b>	<b>3,577</b>

## 4. Advanced DER Technology Utilization Plan (ADERTUP)

### 4.9 Technology Assessment Roadmap

*\*calculations in current year dollars*

Table 4-17. Advanced Technology Project Cost Breakdown

Many of the industry technology development activities with smart inverters, energy storage, and even modern grid technologies will directly influence DG management activities with the Hawaiian utilities. As mentioned, many of the operating characteristics of utilities on islands are unique, and differ from mainland utilities' activities. Therefore, the Companies will continue to be involved in the standards and technology development activities in different industry committees, such as the IEEE 1547 Working Group and the Smart Inverter Working Group (SIWG).

---

## 4.9 TECHNOLOGY ASSESSMENT ROADMAP

**Figure 4-16** provides a summary of roadmap activities for each technology section in the Advanced Distributed Energy Resource Technology Utilization Plan. These activities are broken down into three time frames: short-term, medium-term, and long-term.

4. Advanced DER Technology Utilization Plan (ADERTUP)  
4.9 Technology Assessment Roadmap

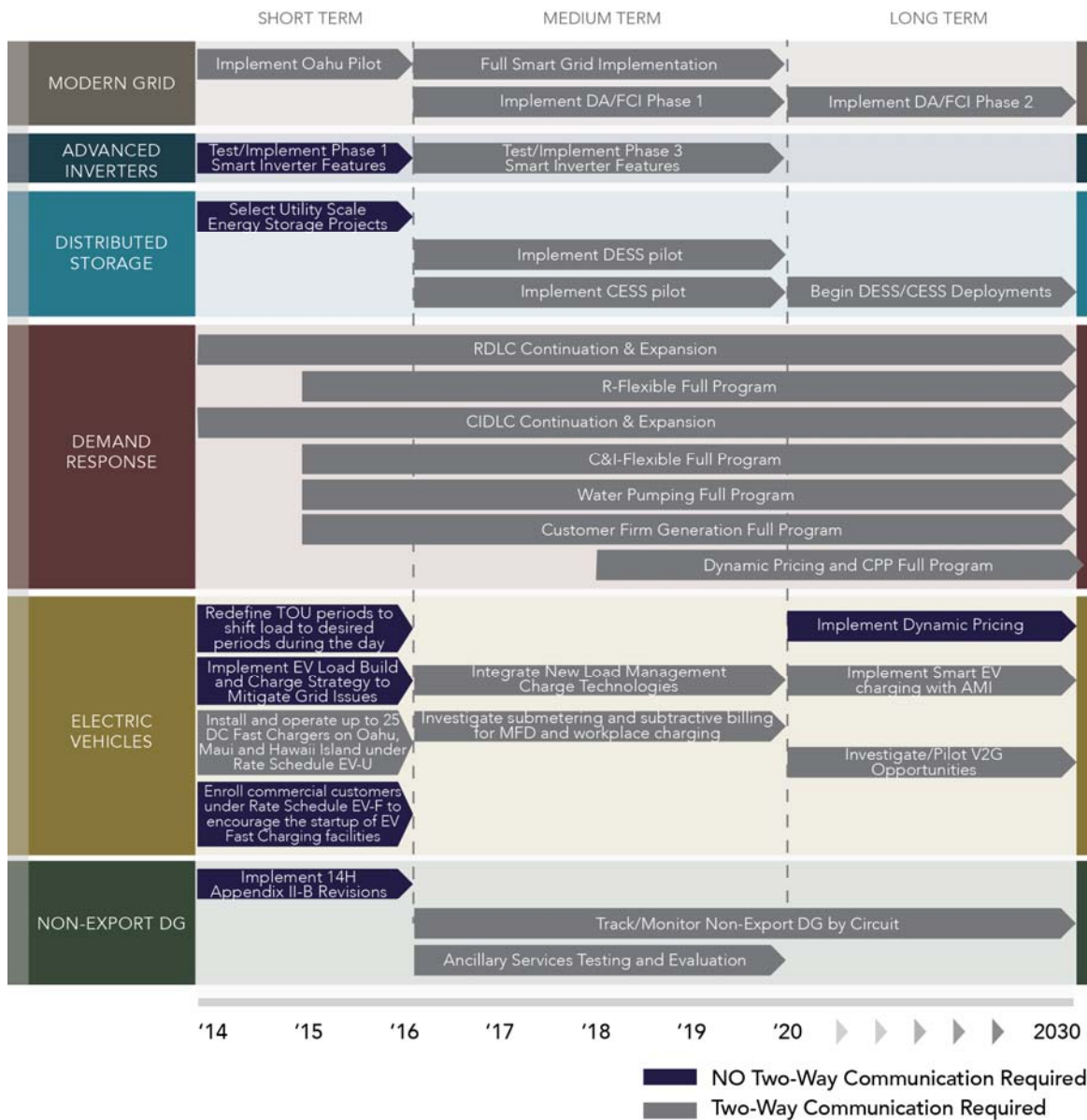

Figure 4-16. Advanced DER Technology Roadmap



**4. Advanced DER Technology Utilization Plan (ADERTUP)**  
4.9 Technology Assessment Roadmap

This page intentionally left blank.

# 5. Non-Export Distributed Generation System

## 5.1 NON-EXPORT OVERVIEW

Non-export DG is generation for customer use only; that is, there is no excess capacity transmitted to the distribution grid. There are a number of ways to configure a DG system to prevent power export and such systems may or may not incorporate energy storage. These may include small PV systems without storage and with the appropriate inverter controls that have been designed and optimized to address backfeeding and ride-through events while serving customer loads. The Companies have proposed a process for evaluating non-export DG systems in Docket No. 2014-0130.<sup>44</sup> Based on the criteria for interconnection approval set forth in this docket, non-export DG is defined as a DG system that is: (1) interconnected to the distribution system; (2) does not operate in parallel with the distribution system; (3) does not export power to the distribution system; (4) and incorporates energy storage (“Non-Export DG”). Parallel operation has been defined in Docket 2014-0130 as:

*“Parallel Operation: The operation of a DG facility, while interconnected, such that customer load can be fed by the DG facility and the distribution system simultaneously.”<sup>45</sup>*

Docket 2014-0130 proposes an expedited interconnection approval process for Non-Export DG systems as discussed in detail in Section 5.3.

Typical exporting PV systems are intermittent generators and must operate in parallel with the grid and remain continuously connected to the grid in order to provide reliable

<sup>44</sup> Docket 2014-0130, Hawaiian Electric Company, Inc., Hawai'i Electric Light Company, Inc., Maui Electric Company, LTD., For Approval to modify Rule 14H-Interconnection of Distributed Generating Facilities Operating in Parallel with the Companies' Electric System, File June 2, 2014.

<sup>45</sup> Attachment1, 82

## 5. Non-Export Distributed Generation System

### 5.1 Non-Export Overview

power to the customer loads. Intermittent DG systems that do not operate in parallel with the grid must incorporate some form of energy storage to continuously serve load.

A DG system can be configured to be non-exporting and operate in parallel with the distribution system (“Parallel Non-Export DG”). Parallel Non-Export DG may or may not incorporate energy storage depending on the system design and customer load profiles and offers more customer flexibility, while preventing power from being exported. Parallel Non-Export DG systems (with or without energy storage) are not eligible for expedited interconnection approval in Docket 2014-0130. DG systems over installed under the standard interconnection agreement are effectively Parallel Non-Export DG systems, as discussed below.

Non-Export DG systems have advantages when compared with exporting DG systems for the utility and the customer as the major issues are driven by the export of energy onto the circuit. Higher volumes of Non-Export DG systems can interconnect onto circuits that have not reached limitations. Non-Export DG can reduce the need for distribution circuit upgrades that would be caused by exporting DG of similar capacity. System-level operational constraints also can be alleviated when compared to exporting DG; however, Non-Export DG is not without impact. Non-Export DG does not solve issues caused by existing exporting DG. Reduction in load from Non-Export DG will have system-level operational impacts at high levels of adoption due to increased net excess generation from existing exporting DG. On the circuit level, transient effects and excess generation from existing exporting DG are exacerbated by the reduction in load from Non-Export DG. From a technical perspective, Parallel Non-Export DG (with energy storage) will have similar benefits and impacts as Non-Export DG to the utility and the customer, depending on the system design, sizing, and customer loads.

Currently, DG systems installed under the Companies’ standard interconnection agreement (“SIA”) are not compensated for energy that is exported to the grid. Customers interconnecting under the SIA are economically incentivized to install a DG system that does not exceed their load. The SIA typically is for customers who install systems larger than 100 kW that are not eligible for NEM. While not a technical requirement, SIA systems may be considered as a form of Parallel Non-Export DG without energy storage. NEM customers, on the other hand, are incentivized to maximize their annual energy production to potentially reduce their annual net energy usage to zero. The Companies are obligated under NEM to purchase excess energy generated during the day at retail rates and to credit customer usage during hours when the DG is not generating. There currently is no limit imposed by tariff on how much energy a NEM customer can export to the grid relative to their electricity usage as excess energy credits are trued-up on an annual basis (i.e., no continuous credit rollover).

In Hawai'i, the majority of the DG capacity interconnected to the Companies' electric systems is from PV systems for residential NEM customers, with the average system size ranging from 6 kW to 7 kW. **Table 5-1** shows the distribution of installed distributed PV capacity across NEM residential and NEM and SIA commercial customers as of June 30, 2014. No SIA installations have been documented for residential customers.

Installed DG Capacity (MW)	Total DG	Total NEM	NEM Residential	NEM Commercial	SIA Commercial	Other DG
Hawaiian Electric	254	196	165	31	31	27
Hawai'i Electric Light	44	38	27	11	5	1
Maui Electric	47	41	29	12	3	3

Table 5-1. Cumulative NEM and SIA Installed Capacity

The NEM program allows customers to achieve maximum utilization of the energy generated from a PV system; however, this program has become unsustainable in its current form, as discussed in Section 6. Non-Export DG is effectively a load offset, similar to exporting DG, but without the excess generation (i.e., reverse power flow).

Typical residential electricity usage is lower than PV generation during daytime hours, resulting in significant quantities of excess power being exported to the grid under the NEM program. High levels of excess PV generation during the day have circuit and system-level impacts. The impacts of exporting DG increase as DG growth increases. While there are other applications, Non-Export DG is specifically considered here as to offset excess generation from residential customers that typically would install an exporting DG system under the NEM program. In the Non-Export DG model, energy storage allows the customer to use the excess energy generated during the periods when DG output exceeds load. When the DG has stopped generating, all or a portion of the customer's load can be supplied from the energy storage system, depending on the size and design of the system.

For commercial customers, Non-Export DG may not be a cost-effective option for reducing electricity use, depending on usage and customer load profile. Many commercial customers have higher daytime loads when the PV system is generating and may already be non-exporting. The configuration of a commercial Non-Export DG system introduces system design challenges and increased costs when attempting to offset high power commercial loads and maintain non-parallel operation. Parallel Non-Export DG with energy storage is a viable option for commercial customers; however, such systems are not eligible for expedited interconnection approval in Docket 2014-0130 as currently filed. Such an installation is effectively no different than an SIA, which is subject to the full interconnection review and circuit penetration criteria under Rule 14H.

## 5. Non-Export Distributed Generation System

### 5.1 Non-Export Overview

**Table 5-2** comparatively illustrates, from a qualitative perspective, the relative positive (green) and negative (red) technical and economic characteristics, to the customer and the utility, of Non-Export DG, compared with NEM exporting DG or no DG. **Table 5-2** is specifically relevant to the current state of the industry, the Companies' electric systems, and existing tariffs because: (1) the capability to control exporting DG is not currently available; (2) the majority of existing DG does not have fast-trip capability to mitigate transient over-voltage; and (3) expanded frequency ride-through settings for exporting DG have not been widely implemented. As inverter technology advances, the grid is modernized, and tariffs are developed and revised, these metrics are subject to change. The issues in **Table 5-2** are discussed in this Section 5.

Issue	No DG	NEM Export DG	Non-Export DG
<b>Technical-Utility</b>			
PV Generation Variability Management	N/A	●●	●●
<b><i>Excess Generation Management</i></b>	●●●	●●●	●●
Transient Over-Voltage Impact	●●●	●●	●
System Operations and Dispatch Impact	N/A	●●●	●
Under-Frequency Collapse	N/A	●●●	●
Load Reduction and System Operational Issues	●	●●	●●
Capability to Meet RPS Under System Constraints	●●●	●●	●●●
<b>Technical-Customer</b>			
<b><i>Resiliency to Utility Outages</i></b>	●●●	●●●	●●●
<b>Economic-Utility</b>			
<b><i>Avoided Distribution System Upgrades</i></b>	●●●	●●●	●●
Higher Levels of Distributed Penetration Under Circuit Constraints	N/A	●	●●
Reduces Utility Scale Renewable Curtailment	N/A	●●	●●
Fixed Cost Recovery	●●●	●●●	
Reduce Non-Compliant Interconnections	N/A	●●	●●
<b>Economic-Customer</b>			
Reduced Electricity Costs	●●●	●●●	●●
Customer Cost Recovery	N/A	●●●	●
Customer Capital Expenditure	●●●	●	●●
<b><i>Interconnection Approval</i></b>	N/A	●●	●●●
Maximize PV Generation	N/A	●●●	●●
Customer Flexibility and Choice	●●	●●●	●
<b><i>Volume of Customers that could install DG under Circuit Constraints</i></b>	N/A	●●●	●●●

Bold Italics denotes most significant features ● = Positive effect ● = Negative effect

Table 5-2. Technical and Economic Characteristics of a Non-Export DG System

Most of the negative impacts from Non-Export DG can be mitigated through careful planning and alignment with standards and technology development of smart inverters. **Table 5-3** identifies these specific concerns and provides responses to them.

**5. Non-Export Distributed Generation System**  
**5.2 Technical Aspects of Non-Export DG**

Concern	Response
Demand reduction from Non-Export DG systems increases excess net generation from existing exporting DG and exacerbates circuit issues (TrOV and circuit upgrades) as well as causing system level operational problems.	This is the case with any demand reduction measure, and therefore, the Companies will be diligent in truing up circuit penetration calculations with the registration of Non-Export DG systems undergoing Rule 14H review. Non-Export DG does not solve all issues with DG integration, but will help to buffer the impact on circuits that are quickly filling up with export DG
During a contingency loss of firm generation, as system frequency drifts downwards, Non-Export DG systems will cause their loads to appear on the grid before substation load shedding blocks are triggered, thereby exacerbating the situation towards possible system collapse. Disturbance ride-through settings should be consistent with the Companies' requirements for exporting DG.	The UL 1741 islanding feature inherent to Non-Export inverters can be set to respond to under-frequency events in such a way as to isolate loads from the grid above the frequency setpoint of substation load shedding blocks thereby creating customer based load shedding. However, if consistency with other DG inverter settings is the goal, they can be set to these settings as well.
These Non-Export inverters will not have the built-in smart inverter features the Companies desire to support the grid. Furthermore, circuit-level issues, such as load rejection TrOV, will not be addressed by manufacturers of Non-Export inverters.	The Companies will leverage the entire body of smart inverter work that has been done and is ongoing in the industry, certification requirements, and standards development addressed by other utilities and commissions (CAC Rule 21 as implemented by SDG&E and others, as well as Germany), and apply this development to the certification of Non-Export inverters.
Non-Export DG systems will have a black start impact: they will exacerbate the "cold DG pickup" issue and additional load from battery charging could cause issues during recovery from system wide outages.	Non-Export DG systems will have the same impact as export systems. Appropriate staggered and delayed restart settings, identified and defined under ongoing standards development, and relay coordination analysis will mitigate this impact. Battery charging load is in parallel with loads served by the non-export inverter systems will not exceed nameplate ratings.

Table 5-3. Non-Export Operational Concerns and Responses

**5.2 TECHNICAL ASPECTS OF NON-EXPORT DG**

In Docket 2014-0130, the Companies filed with the Commission an application to modify Rule 14H to incorporate language to address, among other things, the interconnection of Non-Export DG systems.<sup>46</sup> The fundamental technical requirements of a Non-Export DG

<sup>46</sup> Docket 2014-0130

system are non-parallel operation and that the delivery of electricity into the distribution grid is not permitted. Protections must be incorporated into the Non-Export DG system design to prevent reverse power flow onto the distribution grid if there is a potential for the Non-Export DG system to operate in parallel as stipulated in Screen 4 of the Initial Technical Review Process.<sup>47</sup>The Companies proposed the following two qualifications (among others) for the expedited interconnection approval of such systems that have the potential to operate in parallel with the distribution system:

1. To ensure power is never exported to the Distribution System, the Owner shall install and maintain, at Owner's expense, reverse power protection in the form of either a) Internal Transfer Relay included within an inverter device that is UL-certified to prevent reverse power flow or b) an external reverse power relay.
2. The Company shall install, at Company's expense, a bidirectional advanced meter.

The reverse power protection is required for safety and it is critical, because distribution planning and circuit upgrade decisions will be made based on no power being exported from these DG systems. Installation of electric meters that record exported energy provide for enforcement of non-export requirements. Advanced meters allow data collection to facilitate system operations and planning when this infrastructure has been implemented. Docket 2012-0130 uses parallel operation as the primary criterion for expedited interconnection approval, which is discussed in detail in Section 5.3.<sup>48</sup>

Many options are available from the industry for Non-Export DG. The Companies have engaged with industry in understanding the technical capabilities and integration options of grid-interactive battery-based inverters ("Multimode Inverters") for Non-Export DG applications. Multimode Inverters can interact with the grid (i.e., operate in parallel) and sustain power to isolated loads when the grid fails. Battery-based inverters that are not grid-interactive ("Stand-Alone Inverter") also can be used in a Non-Export DG system. Multimode and Stand-Alone Inverters typically require that a subset of the customer loads (critical loads) be isolated from the main utility-powered customer distribution panel. Any inverter that is interconnected with the grid must conform to the Companies' requirements, including having UL and IEEE certifications. Multimode or Stand-Alone Inverters can also be integrated with a closed transition transfer switch, in which case isolating a subset of customer loads is not necessary. An example of a Non-Export DG system with PV generation that has potential to operate in parallel is shown in **Figure 5-1**, where multiprocessor-based reverse power protection is integrated into a Multimode Inverter.

---

<sup>47</sup> Attachment 1, 112-115

<sup>48</sup> Id Attachment 1, 82, 112-115



## 5. Non-Export Distributed Generation System

### 5.2 Technical Aspects of Non-Export DG

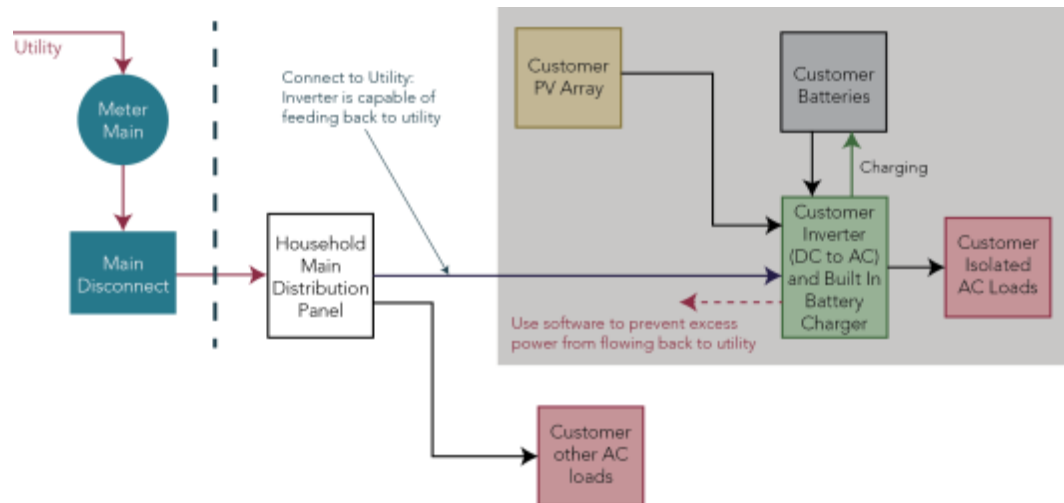

Figure 5-1. Non-Export DG (PV) System

The customer-isolated AC loads can be powered by the DG, energy storage (i.e., batteries), or the utility. These loads are isolated from the household main distribution panel to be able to provide backup power during a utility outage while maintaining compliance with UL anti-islanding standards. This also allows the Non-Export DG system to power the customer-isolated loads without operating in parallel with the distribution system, depending on the inverter technology selected. In the Non-Export DG model shown in **Figure 5-1**, any loads that are not separated into the customer-isolated load panel cannot be powered by the Non-Export DG, because this could cause reverse power flow into the distribution system. For Multimode Inverters, the non-export functionality is must be enabled by the integrator. With Stand-Alone Inverters, the utility is used in a manner similar to how a backup generator supplements an off-grid power system (i.e., battery charging and powering customer loads). Stand-Alone Inverters do not have the capability to export power and are not UL certified as grid interactive.

The energy storage systems associated with Non-Export DG could be used to provide grid support services (e.g., frequency regulation and voltage support) to support system operations and grid stability, provided such systems were permitted to operate in parallel. This is possible only with a Multimode Inverter, because Stand-Alone Inverters are not grid-interactive. This capability also requires that the DG system export power, which disqualifies such a system from the Non-Export DG definition and the requirements detailed in Docket 2014-0130. The Companies will not require utility control of Non-Export DG systems. This reduces the cost to the Companies to implement Non-Export DG and provides a solution that is available today. Future potential for provision of grid support services from customer-sited storage is discussed in more detail in Section 5.7.

## 5.2.1 Non-Export Inverters

Multimode and Stand-Alone inverters are commercially available from several suppliers and offer various operational modes for application flexibility. They serve as an interface between the grid, energy storage, DG, and the customer loads. These inverters can create a power island on the customer side of the interconnection point when the DG and energy storage are supporting the customer isolated loads. For Multimode Inverters, internal reverse power protection is software controlled and typically is provided by a relay and a mechanical switch. Stand-Alone inverters do not have the capability to export power to the grid.

Multimode Inverters will connect to the grid to charge batteries and power loads (if there is insufficient DG) while maintaining reverse power flow protection. This functionality ensures that customers maintain reliable electric service and the health of the energy storage system and represents an additional load that the utility will have to serve. Multimode Inverters have the potential to operate in parallel and may be designed to operate in parallel depending on the programmed operational mode. Multimode Inverters are capable of exporting power and may require external reverse power protection if the internal reverse power transfer relay protection is not UL certified.<sup>49</sup> Multimode Inverters have surge capability, but typically cannot continuously provide more power to the isolated loads than the nameplate rating. If there is insufficient DG output to power the loads and the batteries are drained, the Multimode Inverter would supplement the DG from the distribution system to power the isolated customer loads. Any excess power would charge the battery up to the nameplate rating of the Multimode Inverter or a user-defined charging limit. While this scenario may not occur frequently, it is consistent with the definition of parallel operation. Similarly, a Multimode Inverter could power customer isolated loads in parallel with the distribution system in the absence of DG. It is noted that parallel operation can occur while the non-export functionality is enabled.

Stand-Alone Inverters are similar to Multimode Inverters because they can manage the battery health, DG, customer loads, and can provide limited surge capability. The key difference is that these inverters are not capable of exporting power to the grid and are not UL certified as grid-interactive. Depending on the design and equipment selected, these inverters are significantly less likely to operate in parallel with the distribution system and the customer loads.

UL 1741 certification is available for Multimode and Stand-Alone Inverters. The Companies will investigate the specific details of UL testing and certification of reverse power functionality and protection before implementation of the proposed modifications to Rule 14H in Docket 2014-130. This will streamline the interconnection review process

---

<sup>49</sup> Id Attachment 1, 114

## 5. Non-Export Distributed Generation System

### 5.3 Rule 14H and Non-Export Implementation

and enable the Companies to specify the required documentation for non-export DG applications. Some utilities in California specify type testing protocols for reverse power protection as part of the Rule 21 interconnection review process for non-exporting systems.

#### 5.2.2 Transient Behavior

Transient over-voltage (TrOV) (load rejection) and protection issues are discussed in Section 1.6. TrOV may be increased by excess generation when a circuit breaker opens or when the utility protection systems isolate a circuit. Non-Export DG does not contribute to excess generation and is not likely to cause TrOV in the same manner as exporting DG inverters or to cause protection issues, as discussed in Section 1.6.3. However, reductions in load from Non-Export DG will increase the potential for TrOV impact from existing exporting DG. The Companies are concerned about the potential for transient behavior and the potential impact on the electric system from Non-Export DG installations. The Companies have engaged industry to begin investigating the transient characteristics with respect to exporting and non-exporting inverters. It is possible that non-exporting inverters can be programmed to comply with the fast-trip requirements of exporting DG, but this is likely unnecessary. Multimode Inverters in a Parallel Non-Export DG configuration will need to comply with the Companies fast trip requirements depending on configuration of the customer isolated loads.

Non-Export DG, with its load reduction, may add TrOV effects on circuits with high penetration of exporting DG systems that have not implemented mitigations. This results from an increase in circuit-level reverse power flows during peak PV generation due to decreased load from the Non-Export DG installations. This increase is incremental compared with exporting DG, as discussed in Section 5.4.

---

## 5.3 RULE 14H AND NON-EXPORT IMPLEMENTATION

The proposed modifications to Rule 14H require non-export DG installations with or without energy storage to undergo technical review by the Companies to obtain approval for interconnection. Parallel operation of a DG facility with the distribution system is the fundamental qualifying factor in determining the level of technical review screening for any DG facility. Rule 14H applies to customer generating facilities that operate in parallel or have the potential to operate in parallel with the distribution system. If a DG facility is not designed to operate in parallel with the distribution system, it is not subject to the Rule 14H review process.

Interconnected exporting DG facilities (e.g., PV, wind) that do not incorporate energy storage must operate in parallel with the distribution system. Non-Export DG can be configured for non-parallel operation, as shown in **Figure 5-1**. Non-Export DG can power customer loads when the utility is operational and can provide backup power in a manner similar to that of an uninterruptible power supply to a set of isolated customer loads.

If a DG system is designed to operate in parallel, it is subject to the full screening of Rule 14H, whether it is Non-Export DG, Parallel Non-Export, SIA, FIT, or PPA or if it incorporates energy storage. The Rule 14H screening process may require a supplemental review on circuits above 75% of gross daily minimum load (GDML), depending on the aggregate DG capacity installed on a line section. This could lead to an Interconnection Requirements Study (IRS), depending on the DG installation capacity, percentage of GDML penetration, and line capacity of a given circuit. Systems that are designed to operate in parallel must be reviewed by the Companies to ensure safe and reliable operation of the electric system. An example of a DG system that incorporates energy storage, but is designed to operate in parallel, is shown in **Figure 5-2**. The only difference between this system and the system depicted in **Figure 5-1** is that the system in **Figure 5-2** may export power to the distribution system.

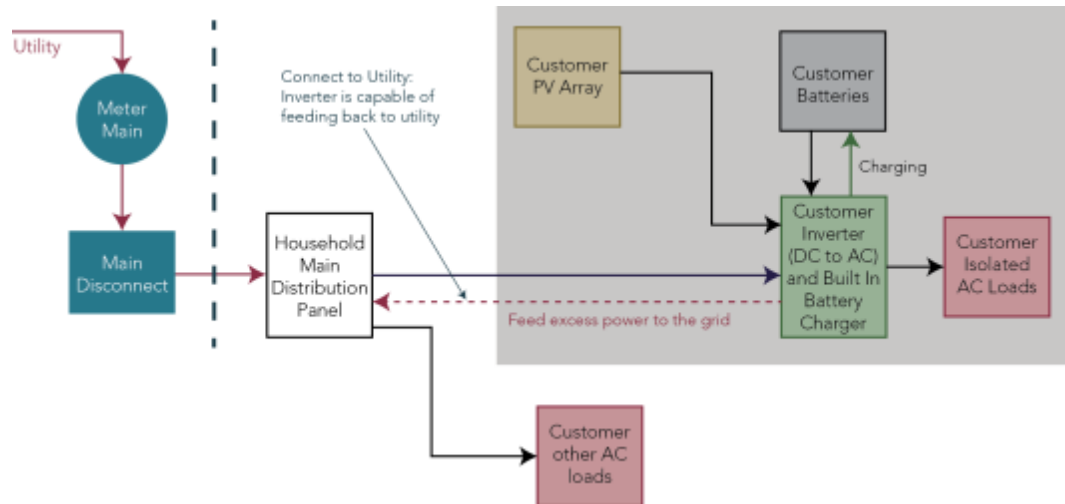

Figure 5-2. PV System with Energy Storage Designed for Parallel Operation

Non-Export DG system that has the potential to operate in parallel (i.e., interconnected) will be approved for interconnection, provided that the Non-Export DG system incorporates protections to prevent reverse power flow. It needs to pass until Screen 3 or Screen 4 of the Initial Technical Review Process to verify its design and potential to operate in parallel with the Distribution System. Subsequent to initial technical review screening, the Companies will not require a supplemental review or an IRS as a condition for interconnection in either of these scenarios.

## 5. Non-Export Distributed Generation System

### 5.3 Rule 14H and Non-Export Implementation

Non-exporting DG systems with energy storage that are not designed to operate in parallel and have no potential to do so are not subject to interconnection review under Rule 14H. Docket 2014-0130 requires that this type of DG facility be registered with the Companies. An example is a Stand-Alone inverter or a battery charger that is not capable of exporting power or operating in parallel with the distribution system.

Docket 2014-0130 focuses on parallel operation as the binary criterion for expedited interconnection approval of non-export systems, but does not consider energy storage or the non-exporting functionality as a criterion. It also does not differentiate a Parallel Non-Export DG system with energy storage from a typical exporting DG system. Based on Docket 2014-0130, Non-Export DG systems with Multimode Inverters may be subject to full screening for interconnection approval, including circuit penetration limits and potentially an SR and IRS. This reduces customer options for expedited interconnection approval. Non-parallel operation limits the customer to offsetting a limited set of their loads and eliminates the possibility of integration of a home energy management system to manage non-exporting DG with customer load. Customer energy storage systems, when integrated with a Non-Export DG system that utilizes a Stand-Alone inverter, could never be used by the utility to provide grid support functions if such systems were permitted to minimally export under utility control.

While Docket 2014-0130 allows for expedited interconnection of Non-Export DG, the Companies recognize the current and potential future benefits provided by Multimode Inverters and energy storage in Non-Export DG installations. Utilities in California and other countries are developing policies about non-exporting DG. The Companies will leverage the body of work that has been done by other utilities and commissions and will consider advantages of Parallel Non-Export DG with energy storage (compared with exporting DG and Non-Exporting DG) during the proceedings for Docket 2014-0130 (e.g., giving preferred interconnection queue status to Parallel Non-Export DG with energy storage).

After approval of Docket 2014-0130, the Companies plan to accept applications for non-export DG; this is not contingent on development of a separate rate structure for non-export DG. The Companies will consider development of a dedicated rate structure for non-exporting DG in parallel and in coordination with other DG-related rate restructuring. The Companies will take a proactive approach to customer outreach to educate customers about Non-Export system sizing, energy storage, design considerations, and contractor selection. The Companies will develop a field verification program to verify non-export commissioning and to further expand the Companies' knowledge base and familiarity with Multimode and Stand-Alone inverter systems and customer-sited energy storage.

## 5.4 GRID IMPACTS AND BENEFITS

Technical and economic impacts on the circuit and system levels must be considered with Non-Export DG. Depending on the conditions under which the Companies implement Non-Export DG with respect to rate structures, Non-Export DG does have the potential to displace exporting DG installations. While this should be considered in the interest of treating all forms of generation equitably, it must also be weighed against circuit upgrade costs and system reliability constraints.

### 5.4.1 Circuit Penetration

The load offset from non-export systems will affect circuit penetration calculations and will increase the reverse power flow on circuits with high penetration. The key differentiator between exporting DG and Non-Export DG with respect to circuit penetration is that the load offset from implementing Non-Export DG is less than the increase in reverse power flow from implementing exporting DG. This allows the integration of more customers and renewable capacity onto the electric system under circuit limitations. This is best illustrated by an example calculation considering Non-Export DG on an example residential circuit.

The circuit penetration level is expressed as a ratio of the DG capacity and the gross daily minimum load (GDML) for a given circuit.

#### Circuit Penetration Level = DG Capacity/GDML

The Companies have provided data that show that the maximum average daytime load for residential customers is approximately 1.2 kW. While the average daytime minimum load may be lower than this, this load is consistent with what has been used in Section 3 to model circuit upgrade costs considering Non-Export DG. Consider an example circuit with a GDML of 1,000 kW and 1,200 kW of exporting DG, resulting in a circuit penetration of 120%. If the circuit penetration limit is assumed to increase to 150% of GDML (rated DG capacity increases to 1500 kW, GDML remains unchanged) the available capacity for exporting DG on this example circuit would be 300 kW.

The average system size of exporting and Non-Export DG is assumed to be approximately 6 kW based on historical NEM installation data provided by the Companies. Based on this assumption and the available capacity calculated above, this circuit could accommodate 50 exporting DG installations to reach a circuit penetration of 150%.

In the Non-Export DG case, there is no increase in DG capacity, but the load is reduced; therefore, for each Non-Export DG system, the GDML is reduced by 1.2 kW. To illustrate

## 5. Non-Export Distributed Generation System

### 5.4 Grid Impacts and Benefits

how the circuit penetration level would increase if the same 50 installations are Non-Export DG, the resulting circuit penetration is calculated as follows. The load reduction from 50 Non-Export DG installations is 60 kW:

$$\text{Circuit Penetration Level} = 1,200 \text{ kW} \div (1000 \text{ kW} - 60 \text{ kW}) = 128\% \text{ of GDML}$$

Using this logic with Non-Export DG, the GDML would need to be reduced to 800 kW from 1000 kW to achieve a 150% circuit penetration.

$$\text{Circuit Penetration Level} = 1200 \text{ kW} \div 800 \text{ kW} = 150\% \text{ of GDML}$$

Because the difference in GDML is 200 kW and using 1.2 kW of load offset per Non-Export DG installation, this example circuit could accommodate approximately 166 Non-Export DG installations at 6 kW each. While the maximum circuit penetration threshold remains the same in both cases, the number of customers that could install renewable generation increased by a factor of 333%. This example also illustrates that Non-Export DG increases the capability of the Companies to achieve renewable integration targets under circuit limits, while minimizing the impacts of reverse power flow.

While the companies cannot disallow a Non-Export DG system from interconnection after passing the initial technical screening, circuit limitations do apply to Parallel Non-Export DG with energy storage and SIA systems. The Companies are concerned that with wide adoption of Non-Export DG, circuit penetrations could exceed acceptable levels with respect to transient issues or circuit upgrades. System planning and interconnection policy must consider the system reliability and circuit impacts resulting from exacerbation of issues caused by existing DG excess generation, because Non-Export DG systems are not subject to circuit GDML limitations.

#### 5.4.2 Excess Generation

Excess generation from exporting DG changes the load profile that the Companies must follow with conventional generation. Excess DG without sufficient load to absorb it reduces system resiliency, because conventional generation must ramp down, which reduces its operational efficiency and capability to respond to contingencies. Utility control of exporting DG systems will mitigate excess generation and require advancements in inverter technology, as well as development of interactive modern grid features, to allow active curtailment of exporting DG. Non-Export DG does potentially introduce additional load variability, which is inherent in all inverter-based DG, and does increase net excess generation from existing exporting DG, causing a system operational and reliability issue. However, as shown in Section 5.4.1, the contribution to excess generation, based solely on the reduction in aggregate load, is not the same order of magnitude as with exporting DG. Advancements in inverter technology and grid

modernization will allow the Companies to limit excess generation from exporting DG. Commercial agreements and rate structures will need to be defined to compensate customers for operational and economic curtailment, and customers will invariably balance such compensation with options to install Non-Export DG.

DG (exporting and SIA) interconnection requirements for frequency ride-through has led to under-frequency load shedding conditions during system disturbances due to the loss of a large conventional generation unit. Docket 2011-0206 requires frequency ride-through for exporting DG inverters, which will reduce the impact of DG on under-frequency load shedding and increase system reliability compared with existing inverter ride-through capabilities. The Companies have expanded these requirements in the Second Stipulation to that docket, which specifies that inverters are to trip offline at 57 Hz and 63 Hz<sup>50</sup>. Non-Export DG operates differently from exporting DG: during under-frequency conditions, the isolated customer loads are separated from the power grid and are not seen by the event. If, during an under-frequency event, the non-export inverter is drawing power from the grid to supplement isolated customer loads or to charge batteries, these loads are disconnected from the grid, effectively creating customer-based load shedding. The Companies are concerned that having inconsistent frequency and voltage trip settings across the DG portfolio may create relay coordination issues, and, while customer-based load shedding can be beneficial, the Companies will maintain consistency for frequency and voltage trip requirements for all inverters, including Non-Export DG. The Companies may optimize this at a later date through analysis and coordination studies.

### 5.4.3 Load Reduction

Both exporting and Non-Exporting DG reduce load on the distribution system. Load reduction from Non-Export DG differs from that of exporting DG because the load reduction can be spread over a 24-hour period, depending on the size of the energy storage system. Rate structures can be developed to provide Non-Export DG customers with incentives to reduce their load significantly during the evening peak system load periods. While Non-Export DG effectively provides customer load shifting, it should not be assumed that Non-Export DG will offset customer peak usage. System planning must consider that, while system demand is reduced, there must be peaking capacity available to maintain system reliability.

---

<sup>8</sup> Docket 2011-0206, Instituting a Proceeding to Investigate the Implementation of Reliability Standards for Hawaiian Electric Company, Inc., Hawai'i Electric Light Company, Inc., Maui Electric Company, LTD., Second Stipulation Regarding Work Products Submitted Part of the January 18, 2013 Final Report of the PV Sub-Group For the Reliability Standards Working Group, Filed June 12, 2014



## 5. Non-Export Distributed Generation System

### 5.4 Grid Impacts and Benefits

Non-Export DG masks customer load, which can affect real-time generation dispatch. The Companies will implement in their interconnection review and approval processes a means to ensure that Non-Export DG installations will be tracked. When AMI becomes available on a system-wide, gathering data on these systems will facilitate generation dispatch. Reductions in excess generation achieved by integrating Non-Export DG instead of exporting DG may facilitate higher utilization of lower cost utility-scale renewables; however, the reduction in load could offset this benefit, depending on the mix of exporting and Non-Exporting DG and on how customers use their energy storage systems. As more renewables are integrated, system planning and policy will need to consider the cost-benefit of all generation assets to customers relative to projected system loads.

#### 5.4.4 Black Start Recovery

The Companies are concerned that with high penetration of Non-Export DG, the additional battery charging load that the system could experience during recovery from an extended, system-wide blackout could affect system restoration efforts. This case may occur after an extended grid outage, provided the outage was during a period with low or no DG output, whereby a large quantity of the Non-Export DG systems could then require grid power to charge batteries. Although this condition is possible, it is unlikely that the nameplate capacity of all Non-Export inverters would be used to charge batteries. It should be noted that Non-Export DG inverters (Multimode or Stand-Alone), must satisfy the grid synchronization requirements of IEEE 1547 and UL1741 (i.e., grid frequency and voltage must be within specific parameters and not induce a grid disturbance upon reconnection). Multimode Inverters offer functionality to delay battery charging from the grid following an outage. With such features and knowledge of where Non-Export DG are located through the Companies' tracking in their interconnection review processes, the risk to system restoration can likely be mitigated. The Companies will not prohibit battery charging from the grid and will further study this scenario to assess if additional requirements on Non-Export DG inverter reconnection times should be required.

#### 5.4.5 Distributed PV Variability

Exporting PV systems exhibit variability in output because of cloud patterns and irradiance fluctuations. While variability decreases significantly with spatial diversity (i.e., island-wide variability is significantly less than the variability of a single system), these variations can be significant in island climates. The variability of the entire DG portfolio on a given island is far less than the variability of one DG system. NREL collected high-resolution irradiance data from Oahu for a 12-month period, from 2010 to

2011. **Figure 5-3** shows a day of extreme irradiance variability when measured on a 2-second time scale. Power output is proportional to irradiance.

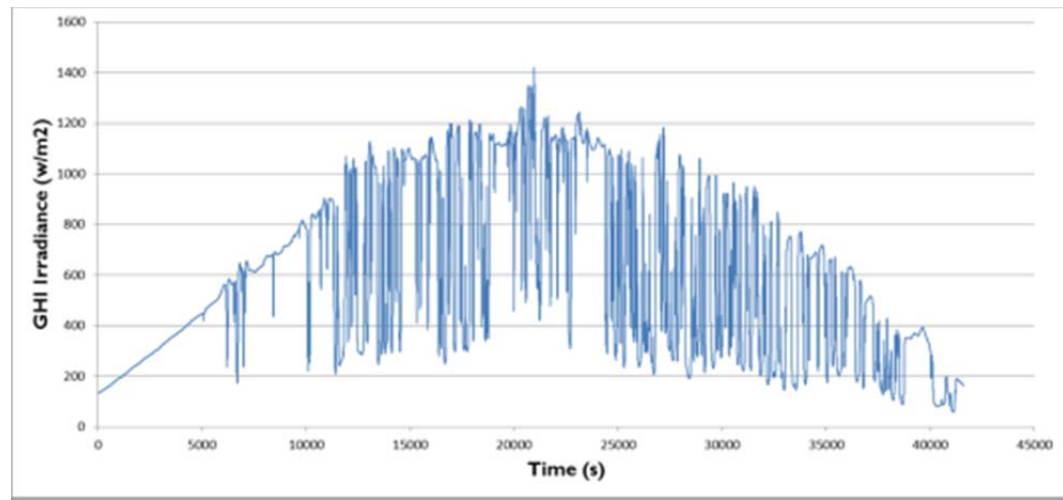

Figure 5-3. Oahu Irradiance Variability Measured on 2-Second Time Scale (NREL)

Non-Export DG eliminates the variability inherent in distributed exporting PV, which the Companies currently manage at the system level. During the day, the Non-Export DG system offsets customer loads, and all the excess is used to charge batteries or is curtailed by the non-export inverter, resulting in a steady profile, compared with the range shown in **Figure 5-3**. While there likely will be changes in customer load profiles as energy stored during the day is used to offset peak residential customer usage in the evening, this can be mitigated to some extent through market signals and rate structures.

---

## 5.5 NON-EXPORT IMPACT ON CIRCUIT UPGRADES

The Distributed Generation Interconnection Capacity Analysis (DGICA) finds that significant circuit upgrades are required to accommodate the high levels of reverse power flow during peak DG generation. The DGIP estimates the base case cost of these upgrades to the Companies is approximately \$195 million, assuming 901 MW of distributed generation with no active DG output control across the Companies. At the circuit level, Non-Export DG mitigates the impacts of reverse power flow and the associated upgrades. While some service-level upgrades may be more cost-effective than Non-Export DG with energy storage, depending on the cost allocation structure, circuit reconductoring costs are prohibitive, even when distributed across many customers. When Non-Export DG is considered in the generation portfolio at 50% and 100% of the projected residential DG capacity through 2030 the distribution system cost upgrades can potentially be reduced by approximately \$53 million and \$137 million respectively as detailed in **Table 3-10**. On circuits with high penetration levels, significantly higher levels

## 5. Non-Export Distributed Generation System

### 5.6 Non-Export Rate Structure

of renewable integration are possible when Non-Export DG is used before reaching the distribution system's thermal limitations, providing more customers with the option to self-generate and reduce their electricity costs. Additional details of this analysis are presented in Section 3.

---

## 5.6 NON-EXPORT RATE STRUCTURE

The Companies are concerned that their assets and infrastructure will be used as standby power resources for interconnected Non-Export customer generators that would otherwise be capable of providing primary power to the site. Current rate structures do not specifically contemplate Non-Export DG systems with respect to fixed cost allocations and utility cost recovery related to how a Non-Export DG customer uses grid electricity. When properly designed, a Non-Export DG system uses grid power as a supplementary source of electricity, rather than as a primary source. While the Companies do not intend to specify customers' Non-Export DG system design with respect to the size of the energy storage system, this design can be driven by market signals through an effective Non-Export DG rate structure.

Issues to be addressed in the design of a Non-Export DG rate structure will include a consideration that Non-Export DG customers be compensated for their overall reduction in use by tiered rates that account for reduced usage and that there be increased charges for customers who ultimately do not significantly reduce their usage.

Provisions of a Non-Export DG rate structure could include a monthly standby charge, tiered rates for energy consumption to supplement customer load, and provisions to remove a customer from the Non-Export DG rate structure above certain energy usage thresholds. The latter provision is intended to provide incentives for customers to not significantly undersize systems to gain a favorable rate structure versus the potential future DG customer rate structure. The monthly standby charge, similar to demand charges for certain customer should appropriately allocate the cost of system resources needed to reliably supply grid power if a Non-Export DG system is taken offline. The Companies will develop a Non-Export DG rate structure be addressed in a future docket, with the rate design recommendations identified in Section 6.

The potential for customer-sited energy storage to provide grid support services, such as frequency and voltage regulation, should also be considered in a future docket. Energy storage systems associated with Non-Export DG can potentially be used to provide grid support functions (provided such systems were permitted to export under utility control i.e. parallel operation), and a rate structure must to be developed to consider the non-export functionality and the provision of grid support services. As the Companies

modernize the grid and advanced inverter functions and control become available, the Companies will engage with industry, the standards bodies, and relevant stakeholders to consider the compensation mechanism for providing utility-controlled grid support services from Non-Exporting DG systems. A DG facility with energy storage that exports energy for grid support services can also be non-exporting during periods when grid support services are not required.

---

## 5.7 NON-EXPORT TECHNOLOGY DEVELOPMENT

Non-Export DG (with Stand-Alone Inverter) as defined herein cannot provide grid support services. Parallel Non-Export DG, if permitted to minimally export only under utility control, could provide grid support services from the energy storage systems that could accompany a Parallel Non-Export DG system. Reverse power flows on highly penetrated circuits must be considered during the interconnection review process and during operations to allow limited provision of active power grid support services. Grid support service capability for small-scale DG facilities will necessitate advancements in inverter communications and control capabilities, as well as development of smart-grid and utility-control systems, to integrate the distributed storage resources for this purpose as discussed in Section 4. In addition, commercial considerations for interconnection agreements and tariffs must be developed to compensate non-export DG customers for providing grid support services. This would represent a class of customer-sited energy storage that is different from that of the Non-Export DG system discussed here.

As discussed in Section 5.2.1, Stand-Alone Inverters used in Non-Export DG systems cannot interact with the grid. Multimode inverters are available today that could be controlled by the utility if such systems were in place. The future of technology development for Non-Export DG and utility control will depend on the adoption of Parallel Non-Export DG with energy storage and the advancement of inverter technology, grid modernization, and adoption of energy storage systems with Parallel Non-Export DG systems. Energy management systems can further maximize the value of Parallel Non-Exporting DG systems with energy storage and could potentially be incorporated into customer demand management programs.

**5. Non-Export Distributed Generation System**  
5.7 Non-Export Technology Development

This page intentionally left blank.

# 6. Cost Allocation and Rate Reform

## 6.1 OVERVIEW

The Commission has ordered the Companies to identify potential ways to pay for the improvements identified in the DGIP. As part of the Distributed Generation Interconnection Capacity Analysis (DGICA), the Commission’s Order requests:

*“ii. Development of recommended circuit upgrade requirements, including associated costs and ratepayer impacts, to enable circuit penetration limits to be increased in a logical, step-wise manner.”*

As part of the Distribution Circuit Improvement Implementation Plan (DCIIP), the Order also requests:

*“iv. Proposals for addressing the cost allocation issues associated with who bears responsibility for system upgrade costs.”*

This section highlights the following:

- Types and magnitudes of the costs associated with DGIP
- Options to equitably allocate the cost of future DG interconnections
- Challenges presented by the NEM program in its current form and solutions to address those challenges.

## 6.2 COST ALLOCATION

The Commission's Order requested that the Companies recommend specific cost allocation methods for recovering the costs of the DGIP. The Companies have considered a number of means for allocating these costs equitably and fairly.

The choice of a final method will require balancing two competing objectives: ensuring these costs are allocated to the cost-causing DG customers, while recognizing that many aspects of DG provide system and public benefits, and thus some costs associated with enabling DG must be socialized across the Companies' rate base.

To this end, the Companies recognize that many of the specific costs attributable to implementation of the DGIP can be viewed as system-level upgrades, which benefit all customers, with some exceptions. The Companies believe the appropriate method for allocating and recovering these costs is to examine each for its ability to provide either system benefits, in which case it may be included in base rates, or its ability to provide benefits only to DG customers, in which case it may need to be captured in DG customer-specific rates. For example, the Load Tap Changer (LTC) controller replacements, circuit-upgrade programs, and substation transformer upgrades are all improvements that are expected to relieve constraints on reverse power flow due to DG on circuits and substations. .

Another example of this approach is the treatment of costs related to interconnection request studies (IRs), which may be necessary for specific DG interconnect applications. The Companies acknowledge that there have been many recent studies of this nature. By using the results of these prior studies, the Companies have developed an approach in this document that will avoid the need for future studies for the majority of current and future interconnection requests. However, if the current system size limits remain the same, the Companies expect that some requests will require additional studies, depending on the size of the requested system, as well as on the penetration levels of its associated circuit.

The Companies believe it may be appropriate to consider implementation of a one-time interconnection charge to recover the costs of these potential future IRs, in addition to other DG-related costs identified below. In addition to other DG-related costs identified below, transformer upgrades due to the level of DG connected to those transformers may also be considered a "DG-related" cost. While each incremental DG connection may not trigger a circuit upgrade, many of these upgrades are required because of the aggregate DG systems connected to them and the costs of these transformers should therefore be borne by DG customers. The Companies have considered this potential interconnection charge as a feasible method for recovering the DGIP costs.

**Table 6-1** below identifies the estimated capital expenditures required to implement the DGIP, which are approximately \$194.5 million. This includes \$182.5 million for Hawaiian Electric, \$6.3 million for Maui Electric, and \$5.7 million for Hawai'i Electric Light.

Mitigation Measure	Hawaiian Electric	Maui Electric	Hawai'i Electric Light	Company Total
Regulator	\$110,000	\$66,000	\$132,000	\$308,000
LTC	\$770,000	\$498,000	\$374,000	\$1,642,000
Reconductoring	\$75,588,700	\$0	\$0	\$75,588,700
Substation	\$51,975,000	\$316,000	\$2,475,000	\$54,766,000
Distribution Transformer	\$16,475,175	\$1,072,262	\$1,603,439	\$19,150,877
Primary Laterals	\$37,501,200	\$4,422,000	\$1,122,000	\$0
Grounding Transformers	\$110,000	\$66,000	\$132,000	\$43,045,200
<b>Total</b>	<b>\$182,420,075</b>	<b>\$6,374,262</b>	<b>\$5,706,439</b>	<b>\$194,500,777</b>

Table 6-1 Total DGIP Costs by Island for Each Mitigation Measure

The Commission's Order requested that the Companies recommend specific cost allocation methods for recovering the costs of the DGIP. The Companies have evaluated a one-time interconnection charge as one potential method for recovering DGIP related capital requirements from DG customers. The methodology described below illustrates the magnitude of a potential one-time interconnection charge which may apply to new DG customers. The Companies acknowledge that this methodology is merely illustrative and does not represent any specific recommended charges or rate base increases; proposed rates and charges will require a comprehensive evaluation, determination, and approval in the proceeding initiated by Order No. 32269, issued by the Commission on August 21, 2014.

The potential one-time interconnection charges were estimated using a methodology that captures cost causation principles, as well as recognizing that before 2017, it will be infeasible and unreasonable to charge DG customers retroactively for their share of the DGIP costs.

The estimates begin with the assumption that current DG customers and customers who install systems before tariff reform is enacted cannot be retroactively charged for the impact of their DG systems on the circuit. Nonetheless, their systems have necessitated—and will continue to necessitate—circuit and system upgrades. Rather than allocate the total estimated future upgrade costs to *new* DG customers, a portion of those future costs were allocated to rate base for the purposes of this estimation exercise.

The interconnection charge and rate base estimates include DG capacities as of the end of year 2016. The end of year 2016 MW levels were subtracted from the end of year 2030



## 6. Cost Allocation and Rate Impacts

### 6.2 Cost Allocation

MW levels to obtain an estimate of the incremental DG MW installed in the period. This incremental DG capacity was then used to calculate the estimated fixed interconnection charges in dollars per installed kilowatts. The incremental MW for each island for 2017 through 2030 is identified in the tables as “Incremental DG.”

The methodology further assumes that new DG customers, beginning in 2017, will pay a fixed interconnection charge that reflects their portion of the total estimated DGIP upgrade capital of \$194.5 million, identified in the tables for each island as “Total DGIP capital.” The estimated interconnection charges for each island are identified in the tables as “Interconnection Charge.”

Having calculated the dollars per installed DG kilowatt, the Companies then multiplied this value by the Incremental MW for each island to estimate the Interconnection Charges identified.

Finally, the estimated Rate Base Capital is calculated by subtracting the Interconnection Charges from the total DGIP capital for each island.

**Tables 6-2** through **6-2b** summarize by island the preliminary estimates of costs and potential interconnection charges. The Companies note that these estimates are meant for illustrative purposes only, and that the final design and approval of any potential rates and charges will require a separate the proceeding initiated by Order No. 32269.

Table 6-2 identifies the total DGIP costs by island for each mitigation measure.

Hawaiian Electric		DG(1)
End of year 2016 DG	MW	246
End of year 2030 DG	MW	484
Incremental DG	MW	238
Total DGIP Capital <sup>(2)</sup>	\$	182,420,075
Interconnection Charge <sup>(3)</sup>	\$/kW	377
Interconnection Charge <sup>(4)</sup>		89,813,085
Rate Base Capital <sup>(5)</sup>		92,606,990
(1) Includes 54 MW FIT capacity (2) Excludes Technology Demonstration costs. Calculations assume that all costs before 2017 are included in rate base. All costs are shown in current dollars (3) Calculated for full, EOY 2030 DG MW (4) Calculated using \$/kW x Incremental DG MW. Totals include rounding of DG MW and Interconnection Charges \$/kW. (5) Total DGIP Capital less Interconnection Charges		

Table 6-2. Hawaiian Electric DGIP Costs by Island for Each Mitigation

Maui Electric		DG (1)
End of year 2016 DG	MW	72
End of year 2030 DG	MW	106
Incremental DG	MW	34
Total DGIP Capital <sup>(2)</sup>	\$	6,374,262
Interconnection Charge <sup>(3)</sup>	\$/kW	60
Interconnection Charge <sup>(4)</sup>	\$	2,028,838
Rate Base Capital <sup>(5)</sup>	\$	4,345,425
(1) Includes 2 MW FIT capacity (2) Calculations assume that all costs before 2017 are included in rate base. All costs are shown in current dollars (3) Calculated for full, EOY 2030 DG MW (4) Calculated using \$/kW x Incremental DG MW. Totals include rounding of DG MW and Interconnection Charges \$/kW. (5) Total DGIP capital less interconnection charges		

Table 6-2a. Maui Electric DGIP Costs by Island for Each Mitigation

## 6. Cost Allocation and Rate Impacts

### 6.2 Cost Allocation

Hawai`i Electric Light		DG (1)
End of year 2016 DG	MW	69
End of year 2030 DG	MW	104
Incremental DG	MW	35
Total DGIP Capital <sup>(2)</sup>	\$	5,706,439
Interconnection Charge <sup>(3)</sup>	\$/kW	55
Interconnection Charge <sup>(4)</sup>	\$	1,924,991
Rate Base Capital <sup>(5)</sup>	\$	3,781,449
<p>(1) Includes 1 MW FIT capacity</p> <p>(2) Calculations assume that all costs before 2017 are included in rate base. All costs are shown in current dollars</p> <p>(3) Calculated for full, EOY 2030 DG MW</p> <p>(4) Calculated using \$/kW x Incremental DG MW. Totals include rounding of DG MW and Interconnection Charges \$/kW.</p> <p>(5) Total DGIP capital less interconnection charges</p>		

Table 6–2b. Hawai`i Electric Light DGIP Costs by Island for Each Mitigation

---

## 6.3 RATE IMPACTS OF DG

The Companies value DG as a resource that enables customer choice, contributes to meeting the renewable portfolio standards, and also creates a public benefit by avoiding emissions and other impacts associated with burning fossil fuels. The Companies intend to continue to offer customers choices to manage their energy use. The Companies believe that, to ultimately ensure a sustainable future for DG, it will likely be necessary to revise or eliminate the current NEM program for future DG customers.

The total number of solar PV systems interconnected on the Companies' grids as of December 31, 2013, is approximately 40,000, with a total capacity of 300 MW. Of those installations, 96% take advantage of the NEM program. More than 70% of rooftop systems are on Oahu. With nearly 30,000 PV systems and 221 MW as of December 31, 2013, 10% of Hawaiian Electric customers now have rooftop solar, an appreciably higher percentage than any mainland utility. On the Island of Hawai'i, 7% of Hawai'i Electric Light customers have rooftop solar, and 8% of Maui Electric customers have rooftop solar. The Solar Electric Power Association (SEPA) has confirmed that Hawai'i leads the nation in the amount of PV penetration per capita – more than triple the amount of the next state (Hawai'i 16.9, Arizona 4.3, California 4.2, and Colorado 2.9 installations per 1,000 people). **Figure 6-1** provides the percent penetration by specific program (e.g., NEM, FIT, SIA) as of December 31, 2013, for each system.

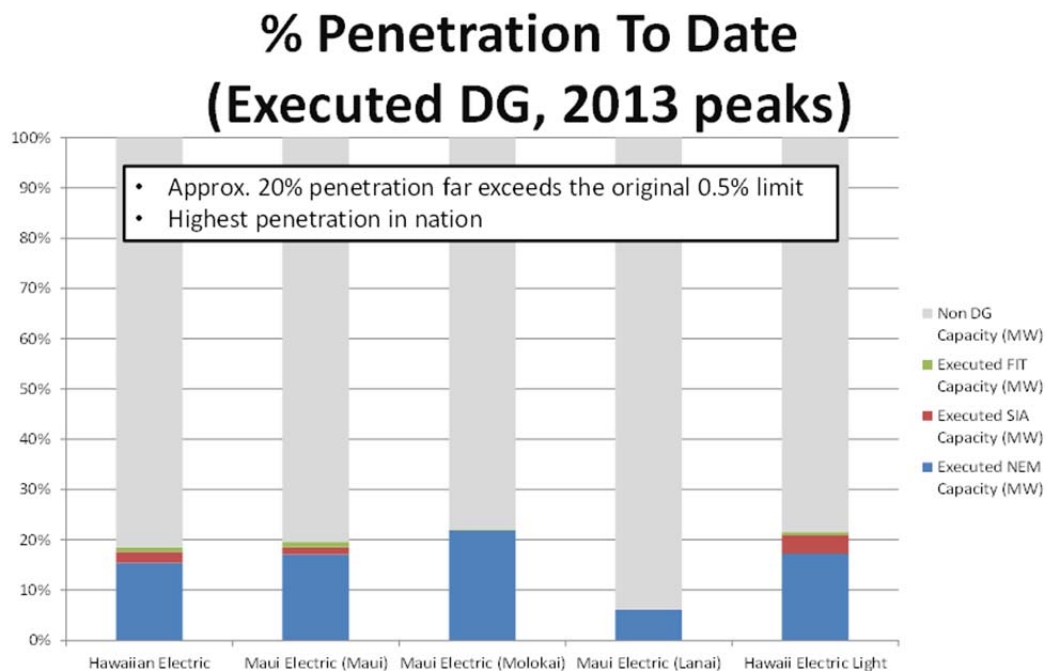

Figure 6-1. Percentage Penetration to Date

The levels of DG are so high in Hawai'i that this resource is essentially squeezing out room on the Companies' grids for other lower cost utility-scale projects that provide the same environmental benefits but have increased economic benefits for all customers.

Figure 6-2 provides a representation of the price per kWh by renewable resource investment, including NEM. As shown, the NEM program is by far the largest and most expensive of the renewable energy resources when compared with the other Companies' contracts.

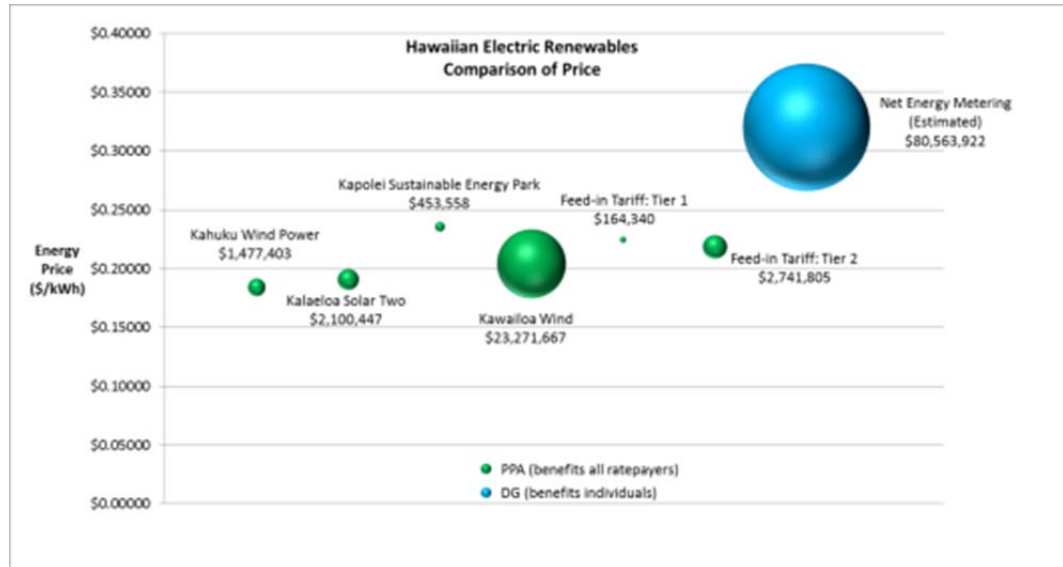

Figure 6–2. Hawaiian Electric Renewables Comparison of Price

In addition to the rate equity issues related to the NEM program, the Companies are concerned that, ultimately, NEM will prevent the Companies from procuring lower cost energy from other forms of renewable energy, such as utility-scale solar and wind and, potentially, geothermal facilities. In the long term, increased participation in the NEM program will reduce the opportunity for other forms of transmission-connected generation. These facilities have economies of scale related to their large size, which can provide lower cost energy to all customers, but potentially will be displaced by DG NEM systems, which typically do not extend those economic benefits to all customers.

By statute, NEM was intended to be offered on a “first-come-first-served basis” until the total rated generating capacity produced by eligible customer-generators equals 0.5% of the electric utility’s system peak demand. However, this cap was steadily raised over time as part of the Commission’s investigative docket on NEM, Docket No. 2006-0084. The Commission released its most recent decision related to NEM caps January 13, 2011, in which, among other things, it approved a stipulation filed January 7, 2010, between the Companies and the Consumer Advocate to eliminate NEM system-wide caps and replace them with a 15% of distribution circuit peak load threshold for DG penetration. The Companies believe that the intent of the NEM program at its inception, in combination with federal and state incentives, was to nurture a developing technology and industry, because the cost to self-generate clean renewable energy was prohibitive. However, as PV system costs have decreased dramatically during the last several years, the cost of PV generation has decreased to a level where utility-scale projects are able to bid at all-in rates below 17¢/kWh, much lower than the retail rate that NEM customers are receiving. The need to provide retail compensation for DG no longer exists.

## 6. Cost Allocation and Rate Impacts

### 6.3 Rate Impacts of DG

For the Companies, there is currently no system cap for NEM generators. As mentioned above, the system cap was replaced with a per-circuit cap of 15% circuit peak in the NEM Docket. As a matter of practice, however, the Companies have attempted to keep pace with customer demand and have interconnected NEM systems well beyond the 15% circuit peak threshold for many circuits, based on technical reviews and information known to the Companies at the time of the installation. As of the date of this report, the NEM program penetration has grown to a level 60 times that originally envisioned when it was capped at 0.5% of system peak.<sup>51</sup>

NEM potentially creates cross-subsidization among customer classes by reducing or eliminating DG customers' contributions toward fixed costs by reducing or eliminating their kWh sold, which is how base rates currently recover fixed costs associated with generation, transmission, distribution, and customer service in the residential and small commercial classes. The Companies believe that NEM pricing at full retail rates represents an embedded subsidy to PV systems, a view that is shared by many utilities in the United States and worldwide.

Other than fuel and purchased energy, the costs of generating, transmitting, distributing, and managing electricity over a complex electric system are primarily fixed, representing long-term commitments of capital to build and maintain facilities. However, these fixed costs are recovered mainly from residential and small commercial customers and, to a lesser extent, large commercial customers through a volumetric charge (i.e., kWh usage varies on energy consumption). In such a rate design, the more energy a customer consumes, the higher the kWh charge, the higher the electricity bill, and the higher the contribution to fixed costs; the fewer kWh consumed, the lower the bill, and thus, the lower the contribution to fixed costs. The residential and small commercial customer classes do not have demand charges and recover over 85% and over 65% of fixed costs, respectively, through the volumetric (energy) charge. In Hawai'i, with the advent of NEM, customers who self-generate are able to reduce their net energy usage, thereby, reducing their volumetric charges and their contribution to the fixed costs associated with safely and reliably operating and maintaining the entire system. This phenomenon shifts a portion of the fixed cost recovery from customers who self-generate to those who do not, as illustrated in **Figure 6-3** and **Figure 6-4**. This cost shifting is an equity issue in rate design.

The Companies reported an estimated annualized lost contribution to fixed costs (cost shift) of \$38.5 million (Hawaiian Electric, \$28.4 million; Maui Electric, \$4.4 million, and Hawai'i Electric Light, \$4.7 million) based on installed NEM capacity as of December 31,

---

<sup>51</sup> This estimate is based on the fact that all islands in the Companies' service territories, with the exception of Lanai, are roughly at 30% of system peak for DG when including installed projects plus pending applications.

2013.<sup>52</sup> Overall, this represents 1.29%<sup>53</sup> of the Companies' reported 2013 year-end revenues, which equals a \$0.0043/kWh<sup>54</sup> increase in rates for the Companies. The Companies also have the ability to use a decoupling mechanism to offset any decline in sales volume. The decoupling mechanism spreads the recovery evenly across all net kWh sold to all customers, with commercial customers absorbing about 70%<sup>55</sup> of the impact. The impact on residential rates attributed to the cost-shift issue to date has not been significant enough to cause a major public reaction. However, an annualized cost shift of \$38 million is large enough to raise an equity issue between those who self-generate and those who do not. This is a public policy issue that must be addressed, especially given the rapid rate at which this absolute cost shift is increasing. The graphical representation of this is illustrated in **Figure 6-3**; from 2008 to 2013 the total lost contribution to fixed cost has increased at a compounded annual growth rate of 122%.<sup>56</sup>

California recently passed AB 327, which allows the CPUC to modify the rate designs of investor-owned utilities to make them more equitable and to reflect the cost of serving customers. Oklahoma recently passed SB1456, which directs the OK PUC to establish a separate DG customer class, which then will pay a form of a fixed monthly surcharge toward the Oklahoma utilities' fixed costs. The Companies have examined these recent legislative efforts to identify aspects that could be adopted for use in Hawai'i.

---

<sup>52</sup> 2013 Net Energy Metering Status Report, submitted to HPUC Jan. 31, 2014.

<sup>53</sup> Hawaiian Electric Industries 2013 Year End earnings report.

<sup>54</sup> 2013 Net Energy Metering Status Report, submitted to HPUC Jan. 31, 2014. This number is based on R, G, J, and P rates divided by 2014 forecast sales.

<sup>55</sup> Hawaiian Electric Industries, Inc. 2013 Statistical Supplement, page 16, commercial customers accounted for 73% of the kWh sales.

<sup>56</sup> 2013 Net Energy Metering Status Report, submitted to HPUC Jan. 31, 2014.



## 6. Cost Allocation and Rate Impacts

### 6.3 Rate Impacts of DG

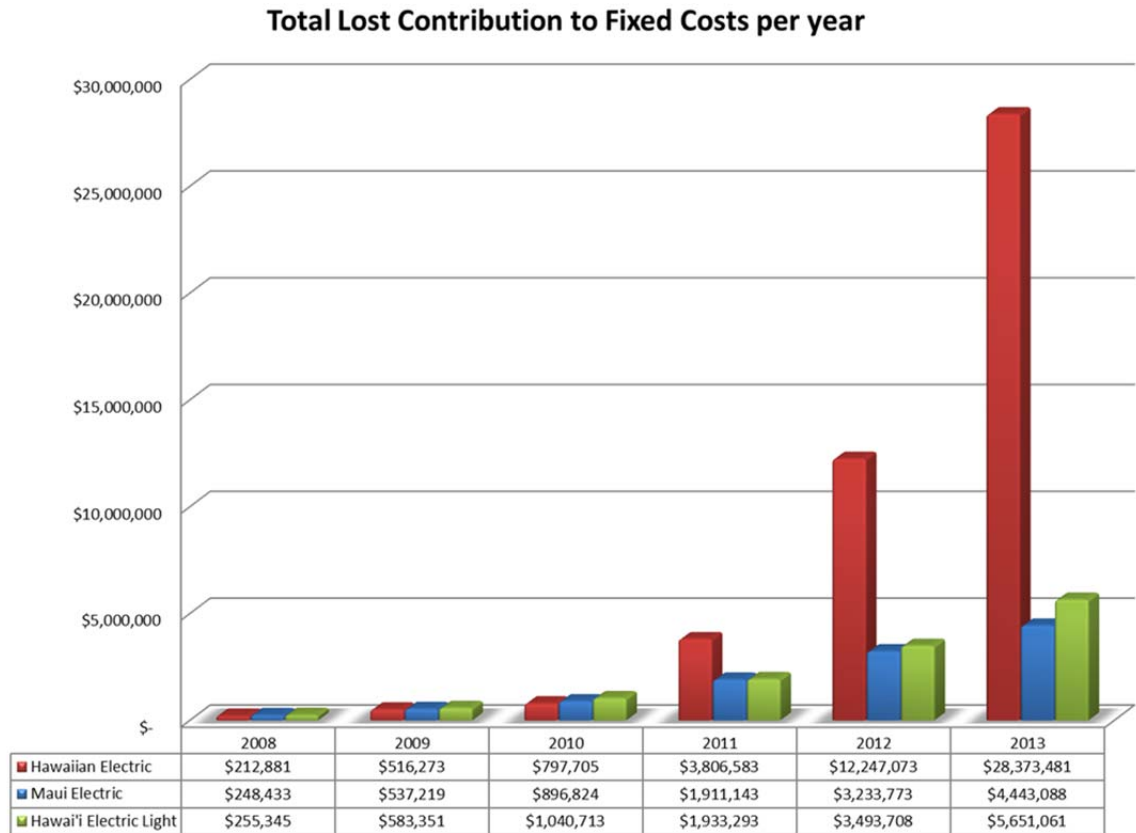

Figure 6-3. Estimated Lost Contribution to Fixed Costs

The aforementioned cost shift translates into higher bills for non-DG customers. From 2008 to 2013, the yearly residential bill impact of the cost shift for a Hawaiian Electric customer who does not self-generate increased significantly, as shown in **Figure 6-4**. Whereas prior to 2010 the estimated annual cost impact to a non-DG customer on Oahu was less than a dollar, in 2013 the impact had increased to over \$31.

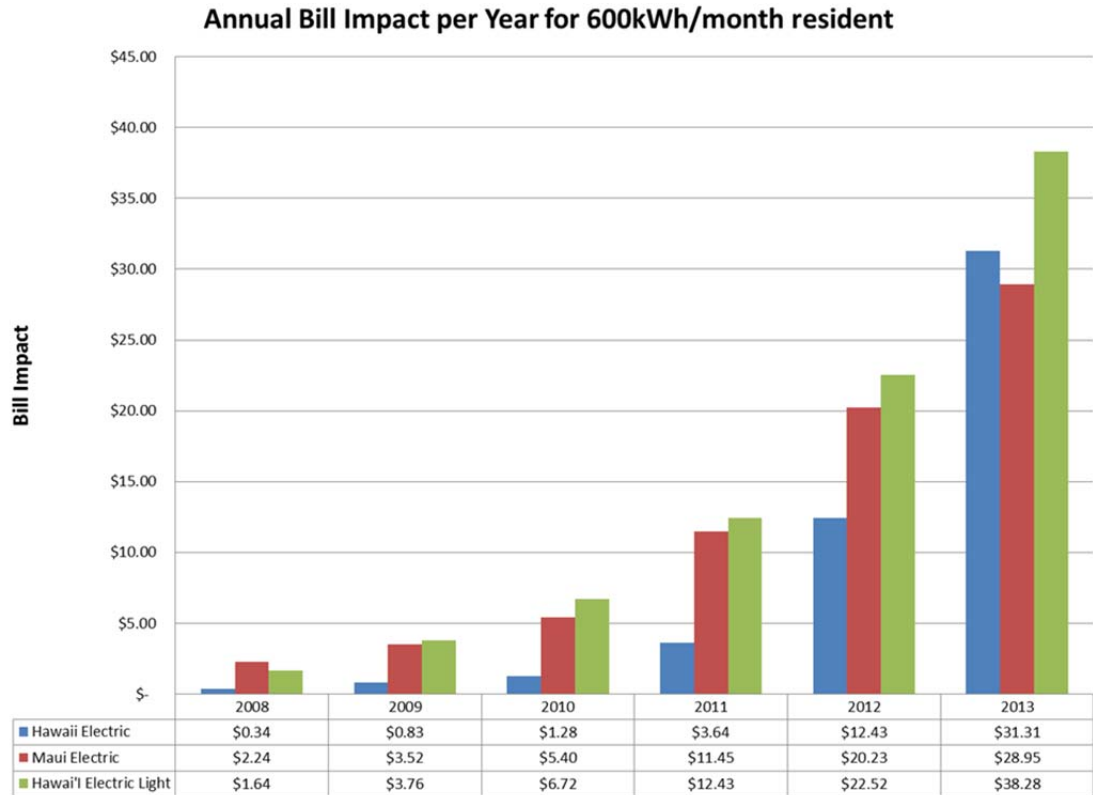

Figure 6-4. Estimated Annualized Impact on Typical Residential Bill of 600 kWh/Month Based on NEM Installations as of Year End

The Companies’ policies, programs, and tariffs, to the greatest extent possible, must be fair to all customers and those who do business with the utilities. Programs that favor one group of residential customer over another or practices that unfairly change the rules of the game on customers must be identified and corrected to strengthen the relationship that the Companies have with their customers. As the Companies move forward with actions to reduce customer costs, advance clean energy, and modernize the grid, a governing principle will be to ensure fairness and to look out for the best interests of all of their customers.

In the traditional utility model, costs are allocated to customers based on the principles of cost causation and equity: the customer pays for costs incurred by the utility to provide service to that customer. This practice should be equally applied to all customers. As the regulatory model has become more complex, with some customers generating portions of their own electricity and growing numbers of independent power producers (IPPs) seeking to sell electricity to the utility, issues have arisen that must be addressed to allow these efforts to continue to thrive, while preserving the goal of equity in rate design to all customers and energy suppliers. The Companies will evaluate their processes to more equitably allocate costs to customers and will support future program reviews, as directed by the Commission.

## 6. Cost Allocation and Rate Impacts

### 6.3 Rate Impacts of DG

The Companies believe that to enable further development of DG in a technically and economically sustainable manner, it will be necessary to significantly revise or potentially eliminate the current NEM program for future DG customers, and to adopt some type of “DG 2.0” program. A partial list of rate options to be considered in the proceeding initiated by Order No. 32269 issued by the Commission on August 21, 2014 includes, but is not limited to:

**Gross Export Purchase** – Customers would be credited for their net DG output to the utility and purchase all of their requirements from the utility. Customers could be credited at a rate determined by market-based proxy (e.g., latest renewable purchase power agreements) or some rate more consistent with wholesale renewable generation costs.

**Schedule Q:** – A modification of the existing Schedule Q tariff could implement the Gross Export Purchase concept in the near term, in a manner similar to that practiced by Kauai Island Utility Cooperative.

**Buy All/Sell All** – Customers would be credited for their entire DG output to the utility and purchase all of their requirements from the utility. Customers could be credited at a rate determined closer to the lower rates, which could be obtained from utility-scale DG.

**Unbundled Rates** – New rate designs which will better align pricing of services with the partial requirements of DG customers, by separating volumetric consumption from potential capacity demands on the grid.

**Time Variant Rates** – Rates designed to encourage customers to switch consumption to daylight periods, decreasing the impact on the dispatch of thermal resources, and reducing the need to curtail lower cost, utility-scale renewable resources

**Fixed Customer Charge Increase** – Increased customer charges to recover the costs associated with benefits to all customers. This option would include the Companies’ filing a Lifeline Program to assist customers in need. This would be a complement to the On Bill Financing and GEMS programs.

**Residential/Small Commercial Demand Charge** – Fixed charge determined by customer peak demand capacity requirements.

**Interconnection Charges** – One-time charges reflecting the costs of grid upgrades required to integrate DG systems

**Capacity Based Surcharge** – Charges associated with the size of a customer’s DG system, meant to recover ongoing costs associated with integrating DG

**Grid Services Charges** – Charges reflecting DG related, fixed grid and generation costs, which may include demand, service, or other surcharges.

The Companies' preference is to transition away from the current NEM program to some form of a Gross Export Purchase program, which includes some combination of interconnection and grid services charges. Acknowledging that it is likely infeasible to affect an immediate switch, the Companies recommend consideration of a transition to a modified Schedule Q tariff, under which customers would be credited for exported energy at wholesale-based rates, rather than retail rates, as is currently practiced by Kauai Island Utility Cooperative. To implement this transition strategy, the Companies would seek re-instatement of the NEM program cap based on percentage of system peak demand or otherwise obtain permission to close the NEM program to new customers, and would seek to modify the Schedule Q tariff to specifically include DG customers and credit them for their exported energy, while continuing to recover the cost of DG energy in rates.

The Companies readily acknowledge that the final design of the Gross Export Purchase rate program will involve several challenges, including the following:

- Consideration of developing a specific methodology and input assumptions for identifying the rate at which customers will be credited for their gross DG exported energy. Reaching consensus on these methodologies and assumptions has been shown to be a very difficult endeavor in many mainland jurisdictions.
- Consideration of rate design that might include implementing a time-variant element, a one-time interconnection charge, and a grid services charge or demand charge to complement the Gross Export Purchase program.
- *Time Variant Rates* – Although the Gross Export Purchase program will be designed primarily to resolve the fixed-cost recovery equity issue, the Companies still will be confronted with the issue of excessive generation during daytime periods. The excessive DG (primarily PV) generation causes issues with the dispatch of the Companies' thermal generation units and possible curtailment of other renewable resources. It is necessary to keep these units operating to be able to immediately address voltage issues in the event of a disruption in the aggregate DG generating capacity. Such a disruption could occur during significant, yet intermittent, cloud cover or, in a more extreme case, potential large-scale damage to the DG systems due to a hurricane. Time-variant rates could be designed to encourage all customers to shift their consumption to daylight periods. By increasing their daytime load, the Companies may be able to address the issues related to the dispatch of thermal resources. In addition, such an increase in load may reduce the requirement to curtail output from the lower cost utility-scale renewable generation facilities.
- *One-time interconnection charge*. This charge would include the cost of performing required interconnection studies that may be required depending on the proposed system size. In addition, the interconnection charge would include the cost of required or potentially required customer transformer upgrades, because of the level of DG

## 6. Cost Allocation and Rate Impacts

### 6.4 DG 2.0

connected to those transformers, as well as reconductoring costs, substation transformer costs, and other costs required to accommodate increased levels of DG. With the exception of the interconnection request studies, the DGIP upgrade costs are extensively described in Section 2 of the DGIP

- *Grid services charge* – This charge would be levied on all DG customers to recover the significant generation reserves that the Companies must maintain to ensure reliability in the event of widespread DG outages, due to either significant cloud cover or potential large-scale damage to DG systems. The Companies acknowledge that the cost causation effected by DG customers will vary according to system size, location, and whether the customer also has installed energy storage as part of the DG system, and that the Grid Services charge must be calculated accordingly and perhaps differently for different types of DG customers.
- Consideration of curtailment policies and compensation schedules that will equitably credit customers in the event that system curtailment is necessary.
- Consideration of fair and appropriate “grandfathering” policies regarding existing and potential DG customers who are currently participating or have applied for inclusion in the NEM program. The Companies note that as a part of this process, future DG customers may need to acknowledge that the rules relating to the interconnection of their DG systems, including rules relating to required system controls, electricity rates, charges, and fees, are subject to future modification and that such modifications may positively or negatively affect potential savings or the expected value of their DG system.
- As a party to Order No. 32269 issued by the Commission on August 21, 2014, the Companies will consider the above challenges – and other potential rate reform options – as part of an overall approach to distributed generation called "DG 2.0."<sup>57</sup>

---

### 6.4 DG 2.0

As identified above, the Companies recommend a progression away from the current NEM program and other programs toward a system that provides more customer choice, lower energy costs, and increased access to sustainable renewable resources. The Companies view this progression as part of a spectrum of the relationships between the utilities and customers. The spectrum includes the current situation of significant participation in the Companies’ NEM program and its associated explosive growth and the attendant technical and economic challenges described throughout the DGIP.

---

<sup>57</sup> The potential bill impacts of a hypothetical "DG 2.0" model are discussed in the PSIPS.

The Companies further believe that those challenges now make it necessary to revise the current course of the Companies to enable a move along the spectrum toward a truly different utility business model, one that includes partnering with customers. Companies view this as a shift toward DG 2.0, which will consist of a set of reformed tariff structures and a more equitable approach to managing DG growth more generally. **Table 6-3** summarizes the Companies' view of this spectrum and the relative issues associated with various components of the spectrum.

This Page Intentionally Left Blank

	Key Challenges for Hawai'i	NEM	Schedule Q	Solutions Needed	DG 2.0
<i>Operational</i>	<ul style="list-style-type: none"> <li>Excess DG generation</li> <li>Ramp up and down</li> <li>Generation flexibility, including sub-hourly</li> <li>Peaking capability</li> <li>Circuit constraints</li> <li>Frequency and voltage</li> </ul>	<ul style="list-style-type: none"> <li>Distorted incentives lead to excess DG generation</li> <li>DG is highly variable and intermittent</li> <li>Commitment to clean energy</li> <li>Environmental benefits</li> <li>Prevents efficient system upgrades</li> </ul>	<ul style="list-style-type: none"> <li>Tariff-based service, flexible</li> <li>More equitable rates can lead to sustainable growth rates</li> <li>Signal need for system controls and system upgrades</li> <li>Commitment to clean energy</li> </ul>	<ul style="list-style-type: none"> <li>Operational control</li> <li>Storage</li> <li>Two-way communication</li> <li>Advanced technology</li> <li>Demand response/EE</li> <li>Fast start generation</li> <li>Curtailment</li> <li>Cybersecurity</li> <li>Proactive planning</li> </ul>	<ul style="list-style-type: none"> <li>Reliability and resiliency upheld</li> <li>Innovation with others to improve solutions and costs</li> <li>Flatten load shape</li> <li>Systematic monitoring solutions</li> <li>Incentive to right-size systems</li> <li>Incentive to install storage, and proactively mitigate circuit overload issues</li> </ul>
<i>Policy</i>	<ul style="list-style-type: none"> <li>Cost shifting is occurring</li> <li>Current rules may not work in highly penetrated areas</li> <li>Queues are constrained with multiple programs</li> </ul>	<ul style="list-style-type: none"> <li>Provides customer choice and control, but limits them to system configurations that maximize NEM economic benefits</li> </ul>	<ul style="list-style-type: none"> <li>Introduce a modified version as a transition step to DG 2.0</li> </ul>	<ul style="list-style-type: none"> <li>Transition to a modified Schedule Q for new systems</li> <li>Launch working group for long-term solution</li> <li>Ensure power quality, reliability, resiliency</li> <li>Consumer protection through DG life cycle</li> </ul>	<ul style="list-style-type: none"> <li>Cost causation</li> <li>Align costs with benefits</li> <li>Provide DG options to more customers</li> <li>Protect interests of all customers</li> <li>Separate generation from consumption</li> </ul>



## 6. Cost Allocation and Rate Impacts

### 6.4 DG 2.0

	Key Challenges for Hawai'i	NEM	Schedule Q	Solutions Needed	DG 2.0
<i>Economic</i>	<ul style="list-style-type: none"> <li>Allocate costs fairly</li> <li>Pricing signals to optimize cost, reliability, and resiliency</li> <li>Align costs and benefits of DG</li> <li>Lowers bills for all customers</li> <li>Equitable rate structure across customers</li> </ul>	<ul style="list-style-type: none"> <li>Rates difficult to reconcile with other procurement (i.e., highest priced resource—full retail rates)</li> <li>Cost shifting</li> <li>Rates are easy to understand</li> <li>Fixed cost recovery not aligned with benefits</li> <li>Can lower overall fuel procurement costs</li> </ul>	<ul style="list-style-type: none"> <li>Rates based on competitive costs</li> <li>Rates easy to understand</li> <li>Does not address revenue erosion issues, only payment rates</li> <li>Lowers DG power procurement costs</li> <li>Can lower overall fuel procurement costs</li> </ul>	<ul style="list-style-type: none"> <li>Transparent queue with pricing signals</li> <li>Pricing to keep utility-scale renewables from competing with DG renewables</li> <li>Equitable rate structure</li> </ul>	<ul style="list-style-type: none"> <li>Market-based pricing signals</li> <li>Compensation for non-energy services</li> <li>Allows for more readily comparable procurement costs</li> </ul>

Table 6-3. Overview of Existing and Future DG Tariffs

DG 2.0 will include substantial collaboration between the Companies and the community.

The Companies anticipate that future utility-scale renewable resources will be developed in the Hawaiian Islands given their economies of scale and resultant lower costs and higher value than individual DG can provide. The Companies recognize that the circumstances around each of these individual projects will differ and, in some cases, will provide the communities with the most value if the Companies develop and own them; in other cases, they will provide the communities with more value if they are developed and owned by third parties.

Customer-owned resources are expected to include current and future DG solar resources. The Companies expect future adoption of DG solar resources to increase as the Companies implement the measures identified in the DGIP that are designed to enable the current systems to incorporate additional amounts of DG. Among these measures are those described above, which include export and non-export systems owned by individual customers. Further, the Companies expect that in the DG 2.0 concept, DG customers will be strongly encouraged to participate in the Companies' Demand Response pricing programs, which will allow the Companies additional control over DG customers' generation exports, with the consent of those customers.

The Companies expect the potential for jointly owned or developed resources to be a significant component of the future. DG 2.0 contemplates a future in which community solar projects offer many current customers the opportunity to participate in low-cost renewable energy projects. Because over 40% of Hawaiian households are rented,<sup>58</sup> a significant portion of the Companies' customers are unable to install or own DG resources because of lack of access to the rooftop space required. Community solar projects potentially can address this inequity by pooling investments from members of a community to finance utility-scale solar projects to provide solar power and/or financial benefits in return. They can be developed and owned by the utility or through a PPA contract with third parties. In practice, the projects are funded by preselling portions of the projects to community members, who then receive credits on their energy bills for their portion of the energy produced by the projects. Benefits to the communities include the ability to participate in renewable energy projects, even though they do not own rooftop space; easier implementation relative to the challenges posed in self-installing DG systems; and the potential for reduced energy bills and protection against future increases in fuel prices. Benefits to the grid include reduced transmission and distribution system impacts, the ability to strategically site the projects, and improved dispatch control over DG.

---

<sup>58</sup> 2012 ACS Census data.

## 6. Cost Allocation and Rate Impacts

### 6.4 DG 2.0

Another potential form of collaboration between the Companies and customers in the future may consist of the Companies' becoming the owner and installer of rooftop PV systems on individual customer's facilities. In this program, the Companies would install PV systems on individual customer's roofs, with the Companies' retaining ownership and operation of the systems. In this scenario, the customers would benefit by receiving credits on their energy bills in exchange for the Companies' use of their roof. The Companies acknowledge that such a program would require a significant amount of design, regulatory review, and implementation issues before becoming a component in the future, and, in fact, the Companies identify them herein only as one of many potential future activities of the Companies.

The Companies envision a strong, collaborative utility of the future; one in which the traditional lines of utility-owned generation and customer-purchased energy have become blurred or perhaps eliminated. The Companies' vision for such a future includes the DG 2.0 concept which is described herein. The Companies expect that the progression away from the existing system and programs will require further clarification, definition and explanation, and commit to working with the utilities' customers, partners, and stakeholders as part of this comprehensive effort.

## 7. Consumer Protection and Interconnection

The Companies are required to provide safe and reliable delivery of electricity. Key to this is the protection of existing utility infrastructure and customer assets. The customer protection and interconnection processes were created to manage and mitigate new DG installations across all programs. A customer's failure to comply with these rules and procedures, as documented on Hawaiian Electric's website, can result in compromises to the reliability and safety of the electric grid, causing unreasonable costs to customers in the form of damage to customer- and utility-owned electrical equipment and appliances.

Before a customer's contractor can begin installation of a DG asset, the contractor must complete all the steps required by the utility, which include the following:

- Submit an interconnection application agreement, including:
- Complete additional paperwork (e.g., single line diagrams, settings documentation) required by the proposed size of a DG asset
- Allow safety and reliability studies before DG interconnection, which includes an interconnection review and, if needed, a full IRS
- Obtain all appropriate permits from the city and county authorities
- Complete all required and appropriate inspections and obtain approval from appropriate city and county authorities
- Install a labeled and lockable utility disconnect switch in proximity of the meter or location approved by the utility
- Customer must understand all requirements and assess all costs before agreeing to work with a contractor

## 7. Consumer Protection and Interconnection

- Customer's contractor must adhere to all interconnection requirements, as documented in Rule 14H and provided on the Companies' websites, including the following:
- Determine if an IRS is required
- Perform an IRS to ensure the utility that all customers will receive reliable service and good power quality, including mitigation of flicker, outages, and voltage instability, which includes:
- Ensure the DG system does not backfeed power into a de-energized electric line
- Avoid potential disruptive voltage swings that could damage customer or utility equipment.

The processes described above are governed by Rule 14H for generation interconnection and give the Companies the authority to set requirements and limits for the safety, performance, and reliability standards for DG interconnections.

The Companies are instituting a program to report on locations that are generating power, but have not completed the interconnect process. If noncompliance is suspected, a site visit by utility personnel may be warranted. If the Companies identify these consumers, the consumers will receive notice of their noncompliance and must remediate the situation by immediately complying with the process or by disconnecting their systems. The Companies will subsequently check the consumer to ensure the consumer is adhering to the requests.

The Companies are working with the utilities industry to gain broader knowledge of the in-place tools, processes, and programs. As Hawai'i moves toward DG 2.0 and new programs and solutions evolve and come into the market, customers and industry stakeholders could benefit from access to a solar standards group to help consumers and industry with operational and contractual matters as DG programs and financial conditions change. Previous work with the Consumer Advocate, the Department of Commerce and Consumer Affairs, and the Better Business Bureau included initiatives to protect DG customers and contractors that follow the applicable rules. To ensure reliable and safe interconnections of DG, the Companies will continue to work with the PV industry, the Consumer Advocate, and the Department of Commerce and Consumer Affairs to secure better overall compliance and to identify reasonable solutions to noncompliance situations. The Companies also will work with the Commission, Consumer Advocate, and appropriate executive, legislative, or regulatory agencies and bodies to help ensure that these rules are applied fairly to all consumers and all consumers are able to adhere to these rules.

# 8. Roadmaps and Plan Summaries

As the Commission observed in Order No. 32053, it is unrealistic to expect that the high growth in distributed solar PV capacity additions experienced in the 2010–2013 time period can be sustained in the same technical, economic, and policy manner in which they occurred. Consequently, a solution is presented that will include installing advanced metering and control systems that use data to drive decisions and investment, incorporating improved circuits that can accommodate far more DG, using advanced inverters that have two-way interactions with the grid, supporting non-export DG solutions that may incorporate battery systems, and having a balanced model of rates and programs that balance customers’ needs equitably, while sending appropriate price signals that allow customer choice. **Figure 8-1** summarizes the solution for a DGIP.

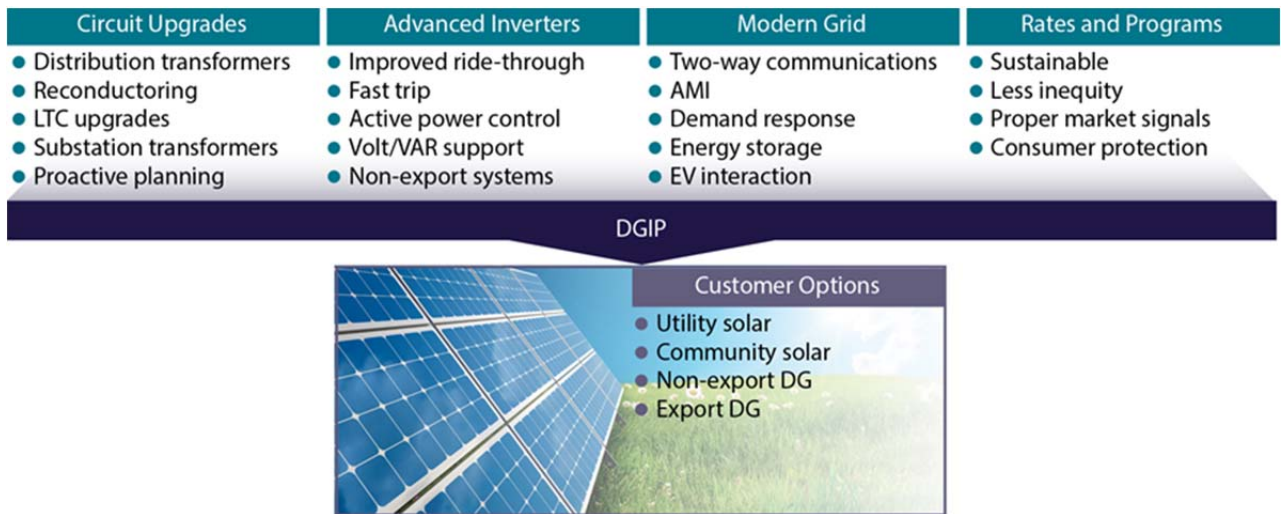

Figure 8-1. The Comprehensive Distributed Generation Interconnection Plan

## 8.1 PLANNING APPROACH

The Companies have predicted the growth of DG and have used these growth projections to analyze the system- and circuit-level implications. The DGIP addresses the circuit-level implications, including the impacts at the customer premises. **Figure 8-2** provides the DG growth projection that was used in preparing the plan.

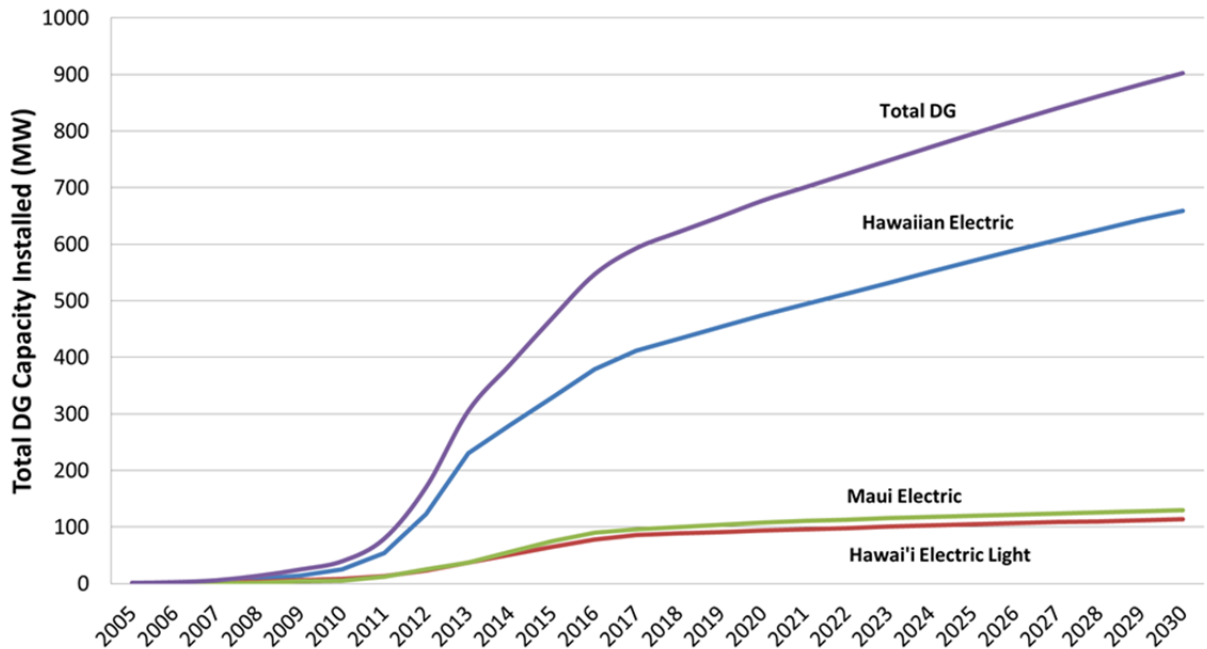

Figure 8-2. DG Growth Projections

Based on this DG profile, the Companies developed potential mitigations. The mitigations take three primary forms, as directed by the Commission: circuit remediation, advanced technology utilization, and rate reform. The curves in **Figure 8-2** presume rate reform. The expected time frames for the proposed mitigation measures are as follows:

- Short-Term (2014–2016)
- Medium-Term (2017–2020)
- Long-Term (2021–2030)

## 8.2 SHORT-TERM PLANS

### 8.2.1 Inverters

Increasing DG penetration depends on the deployment of improved inverters. Current constraints on DG deployments are driven by three inverter-related issues: transient over-voltage (TrOV), frequency ride-through, and the inability to curtail the inverters. The following activities are recommended to immediately address these concerns:

- **Transient Over-Voltage:** Inverters must have fast-trip or other features to address TrOV. Lacking these abilities, a limit of 120% gross daytime minimum load (GDML) may be required, which will not allow the projected DG growth. To support these capabilities, the Companies plan to work with industry on requirements and testing, including the creation of an inverter test facility.
- **Frequency Ride-Through:** Improved frequency ride-through settings will remediate system-level constraints associated with generation loss. IEEE 1547a-2014 supports this function, and the Companies have filed a stipulation requiring the new settings. The plan also includes working with industry to evaluate mechanisms for retroactively applying these new parameters.
- **Inverter Control:** To manage excess energy, inverters will be required to have active power control for their generation, either proportionally or as an on/off signal. While the ability for the utility to command these is years away, third parties in the industry may be able to issue these commands in coordination with the utility. The plan is to work with industry to develop curtailment capabilities and to require these capabilities in all new inverter installations as soon as they are available.

### 8.2.2 Circuit Improvements

To address circuit and substation steady-state impacts, the circuit and substation capacity analysis compares existing and projected loads and DG penetration and identifies constraints to reverse power flow on circuits and substation transformers. The remediation includes the following:

- **Load Tap Changer (LTC) Controller Replacement Program:** Transformers are flagged when existing or approaching reverse power flow is anticipated, and required LTC controller upgrades are identified and scheduled.
- **Circuit Upgrade Program:** Circuits with reverse power flow are flagged when the 50% thermal limit of the circuit backbone capacity was approached or if previous studies had identified conductor or voltage constraints. Circuit upgrade projects are identified and scheduled.



## 8. Roadmaps and Plan Summaries

### 8.2 Short-Term Plans

- **Substation Transformer Program:** Transformers with reverse flow were flagged when the 50% thermal limit of the rated capacity was approached.
- **Grounding Transformer Program:** Preselected circuits for Maui Electric and Hawai'i Electric Light with DG exceeding 33% GDML were flagged for grounding transformers; Hawaiian Electric 46 kV lines with DG exceeding 50% GDML were flagged for 46 kV grounding transformers.

In addition, secondary over-voltage and thermal issues are addressed with advanced inverter requirements and upgrades to the customer distribution transformer and secondary conductors. Because these issues are specific to the location of new DG, they cannot be addressed through a standard process or a proactive program, but must be evaluated individually through the interconnection screening review; however, for completeness, the systemwide estimated costs include these upgrades.

Distribution transformers with an estimated reverse flow of more than 100% of the transformer rating were flagged for transformer upgrades, and 15% are assumed also to require secondary upgrades.

The Companies have taken steps to be more proactive in addressing the current infrastructure constraints. With more aggressive infrastructure modernization and with monitoring and data analytics using new DG management tools, additional DG can be added to the various island grids. To arrive at the funding timeline, the Companies made assumptions about projected minimum loads and the growth rate of DG; accelerating the growth in DG would accelerate the spending. **Table 8-1** and **Table 8-2** summarize the amount of DG that is projected per island and show the costs that may be necessary per island to enable this DG growth.

Item	Violation Trigger	Unit Cost	2016	2020	2030	Total
Installed DG (MW)	--	--	547	677	902	902
Regulator	Feeder Reverse Flow	\$10,000	\$187,000	\$55,000	\$66,000	\$308,000
LTC	Substation Transformer Reverse Flow	\$10,000	\$912,000	\$264,000	\$466,000	\$1,642,000
Reconductoring	Exceed 50% Backbone Conductor/Cable Capacity	\$1,100,000 OH/ \$4,300,000 UG per mile	\$-	\$-	\$75,588,700	\$75,588,700
Substation	Exceed 50% Capacity	\$2,250,000	\$2,541,000	\$2,475,000	\$49,750,000	\$54,766,000
Distribution Transformer	Exceed 100% Loading, % GDML Linear Relationship to % Transformers Upgraded	Varies	\$4,462,164	\$4,386,633	\$6,768,738	\$15,617,535
Poles and Secondary	15% of Distribution Transformer Replacements Include Pole Replacement and Secondary Upgrades	Varies	\$1,016,605	\$993,371	\$1,523,365	\$3,533,342
Grounding Transformers	Exceed 33% GDML (66% in model) for Selected Feeder for Maui Electric and Hawai'i Electric Light; exceed 50% GDML for 46 kV Lines for Hawaiian Electric	\$60,000 for Maui Electric and Hawai'i Electric Light; \$947,000 for Hawaiian Electric	\$33,033,000	\$6,095,100	\$3,917,100	\$43,045,200
<b>Total</b>	--	--	<b>\$42,151,769</b>	<b>\$14,269,104</b>	<b>\$138,079,904</b>	<b>\$194,500,777</b>

Table 8-1. Violation Trigger and Base Case Cost Model Summarization, by Term

Company	2016 Total Upgrade Cost	2020 Total Upgrade Cost	2030 Total Upgrade Cost	Total Upgrade Cost
Hawaiian Electric	\$35,453,869	\$10,377,345	\$136,588,862	\$182,420,075
Maui Electric	\$2,607,773	\$2,539,424	\$1,227,066	\$6,374,262
Maui	\$2,549,973	\$2,260,697	\$1,218,660	\$6,029,330
Molokai	\$57,800	\$278,727	\$8,406	\$344,933
Lanai	\$-	\$-	\$-	\$-
Hawai'i Electric Light	\$4,090,127	\$1,352,336	\$263,976	\$5,706,439
<b>Total</b>	<b>\$42,151,769</b>	<b>\$14,269,104</b>	<b>\$138,079,904</b>	<b>\$194,500,777</b>

\* in current year dollars

Table 8-2. Total Upgrade Costs by Company by Time Period

### 8.2.3 Technology Demonstration Program

The Companies will oversee ADERTUP-related development and the maturation of the associated technologies. A central organization will be the primary point of contact among the Companies, the industry, and interested parties. The Companies will develop laboratories for testing inverters, non-export systems, and EV technologies.

Demonstration programs for distributed energy storage and future EV efforts will be conducted. It also will coordinate interactions with the Distributed Energy Resources (DER)-Technology Working Group (DER-TWG), as directed in the Order.

To fund the purchasing of infrastructure and test equipment associated with this function, the Companies propose the funding profile in **Table 8-3** for first three years of funding. As the projects proceed, the Companies will review the project costs and make subsequent requests in future years if needed.

Project	Annual Costs (\$000)				Cost Breakdown (\$000)			
	2015	2016	2017	Total	Capital	O/S	Labor	Total
Inverter Testing Program	290	290	290	870	0	750	120	870
Substation Storage Demo Project (2016)	60	2,120	20	2,200	1,900	150	150	2,200
Outside Services—DER Assessment, RD&D, Controls	140	165	202	507	0	507	0	507
<b>Totals</b>	<b>490</b>	<b>2,575</b>	<b>512</b>	<b>3,577</b>	<b>1,900</b>	<b>1,407</b>	<b>270</b>	<b>3,577</b>

\* in current year dollars

Table 8-3. Advanced Technology Project Cost Breakdown

Many industry technology development activities with smart inverters, energy storage, and even modern grid technologies will directly influence DG management activities with the Hawaiian utilities. As mentioned, many of the operating characteristics of utilities on islands are unique and differ from mainland utilities' activities; therefore, the Companies will continue to be involved in the standards and technology development activities within different industry committees, such as the IEEE 1547 Working Group and the Smart Inverter Working Group (SIWG).

## 8.3 ADVANCED DER UTILIZATION PLAN

The plan looks at two-way communications, advanced inverters, energy storage, demand response, and electric vehicles (EVs) and lays out a timeline for solutions coming online that will help integrate DG into the grid. The mid- and long-term key to increasing DG is

increased control of power by the utility, which is achievable through smart grid and advanced metering infrastructure (AMI). As the smart grid is implemented, the overall system will become much more dynamic.

The two-way communications, including the new AMI program, will enable more visibility and control capability for interaction with distribution sited energy storage, demand response through direct load control, and two-way interaction with EVs. Changes in DG technology can be accommodated as the utility enables more plug-and-play capabilities (new infrastructure and programs), which can help support increased system utilization of DG resources.

The roadmap for implementing these technologies is illustrated in **Figure 8-4**. The goals for increased DG penetration are based on these timelines. The implementation of these technologies may provide mitigation that postpones or alleviates some of the identified circuit improvements. As better data and technology become available, a cost-benefit analysis should be performed before investing in equipment upgrades to evaluate other options.

**8. Roadmaps and Plan Summaries**  
**8.3 Advanced DER Utilization Plan**

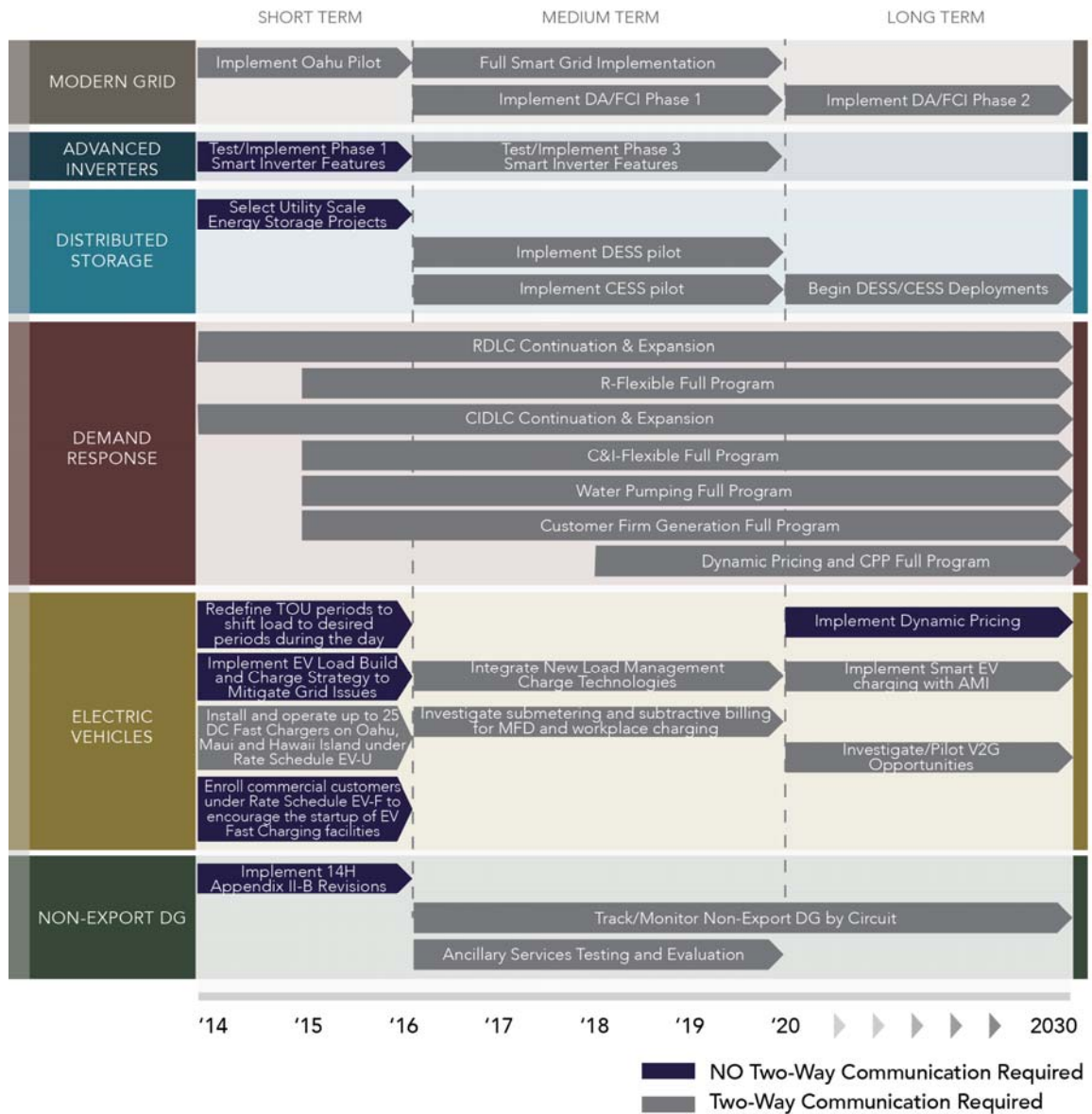

Figure 8-3. Advanced Distributed Energy Technology Roadmap

Note that the Companies recently made filings to the Commission regarding demand response<sup>59</sup> and electric vehicles<sup>60</sup>. These filings lay out the Companies’ near-term plans.

<sup>59</sup> Hawaiian Electric Company, Inc., Integrated Demand Response Portfolio Plan, filed with the Hawai‘i Public Utilities Commission July 28, 2014.

<sup>60</sup> Hawaiian Electric Company, Inc., Electric Vehicle Pilot Rates Final Evaluation Report, July 2014.

---

## 8.4 NON-EXPORT SYSTEMS

As discussed in Section 5, non-export DG is generation for customer use only; that is, no excess energy is transmitted to the power grid. Non-export DG is effectively a load offset, similar to exporting DG, but without the excess generation (i.e., reverse power flow). The use of non-export DG may allow for greater adoption of DG. To facilitate the creation of these options for customers, the plan is to:

- Finalize the docket for interconnection review of non-export DG systems and consider processes for parallel non-export DG with energy storage considering the potential for grid services and home-based energy management systems
- Facilitate the discussion of portions of the Rule 14H energy storage proceedings within the DER-TWG meetings to raise the non-export parallel operation DG treatment issue
- Develop rate structure in a future docket to consider customer usage and standby charges
- Investigate transient behavior of multimode inverters for parallel non-export DG with energy storage
- Engage the industry to establish certifications, standards, and any testing requirements for non-export including:
  - Validation & monitoring for certain period of adjustments
  - Needed devices and equipment for non-export configuration
  - Needed controllers and or devices for utility-controlled export services to support grid
  - Needed controllers for aggregated control systems autonomously and/or by utility
- Rule 14H updates to accommodate utility control for grid support

---

## 8.5 RATES AND PROGRAMS

The Companies recommend that the current net energy metering (NEM) program be transitioned to a solution that is closer to a “Gross Export Purchase” model, which has different rates for export and for consumption. The Companies further recommend adopting a modified Schedule Q and non-export transitional stage as part of the overall strategy.

## 8. Roadmaps and Plan Summaries

### 8.5 Rates and Programs

Specifically, the Companies recommend that this new program include *some or all* of the specific provisions highlighted below. These recommendations are described in more detail in Section 6 of this plan.

- A revised rate, based on a new methodology and assumptions, at which customers will be credited for gross exported energy
- Rate design that possibly includes implementing a time-variant element, a one-time interconnection charge and/or a grid services charge to complement the Gross Export Purchase program
- Curtailment policies and crediting schedules to equitably compensate customers during a curtailment event
- Fair and appropriate “grandfathering” policies for DG customers currently in the NEM program
- As a party to Order No. 32269 issued by the Commission on August 21, 2014, the Companies will consider the above challenges – and other potential rate reform options – as part of an overall approach to distributed generation called “DG 2.0”.

The most significant means for reducing circuit improvement costs is to limit the DG capacity on a given circuit, which can be accomplished in a variety of ways. These methods include placing hard limits on the DG to be installed, limiting the size of DG systems and requiring the use of non-export systems on circuits with high DG penetration. The cost-benefit approach balances investment costs against the benefit and expense of installing significantly larger amounts of DG. Therefore, it would improve circuits where those investments would lead to a large increase in DG penetration, but it would limit the amount of investment to be made where such improvements would lead to only incremental increases in DG. Selection of the most appropriate method, or combination of methods, to reduce overall circuit improvement costs should be accomplished through a transparent process involving all affected stakeholders.

# A. DGIP Compliance Matrix

ID	Section/Requirement/Observation	Comment
II.B.4.	Distributed Generation Interconnection Plan	N/A
.	For the reasons identified by the PV-DG Subgroup and the observations and perspectives set forth above, the commission believes a proactive approach to distributed generation planning specifically, and utility planning in general, when done in a transparent manner and with opportunity for stakeholder participation, is the preferred course of action. The commission concludes that further information and analysis is necessary in order to analyze potential constraints that exist due to high penetration of solar PV systems, and as a result, develop strategies and plans to mitigate these constraints. The commission is, therefore, ordering the HECO Companies to file a Distributed Generation Interconnection Plan {"DGIP"} with the commission within 120 days of the date of this Decision and Order, which shall include, at a minimum, the following components:""^\	ES, Sections 3-4
II.B.4.a.	A Distributed Generation Interconnection Capacity Analysis which shall proactively identify distribution circuit capacity to safely and reliably interconnect distributed generation resources and the system upgrades requirements necessary to increase circuit interconnection capability in major capacity increments.	3.1.4
.	The Distributed Generation Interconnection Capacity Analysis shall, at a minimum, also consider:	N/A
a.i.	Analyses of technical impacts and challenges associated with export of energy from distributed generation at levels that result in sustained backfeed of power from distribution circuits into the distribution substation during day-time hours;	Section 2.1
a.ii.	Development of recommended circuit upgrade requirements, including	Section 2.2



## A. DGIP Compliance Matrix

ID	Section/Requirement/Observation	Comment
	associated costs and ratepayer impacts, to enable circuit penetration limits to be raised in a logical, step-wise manner;	
a.iii.	Identification of circuit penetration limits (expressed as a percent of gross GDML) that would represent a sound, technical-based progression to increase circuit penetrations in a step-wise manner as experience is gained, and technical feedback is acquired with higher penetration levels, including timelines to propose when those increasing limits would be implemented; and	Multiple places covered throughout document
a.iv.	Impact of system level limitations on aggregate amount of variable renewable energy and how it relates to potential limits on interconnection of distributed generation incorporating analysis and conclusions from the Power Supply Improvement Plans.	Section 2
II.B.4.b.	An Advanced DER Technology Utilization Plan which shall set forth the near, medium and long-term plans by which customers would install, and utilities would utilize, advanced inverters, distributed energy storage, demand response and EVs to mitigate adverse grid impacts starting at the distribution level and up to the system level. This Plan and associated implementation process shall also be submitted to the commission for approval in a subsequent proceeding, as appropriate.	Section 4
.	The Advanced DER Technology Utilization Plan shall, at a minimum, also include:	N/A
b.i.	Plans to utilize grid support functionality embedded in advanced inverters, including autonomous controls and two-way communication to provide, among other capabilities, real-time PV output visibility to the system operator and also the ability to limit export of excess solar PV energy;	Section 4.2
b.ii.	Proposed requirements for new DER inverters to utilize state-of-the-art technical capabilities such that these system can provide autonomous grid support functions, enable active utility control of DER and provide ancillary services as grid conditions require;	Section 4.2.4
b.iii.	Stakeholder input in-the tariff development process by which standards for advanced inverters are adopted for inclusion in Rule 14H, prior to filing with the commission;	Section 4.2.4, Section 5
b.iv.	Plans to enable two-way communications with all customer installed DER equipment using proposed AMI communications infrastructure or other suitable communications networks;	Section 4.1.4
b.v.	Plans to utilize distributed energy storage, sited either on utility distribution infrastructure or on the customer side of meter, to mitigate impacts of high penetration solar PV systems; and	Section 4.3

ID	Section/Requirement/Observation	Comment
b.vi.	Plans to utilize the technical capabilities of advanced inverters, energy management control systems and customer energy storage systems to develop non-export options for distributed generators as well as options to provide ancillary and other grid support services, and appropriate tariff provisions to accommodate this.	Section 4.6
II.B.4.c.	A Distribution Circuit Improvement Implementation Plan which shall summarize the specific strategies and action plans, including associated costs and schedule, to implement circuit upgrades and other mitigation measures to increase capacity of electrical grids to interconnect additional distributed generation. The Distribution Circuit Improvement Implementation Plan shall, at a minimum, also consider:	Section 3
c.i.	Prioritization of proposed mitigation actions to focus on the immediate binding constraints for interconnection of additional distributed generation, whether on high penetration distribution circuits or at the system level, depending upon the situation on each island grid;	Section 3 short term, mid-term, long-term mitigations and costs and <b>Table 3-7</b> for potential mitigation measures and timing
c.ii.	Analysis of the cost and benefits of proposed mitigation strategies and action plans;	Under construction in section 3
c.iii.	Discussion of how distribution system design criteria, and operational practices, could be modified to enable greater interconnection of distributed generation systems; and	Section 3.1.5.
c.iv.	Proposals for addressing the cost allocation issues associated with who bears responsibility for system upgrade costs.	Small piece in 3.2, but full section 5 on this.

**A. DGIP Compliance Matrix**

This Page Intentionally Left Blank



## B. DG Market Forecast Methodology

---

### OVERVIEW

The distribution circuit upgrade requirements developed in the DGIP were based on market-driven forecasts for DG penetration across Oahu, Maui, and Hawai'i. At a high level, these forecasts represent the Companies' view of what DG uptake could be as existing DG programs (including NEM) are transitioned to DG 2.0 in the medium term.

This Appendix provides an overview of the methodology used to arrive at these forecasts.

---

### KEY ASSUMPTIONS

#### Customer classes

For each island, separate projections were developed for residential and commercial customers and aggregated into an overall forecast for DG PV installed capacity. Eligible market size was based on technical penetration limits, absolute sizes of customer classes, and future growth assumptions.

#### Short-term (2014–2016) installed capacity assumptions

From 2014 to 2016, a set rate of interconnection under existing DG programs was assumed, based on simplifying assumptions about queue release and the pace of new applications. Separate projections for existing NEM, FIT, and SIA programs were developed and aggregated under these short-term assumptions. Note that these

## B. DG PV Market Forecast Methodology

### Key assumptions

simplifying assumptions do not account for constraints on DG installations based on system-reliability or transient-over-voltage concerns.

### Market-driven (2017–2030) installed capacity assumptions

From 2017 onward, the DG 2.0 tariff structure was assumed to apply across all customer classes. Market-driven forecasts were developed using installed capacities as of year-end 2016 as a starting point.

### Rate structure

#### DG 2.0

The Companies' strategic vision for DG encompasses reform of the rates governing interconnections under DG 2.0. As part of DG 2.0, the current NEM program would be transitioned to a tariff structure for dispatchable DG systems that more fairly allocates fixed grid costs to DG customers and credits customers for the value of their excess energy.

As a party to Order No. 32269 issued by the Commission on August 21, 2014, the Companies view this as an opportunity to evaluate the precise nature and timing of the DG 2.0 rate reform. A preliminary set of assumptions regarding DG 2.0 has been made to facilitate the financial and capacity modeling performed in the PSIPs and DGIP, but these assumptions should not be interpreted as a policy recommendation. These rate assumptions are consistent with the Companies' desire to set fair tariffs that enable customer choice. As such, they adhere to the underlying principles of the Companies' DG strategy, and include the following:

- A fixed charge applied to all customers, allocating fixed customer service and demand costs in a fair, equitable, and revenue-neutral manner within customer classes
- A fixed monthly charge applied only to DG customers to account for additional standby generation and capacity requirements provided by the Companies
- A "Gross Export Purchase model" for export DG. Under this model, coincident self-generation from DG and usage is not metered and customers sell excess electricity near wholesale rates and buy additional electricity at variable retail rates

For the purposes of these projections, fixed monthly charges are assumed to comprise demand and customer service charge components.

The fixed demand charge has been estimated in two steps. First, a capacity requirement across all customers that would minimize cost shifts to low-usage customers was determined. Second, the fixed cost of meeting this capacity requirement for production, transmission, and distribution was calculated. An additional demand charge was also

applied to DG 2.0 customers, due to the higher peak capacity requirements that DG customers have, on average, compared to the broad class of residential customers.

In addition to fixed capacity-based charges, monthly customer charges were estimated by allocating the fixed costs associated with servicing individual customers across all relevant households. These costs were assumed to be uniform across customer classes.

These fixed charge projections, along with assumed feed-in-tariff rates under the envisioned Gross Export Purchase model, are shown in **Table B-1**.

	Monthly fixed charge - All HHs	Monthly fixed charge - DG only	Feed-in-tariff
Oahu	\$55	\$16	\$0.16
Hawai'i	\$61	\$16	\$0.18
Maui	\$50	\$12	\$0.20

Table B-1: Hypothetical DG Residential fixed charge and feed-in-tariff assumptions under DG 2.0

DG 2.0 is assumed to begin for all new DG customers in 2017.

### Retail rates

The price of energy purchased from the grid was assumed to be reduced from current rates (which include both fixed and variable components) in light of the fixed charge assumed for all households under DG 2.0 to ensure revenue-neutral rate reform.

## PV system assumptions

### Technical specifications

Average system sizes for residential customers were assumed to remain at 6kW on Oahu and Maui, and 4.5kW on Hawai'i, with PV production data aligned with PSIP modeling assumptions.

### System costs

PV system costs were forecasted to decline on a per watt basis in line with industry-accepted values and include federal and state tax credits as appropriate.

## Customer energy demand

Average customer load profiles and monthly energy consumption were assumed in line with the expected DG market.

---

## CALCULATIONS AND OUTPUT

Based on these assumptions, and using benchmarked relationships between the payback period of PV systems and customer uptake rates, the uptake rate for DG was projected for all residential and commercial customer classes from 2017 onward.

The calculated DG uptake rate was used to project the yearly installed capacity of DG across all customer classes, by island, under DG 2.0, starting in 2017. Short-term (2014-2016) and market-driven (2017-2030) forecasts were combined to yield 2014-2030 projections for DG installed capacity across all islands.

## Sensitivity analysis

These models necessarily made a number of simplifying assumptions. To address these simplifications, sensitivity analyses were performed around the most crucial assumptions, including projected retail rates, feed-in-tariffs, and fixed cost assumptions.

In general, the economics of DG in Hawai'i remain highly favorable to customers even under less favorable tariffs than those represented by DG 2.0; forecasts shift in line with changes to tariff structure, but are not overly sensitive to moderate changes.

If, however, customers continue to oversize systems, or if the eligible market for DG expands to include customers considered ineligible under the current forecast (e.g., residential customers in condominiums), the projections assumed here could increase substantially.

While these forecasts will undoubtedly shift as more detailed policies are developed, they nonetheless provided an essential starting point for the analysis conducted in the Companies response to the Order.

## C. Glossary and Acronyms

This Glossary and Acronym Appendix contains the terms used throughout the Power Supply Improvement Plan (PSIP), the Distributed Generation Interconnection Plan (DGIP) and the Integrated Interconnection Queue (IIQ) Plan. The Appendix clarifies the meaning of these terms, and helps you better understand the concepts described by these terms.

---

### A

#### **Adequacy of Supply**

The ability of the electric system to supply the aggregate electrical demand and energy requirements of the customers at all times, taking into account scheduled and reasonably expected unscheduled outages of system elements.

#### **Advanced DER Technology Utilization Plan (ADERTUP)**

A plan within the Distributed Generation Interconnection Plan (DGIP) that sets forth the near, medium, and long-term plans by which customers would install, and utilities would utilize, advanced technologies to mitigate grid impacts of distributed generation (DG) photovoltaics (PV).

#### **Advanced Distribution Management System (ADMS)**

A single system that includes an Outage Management System (OMS), Distribution Management System (DMS), and Distribution SCADA components and functionalities all in one platform, with a single user interface for the operator. ADMS will be used to help manage and integrate the new technologies and applications to be deployed as part of the utility's grid modernization program.



### **Advanced Inverter**

A smart inverter capable of being interconnected to the utility (via two-way communications) and controlled by it.

### **Advanced Metering Infrastructure (AMI)**

A primary component of a modern grid that provides two-way communications between the customer premises and the utility. An AMI is a necessary prerequisite to the interactions with advanced inverters, customer sited storage, demand response through direct load control, and EVs.

### **Alternating Current (AC)**

An electric current whose flow of electric charge periodically reverses direction. In Hawai'i, the mainland United States, and in many other developed countries, AC is the form in which electric power is delivered to businesses and residences. The usual waveform of an AC power circuit is a sine wave. In Hawai'i and the mainland United States, the usual power system frequency of 60 hertz (1 hertz (Hz) = 1 cycle per second).

### **Ancillary Services**

Services that supplement capacity as needed in order to meet demand or correct deviations in frequency. These include reserves, black start resources, and frequency response.

### **As-Available Renewable Energy**

See Variable Renewable Energy on page C-35.

### **Avoided Costs**

The costs that utility customers would avoid by having the utility purchase capacity and/or energy from another source (for example, energy storage or demand response) or from a third party, compared to having the utility generate the electricity itself. Avoided costs comprise two components:

- Avoided capacity costs, which includes avoided capital costs (for example, return on investment, depreciation, and income taxes) and avoided fixed operation and maintenance costs.
- Avoided energy costs, which includes avoided fuel costs and avoided variable operation and maintenance costs.

---

B

**Baseload**

The minimum electric or thermal load that is supplied continuously over a period of time. See also Load, Electric on page C-19.

**Baseload Capacity**

See Capacity, Generating on page C-4.

**Baseload Generation**

The production of energy at a constant rate, to support the system's baseload.

**Battery Energy Storage Systems (BESS)**

Any battery storage system used for contingency or regulating reserves, load shifting, ancillary services, or other utility or customer functions. See also Storage on page C-31.

**Black Start**

The ability of a generating unit or station to go from a shutdown condition to an operating condition and start delivering power without assistance from the electric system.

**British Thermal Unit (Btu)**

A unit of energy equal to about 1055 joules that describes the energy content of fuels. A Btu is the amount of heat required to raise the temperature of 1 pound of water by 1°F at a constant atmospheric pressure. When measuring electricity, the proper unit would be Btu per hour (or Btu/h) although this is generally abbreviated to just Btu. The term MBtu means a thousand Btu; the term MMBtu means a million Btu.

**Buy-All/Sell-All**

Tariff structure for DER under which customers would sell their entire DG output to the utility and purchase all of their requirements from the utility. This structure requires a two-meter system, with one meter to monitor grid import/export and one to monitor generation from the PV system.

## C

### Capacitor

A device that helps improve the efficiency of the flow of electricity through distribution lines by reducing energy losses. This is accomplished by the capacitor's ability to correct AC voltage so that the voltage is in phase with the AC current. Capacitors are typically installed in substations and on distribution system poles.

### Capacity Factor (cf)

The ratio of the average operating load of an electric power generating unit for a period of time to the capacity rating of the unit during that period of time.

### Capacity, Generating

The rated continuous load-carrying ability, expressed in megawatts (MW) or megavolt-amperes (MVA) of an electric generating plant. It is the maximum power that a machine or system can produce or carry under specified conditions, usually expressed in kilowatts or megawatts. Capacity is an attribute of an electric generating plant that does not depend on how much it is used. Types of capacity include:

***Baseload Capacity:*** Those generating facilities within a utility system that are operated to the greatest extent possible to maximize system mechanical and thermal efficiency and minimize system operating costs. Baseload capacity typically operates at high annual capacity factors, for example greater than 60%.

***Firm Capacity:*** Capacity that is intended to be available at all times during the period covered by a commitment, even under adverse conditions.

***Installed Capacity (ICAP):*** The total capacity of all generators able to serve load in a given power system. Also called ICAP, the total wattage of all generation resources to serve a given service or control area.

***Intermediate Capacity:*** Flexible generators able to efficiently vary their output across a wide band of loading conditions. Also known as Cycling Capacity. Typically annual capacity factors for intermediate duty generating units range from 20% to 60%.

***Net Capacity:*** The maximum capacity (or effective rating), modified for ambient limitations, that a generating unit, power plant, or electric system can sustain over a specified period, less the capacity used to supply the demand of station service or auxiliary needs.

**Peaking Capacity:** Generators typically called on for short periods of time during system peak load conditions. Annual capacity factors for peaking generation are typically less than 20%.

### Capital Expenditures

Funds expended by a utility to construct, acquire or upgrade physical assets (generating plants, energy storage devices, transmission plant, distribution plant, general plant, major software systems, or IT infrastructure). Capital expenditures for a given asset include funds expended for the acquisition and development of land related to the asset, obtaining permits and approvals related to the asset, environmental and engineering studies specifically related to construction of the asset, engineering design of the asset, procurement of materials for the asset, construction of the asset, and startup activities related to the asset. Capital expenditures may be associated with a new asset or an existing asset (that is, renovations, additions, upgrades, and replacement of major components).

### Carbon Dioxide (CO<sub>2</sub>)

A greenhouse gas produced when carbon-based fossil fuels are combusted.

### Combined Cycle (CC)

A combination of combustion turbine- and steam turbine-driven electrical generators, where the combustion turbine exhaust is passed through a heat recovery waste heat boiler which, in turn, produces steam which drives the steam turbine.

**2x1 Combined Cycle:** A configuration in which there are two combustion turbines, one heat recovery waste heat boiler, and one steam turbine. The combustion turbines produce heat for the single waste heat boiler, which in turn produces steam that is directed to the single steam turbine.

**Dual-Train Combined Cycle (DTCC):** A configuration in which there are two combustion turbines, two heat recovery waste heat boilers and one steam turbine. Each combustion turbine/waste heat boiler combination produces steam that is directed to the single steam turbine.

**Single-Train Combined Cycle (STCC):** A configuration in which there is one combustion turbine, one heat recovery waste heat boiler, and one steam turbine.

### Combined Heat and Power (CHP)

The simultaneous production of electric energy and useful thermal energy for industrial or commercial heating or cooling purposes. The Energy Information Administration (EIA) has adopted this term in place of cogeneration.

## C. DG PV Market Forecast Methodology

### Calculations and output

#### **Combustion Turbine (CT)**

Any of several types of high-speed generators using principles and designs of jet engines to produce low cost, high efficiency power. Combustion turbines typically use natural gas or liquid petroleum fuels to operate.

#### **Commercial and Industrial Direct Load Control (CIDLC)**

A demand response program that provides financial incentives to qualified businesses for participating in demand control events. Such a program is designed for large commercial and industrial customers.

#### **Commercial and Industrial Dynamic Pricing (CIDP)**

A demand response program that provides tariff-based dynamic pricing options for electrical power to commercial and industrial customers. CIDP encourages customers to reduce demand when the overall load is high.

#### **Conductor Sag**

The distance between the connection point of a conductor (transmission/distribution line) and the lowest point of the line.

#### **Connected Load**

See Load, Electric on page C-19.

#### **Contingency Reserve**

The reserve deployed to meet contingency disturbance requirements, the largest single resource contingency on each island.

#### **Curtailement**

Cutting back on variable resources during off-peak periods of low electricity use in order to keep generation and consumption of electricity in balance.

---

## D

#### **Daytime Minimum Load (DML)**

The absolute minimum demand for electricity between 9 AM and 5 PM on one or more circuits each day.

## Demand

The rate at which electricity is used at any one given time (or averaged over any designated interval of time). Demand differs from energy use, which reflects the total amount of electricity consumed over a period of time. Demand is often measured in Kilowatts (kW = 1 Kilowatt = 1000 watts), while energy use is usually measured in Kilowatt-hours (kWh = Kilowatts x hours of use = Kilowatt-hours). Load is considered synonymous with demand. (See also Load, Electric on page C-19.)

## Demand Charge

A customer charge intended to allocate fixed grid costs to customers based on each customer's consumption demand.

## Demand Response (DR)

Changes in electric usage by end-use customers from their normal consumption patterns in response to changes in the price of electricity over time, or to incentive payments designed to induce lower electricity use at times of high wholesale market prices or when system reliability is jeopardized. The underlying objective of demand response is to actively engage customers in modifying the demand for electricity, in lieu of a generating plant supplying the demand.

**Load Control:** Includes direct control by the utility or other authorized third party of customer end-uses such as air conditioners, lighting, and motors. Load control may entail partial or load reductions or complete load interruptions. Customers usually receive financial consideration for participation in load control programs.

**Price Response:** Refers to programs that provide pricing incentives to encourage customers to change their electricity usage profile. Price response programs include real-time pricing, dynamic pricing, coincident peak pricing, time-of-use rates, and demand bidding or buyback programs.

## Demand-Side Management (DSM)

The planning, implementation, and monitoring of utility activities designed to encourage consumers to modify patterns of electricity usage, including the timing and level of electricity demand. It refers only to energy and load-shape modifying activities that are undertaken in response to utility or third party-administered programs. It does not refer to energy and load-shape changes arising from the normal operation of the marketplace or from government-mandated energy efficiency standards. Demand-Side Management (DSM) covers the complete range of load-shape objectives, including strategic conservation and load management, as well as strategic load growth.

## C. DG PV Market Forecast Methodology

Calculations and output

### **Department of Business, Economic Development, & Tourism (DBEDT)**

Hawai'i's resource center for economic and statistical data, business development opportunities, energy and conservation information, and foreign trade advantages. DBEDT's mission is to achieve a Hawai'i economy that embraces innovation and is globally competitive, dynamic and productive, providing opportunities for all Hawai'i's citizens. Through our attached agencies, we also foster planned community development, create affordable workforce housing units in high-quality living environments, and promote innovation sector job growth.

### **Department of Land and Natural Resources (DLNR)**

A department within the Hawai'i state government responsible for managing state parks and other natural resources.

### **Direct Current (DC)**

A department within the Hawai'i state government responsible for managing Hawai'i's unique natural and cultural resources. Also oversees state-owned and state conservation lands.

### **Distributed Energy Resources Technical Working Group (DER-TWG)**

A working group to be formed as a review committee for DER-related technical assessments.

### **DG 2.0**

A generic term used to describe revised tariff structures governing export and non-export models, based on fair allocation of costs among distributed generation (DG) customers and traditional retail customers, and fair compensation of DG customers for energy provided to the grid.

### **Direct Current (DC)**

An electric current whose flow of electric charge remains constant. Certain renewable power generators (such as solar PV) deliver DC electricity, which must be converted to AC electricity, using an inverter, for use in the power system.

### **Direct Load Control (DLC)**

This Demand-Side Management category represents the consumer load that can be interrupted by direct control of the utility system operator. For example, the utility may install a device such as a radio-controlled device on a customer's air-conditioning equipment or water heater. During periods of system need, the utility will send a radio signal to the appliance with this device and control the appliance for a set period of time.

### **Direct Transfer Trip**

A protection mechanism that originates from station relays in response to a substation event.

### **Dispatchable Generation**

A generation source that is controlled by a system operator or dispatcher who can increase or decrease the amount of power from that source as the system requirements change.

### **Distributed Circuit Improvement Implementation Plan (DCIIP)**

A plan within the Distributed Generation Interconnection Plan (DGIP) that summarizes the specific strategies and action plans, including associated costs and schedules, to implement circuit upgrades and other mitigation measures to increase capacity of electrical grids to interconnect additional distributed generation.

### **Distributed Energy Resources (DER)**

Non-centralized generating and storage systems that are co-located with energy load.

### **Distributed Energy Storage**

Energy storage systems sited on the distribution circuit, including substation-sited and customer-sited storage.

### **Distributed Generation (DG)**

A term referring to a small generator, typically 10 megawatts or smaller, that is sited at or near load, and that is attached to the distribution grid. Distributed generation can serve as a primary or backup energy source and can use various technologies, including combustion turbines, reciprocating engines, fuel cells, wind generators, and photovoltaics. Also known as a Distributed Energy Resource (see page C-9).

### **Distributed Generation Interconnection Capacity Analysis (DGICA)**

A plan within DGIP to proactively identify distribution circuit capacity constraints to the safe and reliable interconnection of distributed generation resources. Includes system upgrade requirements necessary to increase circuit interconnection capability in major capacity increments.

### **Distribution Automation (DA)**

Programs to allow monitoring and control of all distribution level sources, as well as the automation of feeders to provide downstream monitoring and control.



### **Distribution Circuit Monitoring Program (DCMP)**

A document filed by the Companies on June 27, 2014, outlining three broad goals. First, to measure circuit parameters to determine the extent to which distributed solar photovoltaic (PV) generation is causing safety, reliability, or power quality issues. Second, to ensure that distributed generation circuit voltages are within tariff and applicable standards. Third, to increase the Companies' knowledge of what is occurring on high PV penetration circuits to determine boundaries and thresholds and further future renewable DG integration work.

### **Distribution Circuit**

The physical elements of the grid involved in carrying electricity from the transmission system to end users.

### **Distribution Transformer**

A transformer used to step down voltage from the distribution circuit to levels appropriate for customer use.

### **Disturbance Ride-Through**

The capability of DG systems to remain connected to the grid under non-standard voltage levels.

### **Droop**

The amount of speed (or frequency) change that is necessary to cause the main prime mover control mechanism to move from fully closed to fully open. In general, the percent movement of the main prime mover control mechanism can be calculated as the speed change (in percent) divided by the per unit droop.

### **Dual-Train Combined Cycle (DTCC)**

See Combined Cycle on page C-5.

---

## **E**

### **Economic Dispatch**

The start-up, shutdown, and allocation of load to individual generating units to effect the most economical production of electricity for customers.

### **Electric Power Research Institute (EPRI)**

A nonprofit research and development organization that conducts research, development and demonstration relating to the generation, delivery, and use of electricity.

### **Electric Vehicle (EV)**

A vehicle that uses one or more electric motors or traction motors for propulsion.

### **Electricity**

The set of physical phenomena associated with the presence and flow of electric charge.

### **Energy**

The ability to produce work, heat, light, or other forms of energy. It is measured in watt-hours. Energy can be computed as capacity or demand (measured in watts), multiplied by time (measured in hours). For example, a 1 megawatt (one million watts) power plant running at full output for 1 hour will produce 1 megawatt-hour (one million watt-hours or 1000 kilowatt-hours) of electrical energy.

### **Emissions**

An electric power plant that combusts fuels releases pollutants to the atmosphere (for example, emissions of sulfur dioxide) during normal operation. These pollutants may be classified as primary (emitted directly from the plant) or secondary (formed in the atmosphere from primary pollutants). The pollutants emitted will vary based on the type of fuel used.

### **Energy Efficiency DSM**

Programs designed to encourage the reduction of energy used by end-use devices and systems. Savings are generally achieved by substituting more technologically advanced equipment to produce the same level of energy services (for example, lighting, water heating, motor drive) with less electricity. Examples include programs that promote the adoption of high-efficiency appliances and lighting retrofit programs through the offering of incentives or direct install services.

### **Energy Efficiency Portfolio Standard (EEPS)**

A goal for reducing the demand for electricity in Hawai'i through the use of energy efficiency and displacement or offset technologies set by state law. The EEPS goes into effect in January 2015. Until then, energy savings from these technologies are included in the calculations for Hawai'i's RPS. The EEPS for Hawai'i provides for a total energy efficiency target of 4,300,000 megawatt-hours per year by the year 2030. To the extent that this target is achieved, this quantity of electric energy will not be served by Hawai'i's electric utilities. Therefore, the projected amount of energy reductions due to energy efficiency are removed from the system energy requirement forecasts used in this PSIPs.

## C. DG PV Market Forecast Methodology

### Calculations and output

#### **Energy Excelerator**

A program of the Pacific International Center for High Technology Research that funds seed-stage and growth-stage startups with compelling energy solutions and immediate applications in Hawai'i, helping them succeed by providing funding, strategic relationships, and a vibrant ecosystem.

#### **Energy Management System (EMS)**

A computer system, including data-gathering tools used to monitor and control electrical generation and transmission.

#### **Expense**

An outflow of cash or other consideration (for example, incurring a commercial credit obligation) from a utility to another person or company in return for products or services (fuel expense, operating expense, maintenance expense, sales expense, customer service expense, interest expense.). An expense might also be a non-cash accounting entry where an asset (created as a result of a Capital Expenditure) is used up (for example, depreciation expense) or a liability is incurred.

#### **Export Model**

A model for DG interconnection in which co-incident self-generation and usage is not metered, excess energy is exported to the grid, and energy is imported to meet additional customer needs.

---

## F

#### **Feeder**

A circuit carrying power from a major conductor to a one or more distribution circuits.

#### **Firm Capacity**

See Capacity, Generating on page C-4.

#### **Feed-In-Tariff (FIT) Program**

A FIT program specific to Hawaiian Electric, under guidelines issued by the Hawai'i Public Utilities Commission, which provides for customers to sell all the electric energy produced to the electric company.

#### **Feed-In-Tariff (FIT)**

The generic term for the rate at which exported DG is compensated by the utility.

### **First-In-First-Out (FiFo)**

The policy for clearing the DG interconnection queues, under which applications are processed in the order in which they were received.

### **Flicker**

An impression of unsteadiness of visual sensation induced by a light stimulus whose luminance or spectral distribution fluctuates with time.

### **Flywheel**

See Storage one page C-31.

### **Forced Outage**

See Outage on page C-23.

### **Forced Outage Rate**

See Outage on page C-23.

### **Fossil Fuel**

Any naturally occurring fuel formed from the decomposition of buried organic matter, essentially coal, petroleum (oil), and natural gas. Fossil fuels take millions of years to form, and thus are non-renewable resources. Because of their high percentages of carbon, burning fossil fuels produces about twice as much carbon dioxide (a greenhouse gas) as can be absorbed by natural processes.

### **Frequency**

The number of cycles per second through which an alternating current passes. Frequency has been generally standardized in the United States electric utility industry at 60 cycles per second (60 Hz). The power system operator strives to maintain the system frequency as close as possible to 60 Hz at all times by varying the output of dispatchable generators, typically through automatic means. In general, if demand exceeds supply, the frequency will drop below 60 Hz; if supply exceeds demand, the frequency will rise above 60 Hz. If the system frequency drops to an unacceptable level (under-frequency), or rises to an unacceptable level (over-frequency), a system failure can occur. Accordingly, system frequency is an important indicator of the power system's condition at any given point in time.

### **Frequency Regulation**

The effort to keep an alternating current at a consistent 60 Hz per second (or other fixed standard).

### **Full-Forced Outage**

See Outage on page C-23.

### **Full Service Customer**

Any residential or commercial customer that imports the entirety of their energy demands from the grid, and does not self-consume or export any energy derived from distributed energy resources co-located with their load.

---

## **G**

### **Generating Capacity**

See Capacity, Generating on page C-4.

### **Generation (Electricity)**

The process of producing electrical energy from other forms of energy; also, the amount of electric energy produced, usually expressed in kilowatt-hours (kWh) or megawatt hours (MWh).

***Nameplate Generation (Gross Generation):*** The electrical output at the terminals of the generator, usually expressed in megawatts (MW).

***Net Generation:*** Gross generation minus station service or unit service power requirements, usually expressed in megawatts (MW). The energy required for pumping at a pumped storage plant is regarded as plant use and must be deducted from the gross generation.

### **Generator (Electric)**

A machine that transforms mechanical, chemical, or thermal energy into electric energy. Includes wind generators, solar PV generators, and other systems that convert energy of one form into electric energy. See also Capacity, Generating on page C-4.

### **Geographic Information System (GIS)**

A computer system designed to capture, store, manipulate, analyze, manage, and present all types of geographical data.

### **Gigawatt (GW)**

A unit of power, capacity, or demand equal to one billion watts.

### **Gigawatt-hour (GWh)**

A unit of electric energy equal to one billion watt-hours.

### **Grandfather**

To exempt a class of customers from changes to the laws or regulations under which they operate.

### **Greenhouse Gases (GHG)**

Any gas whose absorption of solar radiation is responsible for the greenhouse effect, including carbon dioxide, methane, ozone, and the fluorocarbons.

### **Grid (Electric)**

An interconnected network of electric transmission lines and related facilities.

### **Grid Modernization**

The full suite of technologies and capabilities – including the data acquisition capabilities, controlling devices, telecommunications, and control systems – necessary to operate the utility’s modernized electric grid. This includes Advanced Metering Infrastructure (AMI) with two-way communications and all the components to implement an Advanced Distribution Management System/Energy Management System. Additional components might include Volt-VAR Optimization (VVO); demand response; control of DG (curtailment and other); adaptive relaying (dynamic load shed); transformer monitoring; and potentially other advanced analytics, reporting, and monitoring capabilities.

### **Gross Generation**

See Generation (Electricity) on page C-14.

### **Ground Fault Overvoltage**

A transient overvoltage issue that occurs when the neutral of a wye grounded system shifts, causing a temporary over-voltage on the unfaulted phase.

### **Grounding Transformer**

A transformer that provides a safe path to ground.

---

## H

### **Hawai‘i Public Utilities Commission (PUC)**

A state agency that regulates all franchised or certificated public service companies operating in Hawai‘i. The PUC prescribes rates, tariffs, charges and fees; determines the allowable rate of earnings in establishing rates; issues guidelines concerning the general management of franchised or certificated utility businesses; and acts on requests for the acquisition, sale, disposition or other exchange of utility properties, including mergers and consolidations.

### **Hawai'i Revised Statute (HRS)**

The codified laws of the State of Hawai'i. The entire body of state laws is referred to the Hawai'i Revised Statutes; the abbreviation HRS is normally used when citing a particular law.

### **Heat Rate**

A measure of generating station thermal efficiency, generally expressed in Btu per net kilowatt-hour. It is computed by dividing the total Btu content of fuel burned for electric generation by the resulting net kilowatt-hour generation.

### **High Voltage Direct Current (HVDC)**

An electric power transmission system that uses direct current, rather than alternating current, for bulk transmission.

---

|

### **Impacts**

The positive or negative consequences of an activity. For example, there may be negative consequences associated with the operation of power plants from the emission discharge or release of a material to the environment (for example, health effects). There may also be positive consequences resulting from the construction and siting of power plants which could affect society and culture.

### **Impedance**

A measure of the opposition to the flow of power in an AC circuit.

### **Independent Power Producer (IPP)**

Any entity that owns or operates an electricity generating facility that is not included in an electric utility's rate base. This term includes, but is not limited to, co-generators (or combined heat and power generators) and small power producers (including net metered and feed-in-tariff systems) and all other non-utility electricity producers, such as exempt wholesale generators, who sell electricity or exchange electricity with the utility. IPPs are also sometimes referred to as non-utility generators (NUGs).

### **Installed Capacity**

See Capacity, Generating on page C-4.

### **Integrated Demand Response Portfolio Plan (IDRPP)**

A Comprehensive Demand Response program proposal filed by the Companies with the Hawai'i Public Utilities Commission on July 28, 2014.

### **Integrated Interconnection Queue (IIQ)**

Recommendations and plan for implementing and organizing an Integrated Interconnection Queue across all DG programs as directed by the Hawai'i Public Utilities Commission in Order 32053, to be filed on August 26, 2014.

### **Integrated Resource Plan (IRP)**

The plan by which electric utilities identify the resources or the mix of resources for meeting near- and long-term consumer energy needs. An IRP conveys the results from a planning, analysis, and decision-making process that examines and determines how a utility will meet future demands. Developed in the 1980s, the IRP process integrates efficiency and load management programs, considered on par with supply resources; broadly framed societal concerns, considered in addition to direct dollar costs to the utility and its customers; and public participation into the utility planning process.

### **Interconnection Charge**

A one-off charge to DG customers reflecting costs of studies and any potential upgrades (such as transformer upgrades) associated with distributed generation.

### **Interconnection Requirements Study (IRS)**

Studies conducted by the Hawaiian Electric Companies on specific DG interconnection requests that may require mitigation measures to ensure circuit stability.

### **Intermediate Capacity**

See Capacity, Generating on page C-4.

### **Intermittent Renewable Energy**

See Variable Renewable Energy on page C-35.

### **Inverter**

A device that converts direct current (DC) electricity to alternating current (AC) either for stand-alone systems or to supply power to an electricity grid. An appropriately designed inverter can provide dynamic reactive power as well as real power and low voltage ride-through capability. A solar PV system uses inverters to convert DC electricity to AC electricity for use in the grid, or directly by a customer.

### **Islanding**

A condition in which a circuit remains powered by non-utility generation (that is, distributed generation resources) even when the circuit has been disconnected from the wider utility power network.



## K

### **Kilowatt (KW)**

A unit of power, capacity, or demand equal to one thousand watts. The Companies sometimes express the demand for an individual electric customer, or the capacity of a distributed generator in kilowatts. The standard billing unit for electric tariffs with a demand charge component is the kilowatt.

### **Kilowatt-hour (KWh)**

A unit of electric energy equal to one thousand watt-hours. The standard billing unit for electric energy sold to retail consumers is the kilowatt-hour.

---

## L

### **Laterals**

Lines branching off the primary feeder on a distribution circuit.

### **Levelized Cost of Energy (LCOE)**

The price per kilowatt-hour in order for an energy project to break even; it does not include risk or return on investment.

### **Life-Cycle Costs**

The total cost impact over the life of a program or the life of an asset. Life-cycle costs include Capital Expenditures, operation, maintenance and administrative expenses, and the costs of decommissioning.

### **Liquefied Natural Gas (LNG)**

Natural gas that has been cooled until it turns liquid, in order to make storage and transport easier.

### **Live-Line Block Closing**

Restrictions on the re-closing of feeders with interconnected DG systems based on line voltage levels.

### Load, Electric

The term load is considered synonymous with demand. Load may also be defined as an end-use device or an end-use customer that consumes power. Using this definition of load, demand is the measure of power that a load receives or requires.

**Baseload:** The minimum load over a given period of time.

**Connected Load:** The sum of the capacities or ratings of the electric power consuming apparatus connected to a supplying system, or any part of the system under consideration.

### Load Balancing

The efforts of the system operator to ensure that the load is equal to the generation. During normal operating conditions the system operator utilizes load following and frequency regulation for load balancing.

### Load Control Program

A program in which the utility company offers some form of compensation (for example, a bill credit) in return for having permission to control a customer's air conditioner or water heater for short periods of time by remote control.

### Load Forecast

An estimate of the level of future energy needs of customers in an electric system. Bottom-up forecasting uses utility revenue meters to develop system-wide loads; used often in projecting loads of specific customer classes. Top-down forecasting uses utility meters at generation and transmission sites to develop aggregate control area loads; useful in determining reliability planning requirements, especially where retail choice programs are not in effect.

### Load Management DSM

Electric utility or third party marketing programs designed to encourage the utility's customers to adjust the timing of their energy consumption. By coordinating the timing of its customers' consumption, the utility can achieve a variety of goals, including reducing the utility's peak system load, increasing the utility's minimum system load, and meeting unusual, transient, or critical system operating conditions.

### Load Profile

Measurements of a customer's electricity usage over a period of time which shows how much and when a customer uses electricity. Load profiles can be used by suppliers and transmission system operators to forecast electricity supply requirements and to determine the cost of serving a customer.

## C. DG PV Market Forecast Methodology

### Calculations and output

#### Load Shedding

A purposeful, immediate response to curtail electric service. Load shedding is typically used to curtail large blocks of customer load (for example, particular distribution feeders) during an under frequency event when demand for electricity exceeds supply (for example, during the sudden loss of a generating unit).

#### Load Tap Changer (LTC)

A substation controller used to regulate the voltage output of a transformer.

#### Low Sulfur Fuel Oil (LSFO)

A fuel oil that contains less than 500 parts per million of sulfur; about 0.5% sulfur content.

#### Low Sulfur Industrial Fuel Oil (LSIFO)

A fuel oil that contains up to 7,500 parts per million of sulfur; about 0.75% sulfur content. LSIFO is used by Maui Electric and Hawai'i Electric Light if a fuel with lower sulfur content than MSFO is needed.

#### Low Voltages

Voltages above 0.9 per unit that are of concern because these voltages can become an under voltage violation in the future.

---

## M

#### Maalaea Power Plant (MPP)

The largest power plant on Maui, with 15 diesel units, a combined cycle gas turbine, and a combined/simple cycle gas turbine totaling 208.42 MW (net) of firm capacity.

#### Maintenance Outage

See Outage on page C-23.

#### MBtu

A thousand Btu. See also British Thermal Unit on page C-3.

#### Medium Sulfur Fuel Oil (MSFO)

A fuel oil that contains between 1,000 and 5,000 parts per million of sulfur; between 1% and 3.5% sulfur content.

**Megawatt (MW)**

A unit of power, capacity, or demand equal to one million watts. The Companies typically express their generating capacities and system demand in Megawatts.

**Megawatt-hour (MWh)**

A unit of electric energy equal to one million watt-hours. The Companies from time to time express the energy output of their generators or the amount of energy purchased from Independent Power Producers in megawatt-hours.

**MMBtu**

One million Btu. See also British Thermal Unit on page C-3.

**Modern Grid**

An umbrella term used to describe transformed grid, including communications, AMI, ADMS, and DA.

**Must Run Unit**

A baseload generation facility that must run continually due to operational constraints or system requirements to maintain system reliability; typically a large thermal power plant.

---

N

**N-1 Contingency**

A condition that happens when a planned or unplanned outage of a transmission facility occurs while all other transmission facilities are in service. Also known as an N-1 condition.

**Nameplate Generation**

See Generation (Electricity) on page C-14.

**Net Capacity**

See Capacity, Generating on page C-4.

### **Net Energy Metering (NEM)**

A financial arrangement between a customer with a renewable distributed generator and the utility, where the customer only pays for the net amount of electricity taken from the grid, regardless of the time periods when the customer imported from or exported to the grid. Under a NEM arrangement, the customer is allowed to remain connected to the power grid, so that the customer can take advantage of the grid's reliability infrastructure (such as ancillary services provided by generators, energy storage devices, and demand response programs), use the grid as a "bank" for power generated by the customer in excess of the customer's needs, and use the grid as a backup resource for times when the power generated by the customer is less than the customer's needs.

### **Net Generation**

See Generation (Electricity) on page C-14.

### **Nitrogen Oxide (NO<sub>x</sub>)**

A pollutant and strong greenhouse gas emitted by combusting fuels.

### **Nominal Value (Nominal Dollars)**

While a complex topic, at its most basic, value is based on a measure of money over a period of time. Generally expressed in terms of US dollars, nominal value represents a money cost in a given year, usually the current year. As such, nominal dollars can also be referred to as current dollars.

### **Non-Export Model**

A tariff structure governing the interconnection of non-export DG systems.

### **Non-transmission alternatives**

Programs and technologies that complement and improve operation of existing transmission systems that individually or in combination defer or eliminate the need for upgrades to the transmission system.

### **North American Electric Reliability Corporation (NERC)**

An international regulatory authority whose mission is to ensure the reliability of the bulk power system in North America.

## 0

### **Off-Peak Energy**

Electric energy supplied during periods of relatively low system demands as specified by the supplier. In general, this term is associated with electric water heating and pertains to the use of electricity during that period when the overall demand for electricity from our system is below normal.

### **On-Peak Energy**

Electric energy supplied during periods of relatively high system demand as specified by the supplier.

### **Operation and Maintenance (O&M) Expense**

The recurring costs of operating, supporting, and maintaining authorized programs, including costs for labor, fuel, materials, and supplies, and other current expenses.

### **Operating Reliability**

The ability of the electric system to withstand sudden disturbances such as electric short circuits or unanticipated loss of system components.

### **Operating Reserves**

There are two types of operating reserves that enable an immediate or near immediate response to an increase in demand. (See also Reserve on page C-28.)

***Spinning Reserve Service:*** Provides additional capacity from electricity generators that are on-line, loaded to less than their maximum output, and available to serve customer demand immediately should a contingency occur.

***Supplemental Reserve Service:*** Provides additional capacity from electricity generators that can be used to respond to a contingency within a short period, usually ten minutes.

### **Outage**

The period during which a generating unit, transmission line, or other facility is out of service. The following six terms are types of outages or outage-related terms:

***Forced Outage:*** The removal from service availability of a generating unit, transmission line, or other facility for emergency reasons or a condition in which the equipment is unavailable due to unanticipated failure.

**Forced Outage Rate:** The hours a generating unit, transmission line, or other facility is removed from service, divided by the sum of the hours it is removed from service, plus the total number of hours the facility was connected to the electricity system expressed as a percent.

**Full-Forced Outage:** The net capability of main generating units that is unavailable for load for emergency reasons.

**Maintenance Outage:** The removal of equipment from service availability to perform work on specific components that can be deferred beyond the end of the next weekend, but requires the equipment be removed from service before the next planned outage. Typically, a Maintenance Outage may occur anytime during the year, have a flexible start date, and may or may not have a predetermined duration.

**Partial Outage:** The outage of a unit or plant auxiliary equipment that reduces the capability of the unit or plant without causing a complete shutdown. It may also include the outage of boilers in common header installations.

**Planned (or Scheduled) Outage:** The shutdown of a generating unit, transmission line, or other facility, for inspection or maintenance, in accordance with an advance schedule.

---

P

**Partial Outage**

See Outage on page C-23.

**Peak Demand**

The maximum amount of power necessary to supply customers; in other words, the highest electric requirement occurring in a given period (for example, an hour, a day, month, season, or year). For an electric system, it is equal to the sum of the metered net outputs of all generators within a system and the metered line flows into the system, less the metered line flows out of the system. From a customer's perspective, peak demand is the maximum power used during a specific period of time.

**Peaker**

A generation resource that generally runs to meet peak demand, usually during the late afternoon and early evening when the demand for electricity during the day is highest. It is also referred to as a peaker plant or a peaking power plant.

### **Peaking Capacity**

See Capacity, Generating on page C-4.

### **Phase imbalance**

A condition in which there is a voltage imbalance across two or more phases of a multi-phase system.

### **Photovoltaic (PV)**

Electricity from solar radiation typically produced with photovoltaic cells (also called solar cells): semiconductors that absorb photons and then emit electrons.

### **Planned Outage**

See Outage on page C-23.

### **Planning Reserve**

See Reserve on page C-28.

### **Plug-in Electric Vehicle (PEV)**

An umbrella term encompassing all electric or hybrid electric vehicles that can be recharged through an external electricity source.

### **Power**

The rate at which energy is supplied to a load (consumed), usually measured in watts (W), kilowatts (kW), or megawatts (MW).

### **Power Factor**

A dimensionless quantity that measures the extent to which the current and voltage sine waves in an AC power system are synchronized. If the voltage and current sine waves perfectly match, the power factor is 1.0. Power factors not equal to 1.0 result in dissipation of electric energy into losses.

### **Power Purchase Agreement (PPA)**

A contract for the Hawaiian Electric Companies to purchase energy and or capacity from a commercial source (for example, an Independent Power Producer) at a predetermined price or based on pre-determined pricing formulas.



### **Present Value**

The value of an asset, taking into account the time value of money – a future dollar is worth less today. Present value dollars are expressed in a constant year dollars (usually the current year). Future dollars are converted to present dollars using a discount rate. For example, if someone borrows money from you today, and agrees to pay you back in one year in the amount of \$1.00, and the discount rate is 10%, you would be only be willing to loan the other person \$0.90 today. Utility planners use present value as a way to directly compare the economic value of multi-year plans with different future expenditure profiles. Net Present Value is the difference between the present value of all future benefits, less the present value of all future costs.

### **Primary Lines**

The main high-voltage lines of the transmission and distribution network.

### **Proactive Approach**

A forward-looking process governing the forecasting of penetration of DER on distribution circuits, analysis of operational constraints, and pre-emptive mitigation of these constraints.

### **Public Benefits Fee Administrator (PBFA)**

A third-party agent that handles energy efficiency rebates and incentives for the Hawaiian Electric Companies.

### **Pumped Storage Hydro**

See Storage on page C-31.

---

## Q

### **Qualitative**

Consideration of externalities which assigns relative values or rankings to the costs and benefits. This approach allows expert assessments to be derived when actual data from conclusive scientific investigation of impacts are not available.

### **Quantitative**

Consideration of externalities which provides value based on available information on impacts. This approach allows for the quantification of impacts without assigning a monetary value to those impacts (for example, tons of crop loss).

## R

### **Ramping Capability**

A measure of the speed at which a generating unit can increase or decrease output.

### **Rate Base**

The value of property upon which a utility is permitted to earn a specified rate of return as established by a regulatory authority. The rate base generally represents the book value of property used by the utility in providing service and may be calculated by any one or a combination of the following accounting methods: fair value, prudent investment, reproduction cost, or original cost. Depending on which method is used, the rate base includes net cost of plant in service, working cash, materials and supplies, and deductions for accumulated provisions for depreciation, contributions in aid of construction, customer advances for construction, accumulated deferred income taxes, and accumulated deferred investment tax credits.

### **Reactive Power**

The portion of electricity that establishes and sustains the electric and magnetic fields of alternating-current equipment.

### **Real Dollars**

While a complex topic, at its most basic, value is a measure of money over a period of time. Generally expressed in terms of units of US dollars, real dollars represents the true cost inclusive of inflationary adjustments (such as simple price changes which, of course, are usually price increases). Over time, real dollars are a measure of purchasing power. As such, real dollars can also be referred to as constant dollars.

### **Recloser**

A circuit breaker with the ability to reclose after a fault-induced circuit break.

### **Reconductoring**

The process of replacing the cable or wiring on a distribution or transmission line.

### **Regulating Reserves**

The capacity required to maintain system frequency through fast balancing.

### **Reliability**

The degree of performance of the elements of the bulk electric system that results in electricity being delivered to customers within accepted standards and in the amount desired. Reliability may be measured by the frequency, duration, and magnitude of adverse effects on the electric supply. Electric system reliability can be addressed by

considering two basic and functional aspects of the electric system, Adequacy of Supply and System Security. See also System Reliability on page C-33.

### **Renewable Energy Resources**

Energy resources that are naturally replenished, but limited in their constant availability (or flow). They are virtually inexhaustible but are limited in the amount of energy that is available over a given period of time. The amount of some renewable resources (such as geothermal and biomass) might be limited over the short term as stocks are depleted by use, but on a time scale of decades or perhaps centuries, they can likely be replenished.

Renewable energy resources include photovoltaics, biomass, hydroelectric, geothermal, solar, and wind. In the future, they could also include the use of ocean thermal, wave, and tidal action technologies. Utility renewable resource applications include bulk electricity generation, on-site electricity generation, distributed electricity generation, non-grid-connected generation, and demand-reduction (energy efficiency) technologies.

Unlike fossil fuel generation plants (which can be sited where most convenient because the fuel is transported to the plant), renewable energy generation plants must be sited where the energy is available; that is, a wind farm must be sited where a sufficient and relatively constant supply of wind is available. In other words, fossil fuels can be brought to their generation plants whereas renewable energy generating plants must be brought to the renewable energy source.

### **Renewable Portfolio Standard (RPS)**

A goal for the percentage of electricity sales in Hawai'i to be derived from renewable energy sources. The RPS is set by state law. Savings from energy efficiency and displacement or offset technologies are part of the RPS until January 2015, when they will instead be counted toward the new EEPS. The current RPS calls for 10% of net electricity sales by December 31, 2010; 15% of net electricity sales by December 31, 2015; 25% of net electricity sales by December 31, 2020; and 40% of net electricity sales by December 31, 2030.

### **Repowering**

A means of permanently increasing the output and/or the efficiency of conventional thermal generating facilities.

### **Reserve**

There are two types of reserves:

***Operating Reserve:*** That capability above firm system demand required to provide for regulation, load forecasting error, equipment forced and scheduled outages, and local area protection. See also Operating Reserves on page C-23.

**Planning Reserve:** The difference between a control area's expected annual peak capability and its expected annual peak demand expressed as a percentage of the annual peak demand.

### **Reserve Margin (Planning)**

The amount of unused available capability of an electric power system at peak load for a utility system as a percentage of total capability. Such capacity may be maintained for the purpose of providing operational flexibility and for preserving system reliability.

### **Residential Direct Load Control (RDLC)**

A demand response program that offers incentives to customers who allow the Hawaiian Electric Companies to install a load control switch on residential electric water heater, so that the load can be curtailed remotely by the utility during times of system need.

### **Resiliency**

The ability to quickly locate faults and automatically restore service after a fault, using FLISR (Fault Location, Isolation, & Service Restoration).

### **Retail Rate**

The rate at which specific classes of customers compensate the utility for grid electricity.

### **Reverse Flow**

The flow of electricity from the customer site onto the distribution circuit or from the distribution circuit through the substation to higher voltage lines. Also called backfeed.

### **Rule 14H**

The Hawaiian Electric Company rules governing service connections and facilities on a customer's premises.

### **Rule 18**

The Hawaiian Electric Company rules governing Net Energy Metering.

---

## S

### **Schedule Q**

The tariff structure that governs Hawaiian Electric purchases from qualifying facilities 100kW or less

### **Scheduled Outage**

See Outage on page C-23.

### **Secondary Lines**

Low voltage distribution lines directly serving customers.

### **Service Charge**

A fixed customer charge intended to allocate the cost of servicing the grid to all customers, regardless of capacity needs.

### **Service Level Issue**

Any issue arising at the point of service provision to customers, including traditional utility service and grounding transformer overloads caused by DG.

### **Service Transformer**

A transformer that performs the final voltage step-down from the distribution circuit to levels usable by customers.

### **Simple-Cycle Combustion Turbine (SCCT)**

A generating unit in which the combustion turbine operates in a stand-alone mode, without waste heat recovery.

### **Single-Train Combined Cycle (STCC)**

See Combined Cycle on page C-5.

### **Small Business Direct Load Control (SBDLC)**

A demand response programs that allows the electric utility to curtail load without intervention of an operator at the end user's (customer's) premises. For example, the utility may install a load control switch on an electric water heater or air-conditioning unit, so that the load can be controlled remotely by the utility during times of system need.

### **Smart Grid**

A platform connecting grid hardware devices to smart grid applications, including VVO, AMI, Direct Load Control, and Electric Vehicle Charging.

### **Smart Inverter Working Group (SIWG)**

A working group created by the California Public Utilities Commission to propose updates to the technical requirements of inverters.

### **Spinning Reserve Service**

See Operating Reserves on page C-23.

### **Standard Interconnection Agreement (SIA)**

Rules governing interconnection of distributed generation systems.

### Standby Charge

A fixed charge intended to recover significant backup generation facilities the utility must maintain to ensure grid reliability in the event of widespread DG outages.

### Static VAR Compensator

A device used provide reactive power in order to smooth voltage swings.

### Steady-State Conditions

Conditions governing normal grid operations; contrasted with transient conditions.

### Steam Turbine (ST)

A turbine that is powered by pressurized steam and provides rotary power for an electrical generator.

### Storage

A system or a device capable of storing electrical energy to serve as an ancillary service resource on the utility system and/or to provide other energy services. Three major types of energy storage are relevant for consideration in Hawai'i:

**Battery:** An energy storage device composed of one or more electrolyte cells that stores chemical energy. A large-scale battery can provide a number of ancillary services, including frequency regulation, voltage support (dynamic reactive power supply), load following, and black start as well as providing energy services such as peak shaving, valley filling, and potentially energy arbitrage. Also referred to as Battery Energy Storage System (BESS).

**Flywheel:** A cylinder that spins at very high speeds, storing rotational kinetic energy. A flywheel can be combined with a device that operates either as an electric motor that accelerates the flywheel to store energy or as a generator that produces electricity from the energy stored in the flywheel. The faster the flywheel spins, the more energy it retains. Energy can be drawn off as needed by slowing the flywheel. A large flywheel plant can provide a number of ancillary services including frequency regulation, voltage support (dynamic reactive power supply), and potentially spinning reserve.

**Pumped Storage Hydro:** Pumped storage hydro facilities typically use off-peak electricity to pump water from a lower reservoir into one at a higher elevation storing potential energy. When the water stored in the upper reservoir is released, it is passed through hydraulic turbines to generate electricity. The off-peak electrical energy used to pump the water uphill can be stored indefinitely as gravitational energy in the upper reservoir. Thus, two reservoirs in combination can be used to store electrical energy for a long period of time, and in large quantities. A modern

## C. DG PV Market Forecast Methodology

### Calculations and output

pumped-storage facility can provide a number of ancillary services, such as frequency regulation, voltage support (dynamic reactive power), spinning and non-spinning reserve, load following and black start as well as energy services such as peak shaving and energy arbitrage.

#### **Sulfur Oxide (SO<sub>x</sub>)**

A precursor to sulfates and acidic depositions formed when fuel (oil or coal) containing sulfur is combusted. It is a regulated pollutant.

#### **Substation**

A small building or fenced in yard containing switches, transformers, and other equipment and structures for the purpose of stepping up or stepping down voltage, switching and monitoring transmission and distribution circuits, and other service functions. As electricity gets closer to where it is to be used, it goes through a substation where the voltage is lowered so it can be used by customers such as homes, schools, and factories.

#### **Substation Transformer**

Substation-sited transformers used to change voltage levels between transmission lines, or between transmission lines and distribution lines.

#### **Supervisory Control and Data Acquisition (SCADA)**

A system used for monitoring and control of remote equipment using communications networks.

#### **Supplemental Reserve Service**

See Operating Reserves on page C-23.

#### **Supply-Side Management**

Actions taken to ensure the generation, transmission, and distribution of energy are conducted efficiently. Supply-side generation includes generating plants that supply power into the electric grid.

#### **Switching Station**

An electrical substation, with a single voltage level, whose only functions are switching actions.

#### **Synchronous Condensers**

Devices used to modulate the voltage or power factor of transmission lines. Synchronous condensers typically provide dynamic reactive power support, and are deployed only where dynamic reactive power support needs to be maintained at a particular location.

### **System**

The utility grid: a combination of generation, transmission, and distribution components.

### **System Average Interruption Duration Index (SAIDI)**

The average outage duration for each customer served. A reliability indicator.

### **System Average Interruption Frequency Index (SAIFI)**

The average number of interruptions that a utility customer would experience. A reliability indicator.

### **System Reliability**

Broadly defined as the ability of the utility system to meet the demand of its customers while maintaining system stability. Reliability can be measured in terms of the number of hours that the system demand is met.

### **System Security**

The ability of the electric system to withstand sudden disturbances such as electric short circuits or unanticipated loss of system elements.

---

## T

### **Tariff**

A published volume of rate schedules and general terms and conditions under which a product or service will be supplied.

### **Thermal Loading**

The maximum current that a conductor can transfer without overheating.

### **Time-of-Use (TOU) Rates**

The pricing of electricity based on the estimated cost of electricity during a particular time block. Time-of-use rates are usually divided into three or four time blocks per twenty-four hour period (on-peak, mid-peak, off-peak and sometimes super off-peak) and by seasons of the year (summer and winter). Real-time pricing differs from TOU rates in that it is based on actual (as opposed to forecasted) prices which may fluctuate many times a day and are weather-sensitive, rather than varying with a fixed schedule.

### **Total Resource Cost (TRC)**

A method for measuring the net costs of a conservation, load management, or fuel substitution program as a resource option, based on the total costs of the program, including both the participants' and the utility's costs.



### **Transformer**

A device used to change voltage levels to facilitate the transfer of power from the generating plant to the customer. A step-up transformer increases the voltage (power) of electricity while a step-down transformer decreases it.

### **Transient Condition**

An aberrant grid condition that begins with an adverse event and ends with the return to steady-state conditions (stable voltage, connection of all loads).

### **Transient Over Voltage (TrOV)**

A transient issue characterized by a sudden spike in voltage above steady-state conditions on a circuit, or on a subset or component of a circuit.

### **Transmission and Distribution (T&D)**

Transmission lines are used for the bulk transfer of electric power across the power system, typically from generators to load centers. Distribution lines are used for transfer of electric power from the bulk power level to end-users and from distributed generators into the bulk power system. In the Hawaiian Electric Companies, standard transmission voltages are 138,000 volts (Hawaiian Electric system only) and 69,000 volts (Hawaiian Electric, Maui Electric, Hawai'i Electric Light). Distribution voltage is 23,000 volts (Maui Electric) and 13,200 volts (all systems).

### **Transmission System**

The portion of the electric grid that transports bulk energy from generators to the distribution circuits.

### **Two-Way Communications**

The platform and capabilities that are required to allow bi-directional communication between the utility and elements of the grid (including customer-sited advanced inverters), and control over key functions of those elements. The platform must contain monitor and control functions, be TCP/IP addressable, be compliant with IEC 61850, and provide cyber security at the transport and application layers as well as user and device authentication.

---

## U

### **Ultra Low Sulfur Diesel (ULSD)**

A diesel fuel that contains less than 15 parts per million of sulfur.

### **Under Frequency Load Shedding (UFLS)**

A system protection scheme used during transient adverse conditions to balance load and generation.

### **Under Voltage Load Shedding (UVLS)**

A system protection scheme used during low voltage conditions to avoid a voltage collapse.

### **Under Voltage Violation**

Bus voltage less than 0.9 per unit.

### **United States Department of Defense (DOD)**

An executive department of the U.S. government responsible for coordinating and supervising all agencies and functions of the Federal government that are concerned directly with national security and the armed forces.

### **United States Department of Energy (DOE)**

An executive department of the U.S. government that is concerned with the United States' policies regarding energy, environmental, and nuclear challenges.

### **United States Environmental Protection Agency (EPA)**

An executive department of the U.S. government whose mission is to protect human health and the environment.

### **University of Hawai'i Economic Research Organization (UHORO)**

The economic research organization at the University of Hawai'i, which is a source for information about the people, environment, and Hawai'i and the Asia-Pacific economies, including energy issues.

---

## V

### **Variable Renewable Energy**

A generator whose output varies with the availability of its primary energy resource, such as wind, the sun, and flowing water. The primary energy source cannot be controlled in the same manner as firm, conventional, fossil-fuel generators. Specifically, while a variable generator (without storage) can be dispatched down, its output cannot be guaranteed 100% of the time when needed. However, the primary energy source may be stored for future use, such as with solar thermal storage, or when converted into electricity via storage technologies. Also referred to as intermittent and as-available renewable energy.

## C. DG PV Market Forecast Methodology

### Calculations and output

#### **Voltage**

Voltage is a measure of the electromotive force or electric pressure for moving electricity.

#### **Voltage Collapse**

The sudden and large decrease in the voltage that precipitates shutdown of the electrical system.

#### **Voltage Regulation**

A measure of change in the voltage magnitude between the sending and receiving end of a component, such as a transmission or distribution line.

#### **Voltage Regulator Controller**

A device used to monitor and regulate voltage levels.

#### **Volt/VAR control**

Control over voltage and reactive power levels.

#### **Volt/VAR Optimization (VVO)**

The process of monitoring voltages at customer premises through an AMI system, and optimizing them using reactive power control and voltage control capabilities.

---

## W

#### **Watt**

The basic unit of measure of electric power, capacity, or demand. It is a derived unit of power in the International System of Units (SI), named after the Scottish engineer James Watt (1736–1819).

## D. DGIP Supporting Documents Attachment Listing

**Table D-1** below lists the various attachments referred to throughout the DGIP. All attachments listed were submitted with the DGIP, but in a separate zip file named “DGIP Attachments”.

Attachment Letter	Attachment Name
A1	Attachment A-1_Deliverable2 1_DBEDT_01242014_DN_final
A2	Attachment A-2_Deliverable2 2_DBEDT_01242014_DN_final
A3	Attachment A-3_Deliverable3_DBEDT_051214_V5_Final
A4	Attachment A-4_Deliverable4_DBEDT_V5_Final_062914_v2
A5	Attachment A-5_ExecSum_FinalReport_DBEDT_063014_v3
B	Attachment B_MECO_Curtailment_Red_Plan_Report_June30
C	Attachment C_Ex 3 HELCO_PV_Penetration_Final_report-4-20-14
D	Attachment D_NREL_Analysis of High-Penetration
E-1	Attachment E-1_TSF-132 Circuit Penetration Study_Final
E-2	Attachment E-2_TSF-158_TSF-159 Circuit Penetration Study_Final
E-3	Attachment E-3_H111_circuit Penetration Study_Final
E-4	Attachment E-4_H47-2_Circuit Penetration Study_Final
F	Attachment F_Data, Model and Criteria
G-1	Attachment G1_HECO DGIP Circuit List 2014-8-19 v2CIRCUITS
G-2	Attachment G2_HECO DGIP Circuit List 2014-8-19 v2PROJECTS
G-3	Attachment G3_HECO DGIP Circuit List 2014-8-19 v2SUBXFMRs
H	Attachment H_List of Potential Mitigation Measures Table

Table D-1. DGIP Supporting Documents Attachment Listing

**D. DGIP Supporting Documents Attachment Listing**

This Page Intentionally Left Blank

# Hawaii Grid Cluster Evaluation Project

## Cluster Evaluation Methodology

**HAWAIIAN ELECTRIC COMPANY**

January 8, 2014



Hawaiian Electric  
Maui Electric  
Hawai'i Electric Light

## **Cluster Evaluation Methodology**

**Task 2, Subtask 1: Report on cluster/circuit(s) identification, including representative attributes of circuits.**

**Submitted to the  
Hawaii State Energy Office  
Hawaii Department of Business, Economic Development and Tourism**

**by**

*Contributing Authors*

Hawaiian Electric Company:

Dora Nakafuji,  
Thomas Aukai,  
Amra Brightbill

DNV:

Jonathan Flinn,  
Ronald Davis

**January 2014**

### **Disclaimer**

This report was prepared as an account of work sponsored by an agency of the United States Government. Neither the United States nor any agency thereof, nor any of their employees, makes any warranty, express or implied, or assumes any legal liability or responsibility for the accuracy, completeness, or usefulness of any information, apparatus, product, or process disclosed, or represents that its use would not infringe privately owned rights. Reference herein to any specific commercial product, process, or service by trade name, trademark, manufacturer, or otherwise does not necessarily constitute or imply its endorsement, recommendation, or favoring by the United States Government or any agency thereof. The views and opinions of authors expressed herein do not necessarily state or reflect those of the United States Government or any agency thereof.

### **Acknowledgements**

This material is based upon work supported by the Department of Energy and the State of Hawaii Department of Business, Economic Development and Tourism under award number DE-EE0005354/0005. Efforts build on methodology utility proprietary models and work developed in collaboration with western utility partners under prior grant award from the California Public Utilities Commission's California Solar Initiative (CSI). No utility customer, grid data or business sensitive information is released under this work and all information pertaining to the utilities and proprietary software remain the possession of the utilities.



## TABLE OF CONTENTS

1.0	INTRODUCTION.....	4
2.0	METHODOLOGY.....	5
2.1	Organization and Terminology.....	6
2.2	Electrical Cluster Selection Process.....	8
3.0	INPUT DATA AND DATA REQUIREMENTS.....	14
3.1	Feeder Model.....	14
3.2	Load Data.....	15
3.3	Quality Checks.....	15
3.4	Calculation of Load from Demand.....	17
4.0	VALIDATION PROCESS.....	18
5.0	NEXT STEPS.....	19

## 1.0 INTRODUCTION

As distributed generation (DG) grows within the residential, commercial and industrial communities to help serve their electrical needs, utilities are seeing a transformation of the electrical grid from the traditional central power station to more distributed, local generation using a variety of technologies. Common types of distributed generation (DG) include rooftop photovoltaic (PV), small wind turbines, small diesel generators and small hydro plants. Instead of the one-way, central utility power station serving load centers, utilities soon need new techniques and capabilities to monitor and balance a new system comprised of numerous distributed generators and loads including variable renewables, roof-top-PV systems, microgrids and other storage or load management technologies.

Over the past several years, the Hawaii grids have seen exponential growth in PV installations and similar to states like California and Arizona, Hawaiian utilities on the islands are contending with some of the highest DG penetration levels in the nation. On Oahu, many of the feeders have installed DG in excess of 50% up to 100% of feeder maximum loads. Some of these circuits are producing so much local generation that the excess production from all the systems is backfeeding onto the main transmission grid or basically generating more than needed on the local feeder. Significant levels of backfeed have raised concerns for the utility industry as the traditional infrastructure was designed to handle and protect for one-way flow.

Aggressive new interconnection policies to enable customer interconnection have been implemented by Hawaiian Electric Companies servicing the islands of Oahu, Maui, Molokai, Lanai and the Big Island of Hawaii. However, uncertainties on system operational impacts, risks and distribution maximum limits at these penetration levels remain pressing issues.

In 2010, the California Public Utilities Commission funded the Sacramento Municipal Utility District (SMUD) in partnership with Hawaiian Electric Company to develop new modeling and assessment techniques pertinent to evaluating and assessing impacts/concerns related to high penetrations of PV at the distribution level. This High Penetration PV Initiative (Hi-PV) was funded under the California Solar Initiative and resulted in the development of a Proactive Modeling and Analysis Approach for reviewing and evaluating impacts on high penetration feeders (<http://www.calsolarresearch.org/solicitation1-smud.html>). The proactive methodology was also unanimously adopted and encouraged by the Reliability Standards Working Group (RSWG), PV Subgroup, convened by the Hawaii Public Utilities Commission (<http://puc.hawaii.gov/wp-content/uploads/2013/04/RSWG-Facilitators-Report.pdf>).

This effort supports application and demonstration of a comprehensive Proactive Modeling approach to conduct reliable, cluster-level and distribution circuit based analysis that can help streamline DG assessment and proactively review high penetration DG impacts. Specifically, the DG systems on Oahu are comprised mainly of customer sited, rooftop PV systems and larger land-based PV systems connected to the electrical grid at the 12kV distribution level. This report provides an overview of the Proactive Modeling methodology, clustering process, circuit selection and applicable definitions as applied on the island of Oahu. Similar methodology can be applied for other areas and regions.

## 2.0 METHODOLOGY

To understand the impacts PV is having on the grid, proactive monitoring and simulation-based studies of the distribution (customer level electric lines, typically rated at 12kV or lower), transmission and subtransmission (higher voltage lines that delivers electricity down to the distribution circuits) systems are needed. The distribution system represents a network of lower voltage (i.e. 12kV) electrical lines that connect at utility substations to higher voltage transmission and subtransmission lines. Similar to a hub and spoke architecture, the Oahu system is comprised of hundreds of distribution feeders (spokes) connected at substations (hubs). Voltage rating levels (12kV, 46kV, 138kV) which indicate the electrical transmission capability determine whether the lines are considered distribution or transmission/subtransmission. The utility proprietary models are used to represent and simulate conditions on over 400+ distribution lines on the Oahu system.

Using the enhanced models that account for DG as generation and new solar irradiance data collected in the local area, the proactive modeling approach is helping to streamline and efficiently produce study results for hundreds of distribution circuits on Oahu, and to effectively organize the results to suggest common solutions to allow distributed PV to safely and reliably interconnect to the grid and also inform planners and operators on potential DG impacts on the system.

In other words, the ProActive Approach looks at the amount of PV electricity on a distributed circuit, the location of the nearby PV systems on that circuit, and the solar radiance for that area. By combining these pieces of information, grid planners can have access to how the grid reacts to increased PV in specific areas and identify potential problem areas for further evaluation for example in IRS studies. See (Figure 2.1).

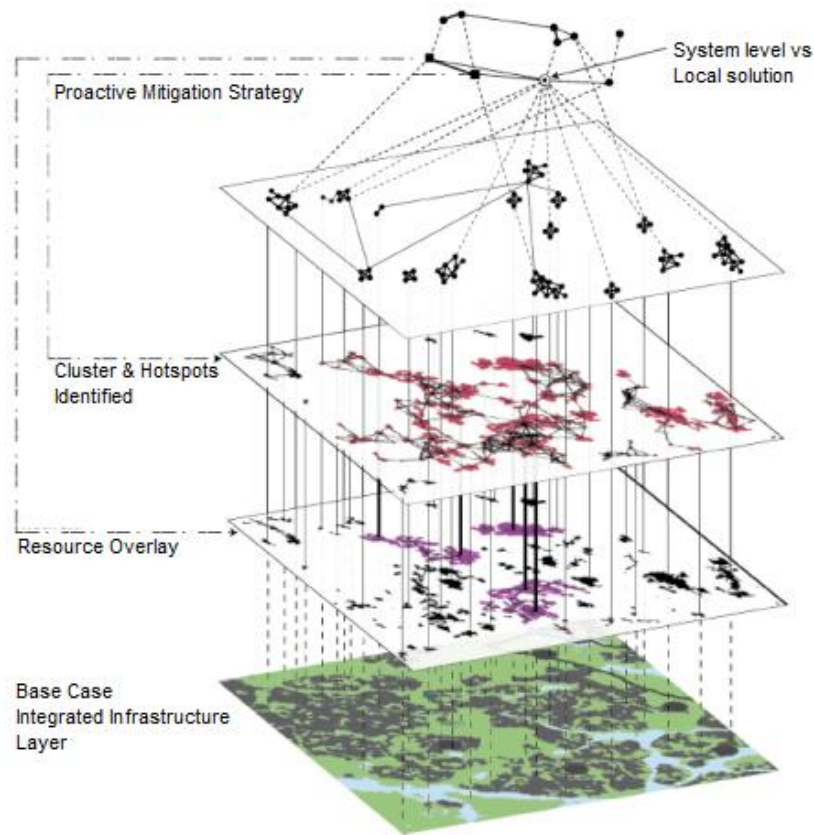

Figure 2.1. Graphical Representation of the Proactive Modeling Approach.

## 2.1 Organization and Terminology

As part of the modeling effort, the distribution circuits were grouped into 12 regional and electrical clusters to help systematically organize and streamline the analysis process. Definitions for the clusters are provided below and illustrated in Figures 2.2 through 2.3.

1. *A Distribution Circuit* is used to provide electricity to customers on various levels, including residential homes, commercial buildings and industrial parks, amongst other load types (Figure 2.2). On Oahu, the majority of PV installations are on the distribution circuit in the form of rooftop PV systems and ground mounted installations. A PV system may also be connected at the subtransmission level depending on the size and interconnection requirements.
2. *An Electrical Cluster* is defined as a subtransmission feeder, down to the distribution substations and the associated distribution circuits that are fed from these substations (Figure 2.2). Electrical Clusters are identified to study a single subtransmission feeder and all electrically connected distribution circuits to study the effects of PV on each distribution circuit as well as the aggregate effects on the subtransmission feeder to obtain a complete picture of the aggregated impacts. A subtransmission feeder provides a path to transmit electricity from the system level

(138kV transmission line on Oahu) down to distribution level (distribution substations, distribution circuits 12kV and lower). For Oahu, the subtransmission feeders are rated at 46kV.

3. *Regional Clusters* are geographically organized areas grouping electrical clusters and may share similar terrain, solar availability and weather patterns. Twelve (12) Regional Clusters were identified for the island of Oahu. Creating Regional Clusters help to organize the electrical clusters and distribution circuits for analysis. See Figure 2.3 for an overview of the Regional Clusters on Oahu.

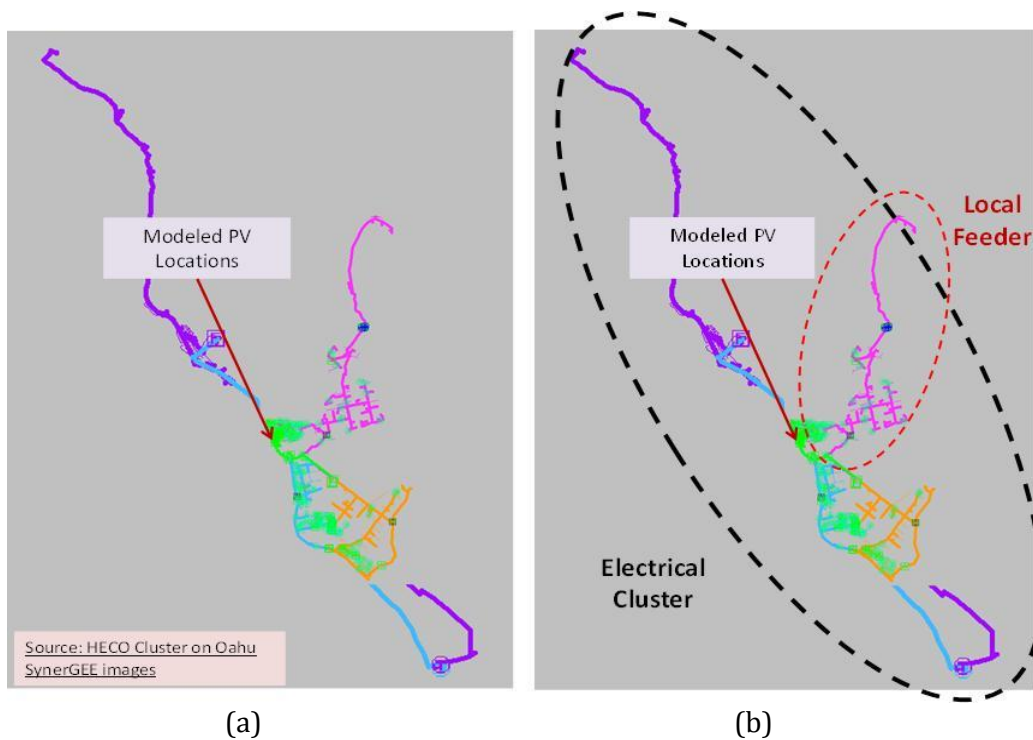

Figure 2.2. a) Geographical representation of distribution feeders, b) comparison of the distribution feeder (electrical lines circled in red) and electrical cluster (all lines circled in black).

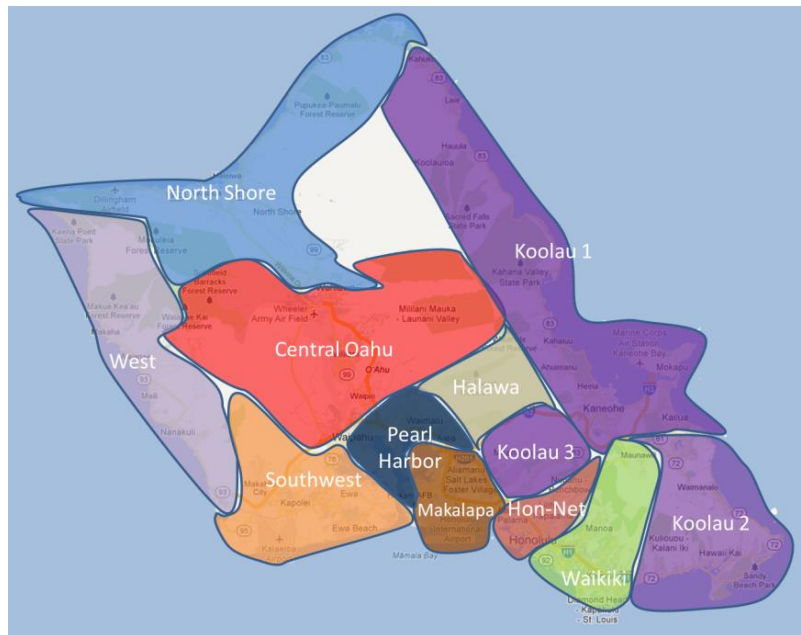

Figure 2.3. 12 Regional Clusters for Oahu.

## 2.2 Electrical Cluster Selection Process

The applicability of results from any simulation-based analysis is dependent on the upfront work in preparing the models, review of the data and selection of appropriate study areas. For the proactive modeling effort, a process is recommended to review the study area and ensure appropriate information is available prior to conducting any evaluations and is described in this section.

The Cluster/Circuit selection for this project was determined by the following attributes:

- PV Penetration and Type of Installations
- Circuit Type
  - Residential
  - Commercial
  - Industrial
- Circuit Length
- Data Availability
  - Solar Resource Data (Irradiance)
  - Substation Load Data

### **Circuit PV Penetration and Type of Installations**

Circuit PV Penetration is a calculated percentage that identifies how much PV is on a distribution circuit. The calculation uses both the Daytime Minimum Load (DML) of a circuit and the amount of PV installed on that specific circuit.

Hawaiian Electric Company

Task 2 Deliverable – Cluster Evaluation Methodology

The Daytime Minimum Load (DML) is defined as the lowest usage of electricity during the daytime hours between 10am and 2pm. This 10am to 2pm daytime period is generally when PV will produce the highest amount of electricity due to the high availability of solar resource. Dividing the installed amount of PV (kW) over the DML (kW) gives the ratio of PV on a specific circuit. The DML is emerging as a new time period of interest for utilities to study as PV systems have the potential to produce electricity at the maximum output levels. During this period, especially on weekdays, high PV output can have the most impact on a circuit as the demand for electricity can be relatively low. For instance, with many residential customers not at home during the daytime, the PV generated electricity on the customer’s roof is not being used by that customer.

PV generation on a circuit is calculated using the measured solar irradiance ( $W/m^2$ ), installed PV on the circuit and the estimated power production curve for the PV system for a given day of interest (e.g. low load day, cloudy day, sunny day). Total load (gross load) on a circuit can then be derived as the measured circuit load (net load) plus the load served by the PV generation on the circuit which can vary depending on the solar condition for the day. Figure 2.4 shows how a clear day and cloudy day can affect the PV generating resource (shown in blue) and thus the net load (shown in green) but the gross load (shown in red) stays relatively consistent for this circuit.

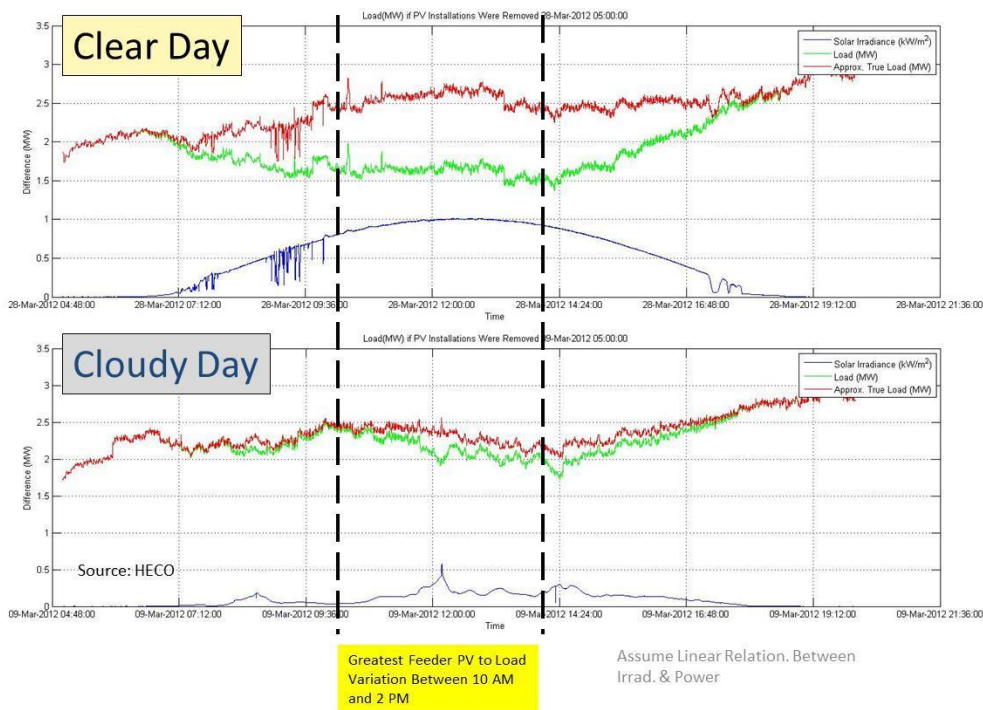

Figure 2.4. Example highlighting PV generated during the daylight hours.

In Hawaii, customers have a number of options for self-generation and selling power to the grid (Table 2.1). Tracking the type, size and location of the PV systems on both the distribution and sub-transmission circuit are also of interest as these attributes can have major impact on how the electricity flows onto the grid.

Table 2.1. Summary of Different Types of Installations

Type of System	Size	Location
Net Energy Metering (NEM)	<ul style="list-style-type: none"> <li>▪ 10kW and smaller</li> <li>▪ Greater than 10kW up to 100kW</li> </ul>	<ul style="list-style-type: none"> <li>▪ Distribution connected</li> <li>▪ Customer rooftop</li> </ul>
Standard Interconnection Agreement (SIA)	<ul style="list-style-type: none"> <li>▪ Up to 1MW</li> </ul>	<ul style="list-style-type: none"> <li>▪ Distribution connected,</li> <li>▪ Commercial and industrial rooftop</li> </ul>
Feed-in-Tariff (FIT) (Tier size levels on Oahu)	<ul style="list-style-type: none"> <li>▪ Tier 1 (100kW and smaller)</li> <li>▪ Tier 2 (100kW up to 1MW)</li> <li>▪ Tier 3 (greater than 1MW up to 5 MW)</li> </ul>	<ul style="list-style-type: none"> <li>▪ Distribution or subtransmission connected</li> <li>▪ Rooftop and ground-mount</li> </ul>
Power Purchase Agreement (PPA)	Various (typically 5 MW or greater based)	<ul style="list-style-type: none"> <li>▪ Subtransmission, transmission</li> <li>▪ Ground-mount</li> </ul>

- NEM and SIA programs are available to customers wanting to generate their own electricity to supply existing load, and lower their electricity usage from the grid. NEM installations are designed to match the customer’s usage of electricity, but during low usage may generate electricity back onto the grid that is credited by the utility.
- SIA installations are similar to NEM installations, but as the system installation sizes are typically larger for commercial and industry uses, may have additional design features to prevent the backflow of electricity back onto the grid.
- FIT installations are developed to sell electricity back to the utility and do not serve a dedicated load. Depending on the size, these installations will have additional design requirements including monitoring, controls and communication.
- PPA installations are large developments that are designed to provide power to the utility similar to a conventional generation facility. Both wind and solar generation facilities exist in Hawaii.



The type, size and location of the PV installations as described above can impact the electrical characteristics of a circuit and contribute to voltage, frequency, outage and other conditions on the grid. Small individual customer systems on their own have typically not been a major concern at the distribution level, however the individual systems, in aggregate, are becoming as large as some of the utility generation. Understanding the makeup of PV on a circuit also helps to forecast future PV growth scenarios to determine circuit limitations and possible mitigating solutions. Figure 2.5 shows how a circuit may be comprised of varying types of PV installations.

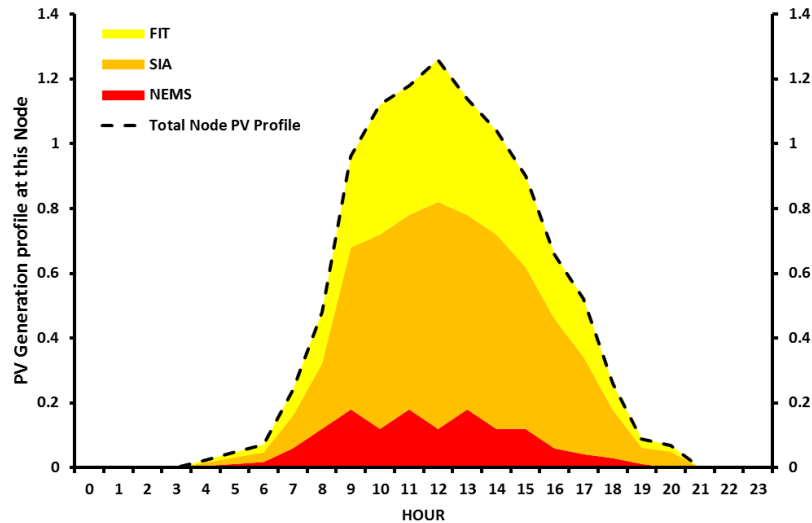

Figure 2.5. Example of the aggregate of PV types on a circuit.

### **Circuit Type**

Electricity usage varies with the type of customers on the circuit, and is used to provide more detailed input to models. Also, determining the type of circuit helps determine the type and level of load monitoring that is needed for data collection and model validation. Example: Commercial-heavy circuits may require vault-located load monitors at Commercial PV site to understand impacts such as VAR consumption, power factor effects and harmonics to name a few. It is important to study varying types of circuits to understand the impacts generated from specific types of PV installations in relation to the type of customer load. The circuit types are described as follows:

- Residential
- Commercial
- Industrial
- Combination

### Circuit Length

Circuit Length is important to understand circuit issues related to PV placement on the circuit. As part of the proactive modeling process, geographical representations of the circuits are now available through the enhanced distribution models. This enables visualization of not only how the circuit physically routes but provides additional insight on the placement of the PV installations or other resources connected to the grid. For solar resources, physical location can have a significant impact on how the installation produces electricity and how the installation impacts the circuit. Besides having more diversity of PV placement on a longer circuit, longer circuits also are more susceptible to voltage issues at the end of the line (further from source/transformer). Figure 2.7 compares a traditional single-line view of the circuits to a geographical view.

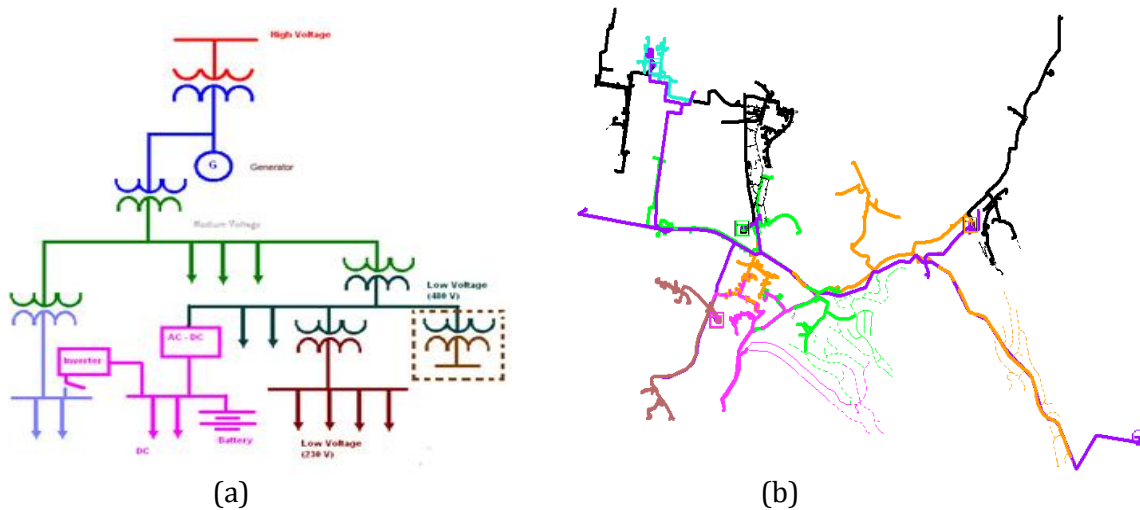

Figure 2.6 a) Typical single-line view compare to b) geographical view of distribution circuits.

### Data Availability

Simulation model validation is reliant on the measured circuit load data at the substation, customer sites and resource conditions local to the study area (e.g. solar irradiance data). Figure 2.7 shows various field monitoring devices installed by Hawaiian Electric to gather load and solar data. A minimum of one year of continuous data is recommended to use for building representative load and solar profiles for the study area, so both load and solar monitoring data should be available (Figure 2.8). Fifteen minute resolution load is sufficient for steady state analysis however for any dynamic analysis, higher resolution is preferred. One minute solar data is preferred; however continuous data over a 1 to 3 year period will help capture not only diurnal, seasonal but also global cycles.

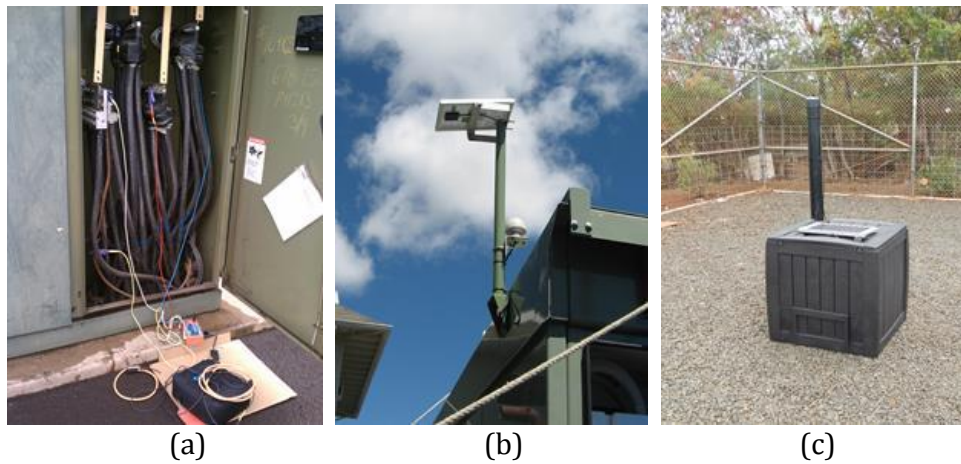

Figure 2.7 Various load and solar field monitoring devices to support DG integration

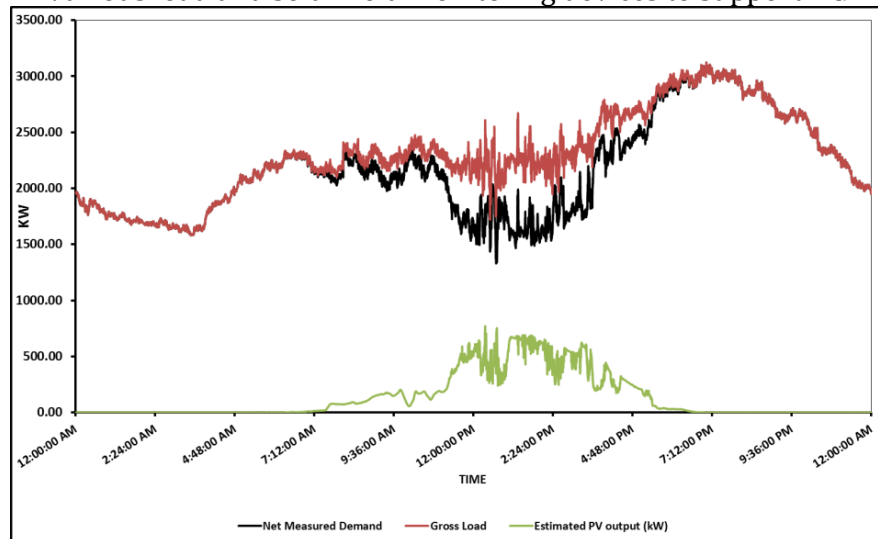

Figure 2.8 Example of high resolution measured load and solar for a feeder.

Circuits are prioritized and selected for study based heavily on data already available to develop and validate the models in building accurate maps of PV penetration levels to circuit issues. All distribution circuits for Oahu were initially screened for data availability, organized into appropriate clusters for validation and then prioritized.

Three classifications for load and solar data availability were created to identify what clusters were best available for validation and prioritization. Circuit clusters were organized and prioritized based on the classification for data availability (Load/Solar) shown in Table 2.2

Table 2.2. Data Availability Classifications

Classification	Description
<b>Good Data</b>	At least 75% of circuits have available measured load data and solar resource data for study area
<b>Moderate Data</b>	Less than 75% of circuits have available measured load data and little solar resource data near study area
<b>Limited Data</b>	Less than 50% of circuits have available measured load data and little solar resource data near study area
<b>No Data</b>	Load data and/or solar resource data not available

Based on these classifications, circuits and clusters were also prioritized for monitoring and data collection. This process provided one of the first reviews for feeders with limited and no data, and is helping to establish a more timely and systematic procedure for circuit reviews that can help streamline interconnection reviews and studies.

### 3.0 INPUT DATA AND DATA REQUIREMENTS

Modeling efforts are heavily dependent on the quality of the model and the details represented in the model. Considerable time and effort was spent organizing and cleaning the distribution model of the Oahu system so studies can be conducted more routinely and efficiently. This section describes the various types of input data required for the study and the application of the data in the modeling analysis.

#### 3.1 Feeder Model

The feeder model is the geographical layout of the system, the equipment specifications and the connected load on the circuits. This is extracted by the utility from their respective GIS software, and delivered in two databases – one for distribution feeders and one for sub-transmission feeders. The user then extracts the subtransmission and distribution feeder components required for each study from the larger datasets.

After the feeder model is extracted, data checks are required to ensure that the analysis runs satisfactorily:

- Conductor and equipment specifications must be consistent with naming used in the utility equipment database. Any inconsistent specifications in the database are corrected or assigned to the closest equivalent;
- Sub-station connections and equipment are checked for connectivity and correct settings; and,
- Peak load analysis is performed with PV generators off to identify existing line loading violations. Any violations are reviewed with utility staff, and if necessary, the conductor specification is corrected.

The existing PV case is then verified based on information in the Locational Value Map (“LVM”) database, provided by the utility. The LVM database provides details on total existing and queued PV capacity for each feeder, and the address and size of each individual PV generator installation. This is verified against the PV generator locations and sizes in the model and, where necessary, PV generators are added or the size altered. Finally, the future PV cases are added. New PV generators are added to locations with existing connected load in the model, and there is not an existing PV generator. The future PV penetration is sized such that the total of existing plus future PV capacity equals 1.5 times the feeder’s historical peak load as provided by the utility. Various PV penetration scenarios can be conducted with PV penetration up to 150% of peak load (although at present the analysis is only carried out up to 135% of peak load, as described later). In some cases there are circuits for which a feeder model is unavailable. In these cases, the feeder is modeled as a single line section of nominal length, with a generator and a load. Results are not reported for these feeders.

### 3.2 Load Data

Load profiles are required for the maximum daytime peak and minimum daytime load days. These are days with high PV generation and either minimum or maximum load between the hours of 10am and 2pm. These day profiles form the boundary conditions of the analysis, and it is assumed that all other days fall within these two conditions. The load profiles are provided by the utility, and several criteria must be observed in the selection of the peak and minimum load days profiles.

### 3.3 Quality Checks

Two examples of problems are identified in data taken from SCADA or BMI systems on the utility equipment. Figure 3.2 shows the first cases where there is load switching. Load switching is a situation where there are two circuits physically connected at a switch, and those circuits are supplied with power from different transformers. That switch is normally in the open condition, so that electricity does not flow between the circuits. In some scenarios (such as for isolation and maintenance of certain equipment) it is necessary to close the switch and connect the two circuits so that either circuit can take power from the other one’s power source. This provides backup in the event one of the power sources is down.

Figure 3.1 shows a simplified diagram of how this affects the load at the transformer where the two circuits are connected. In this figure, the colors show which transformer is providing the power to serve the customers on the circuit. In Figure 3.1a, the two lines are separated by the normally-open switch in the middle. Customers A, B and C are served by Transformer 1 and Customers D and E are served by Transformer 2 in normal configuration. In Figure 3b, Transformer 1 is disconnected by opening the switch in the

middle, such as in the case when maintenance is being carried out. The other switch is now closed so that Customers A, B, C, D and E are now served by energy delivered through Transformer 2.

The result is that the load measured at Transformer 2 would appear higher than normal during switching configuration, and the moment at which the switching operation occurs would produce an instantaneous jump in load at Transformer 2 shown in Figure 3.2.

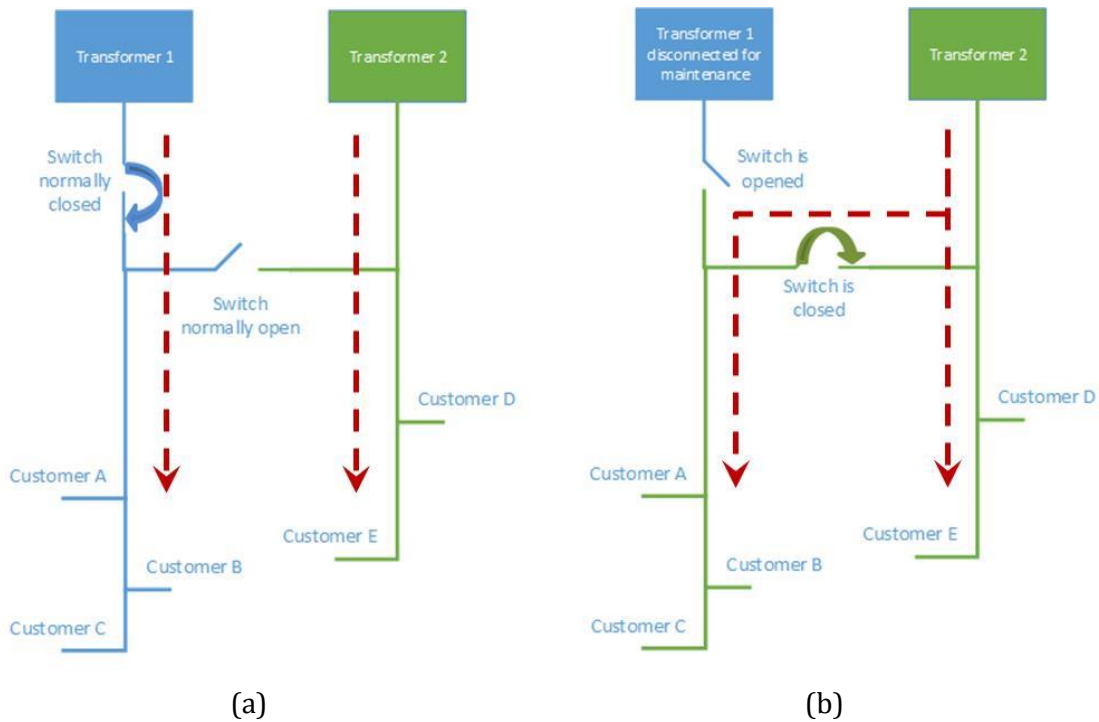

Figure 3.1 Load switching schematic showing a) Normal configuration and b) Switching configuration.

The blue line on Figure 3.2 shows a switching operation is implemented that adds nearly twice the amount load to the feeder from another interconnected feeder for a short time. As this produces an abnormally high load not representative of the the load on the feeder in during normal operations, these switching days are screened and removed from the data.

Figure 3.3 shows the second case where a sensor fails or data loss occurs shown by the sudden drop of demand at 1pm. This is a problem where some feeders may not have available remote monitoring via SCADA or other devices such as BMI, and a method is used to estimate the load profile to complete the analysis. In these cases, if there is load data available for the subtransmission line and part of the connected distribution feeders, the feeders without available load monitoring are allocated the remaining load on the subtransmission feeder. This is not an accurate measurement of the load on these feeders, and results are not reported which are based on this data.

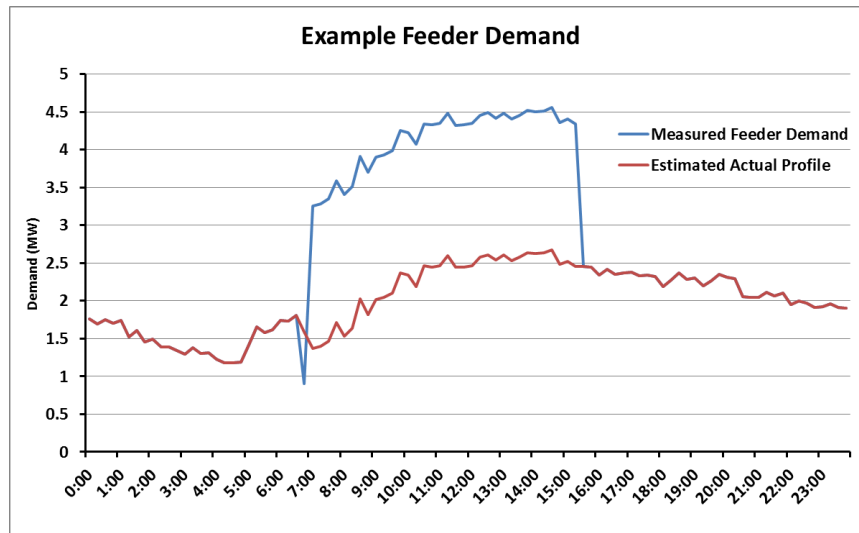

Figure 3.2. Load switching case.

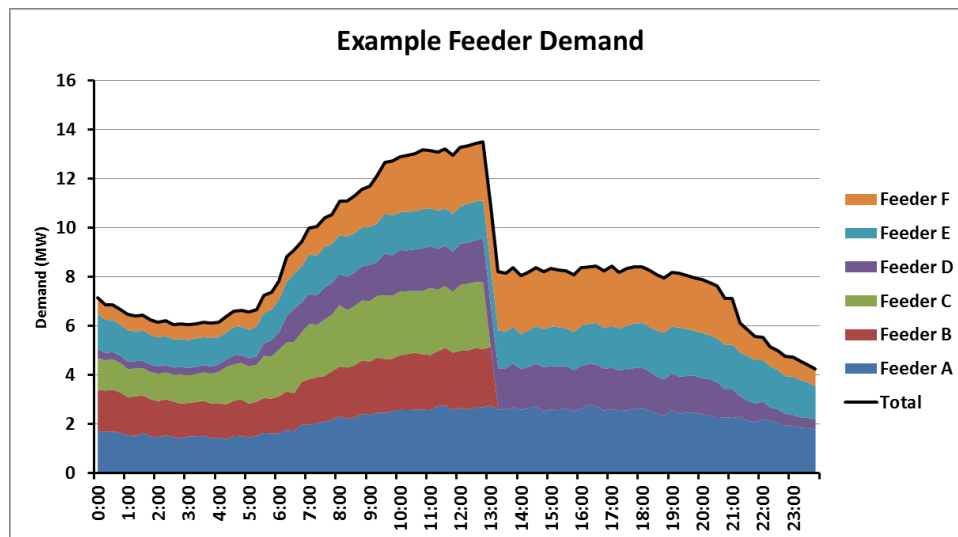

Figure 3.3. Data loss or sensor failure case.

### 3.4 Calculation of Load from Demand

The value measured by utility SCADA and field monitoring equipment is the customer demand measured at the transformer, or at a circuit breaker in the substation. This includes the effect of PV or other generation on the system and does not represent the true “gross” load value. To get from this “net” value to the “gross” load, the approximate PV generation profile is estimated based on sensor data or from irradiance data. The PV generation profile is added to the “net” load profile to get the “gross” load on the system, as shown in the figure below.

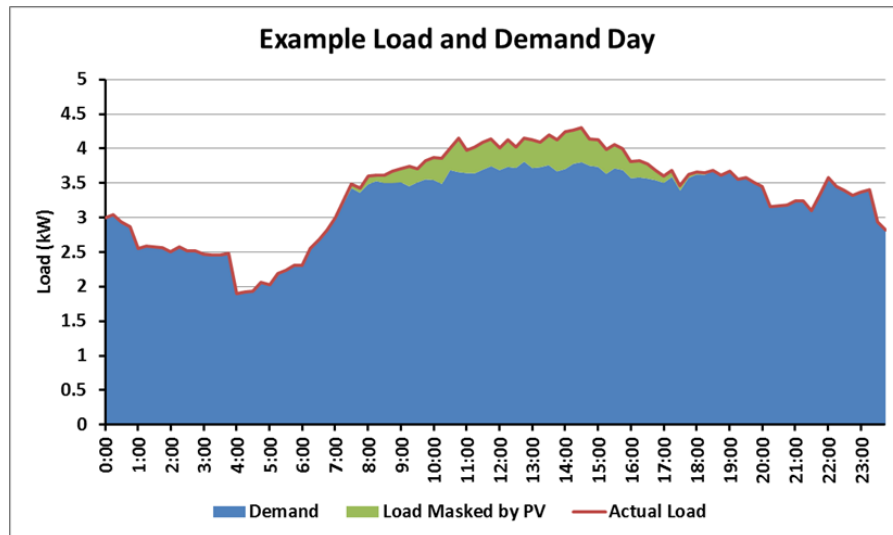

Figure 3.3. Use of the “gross” load profile, rather than the “net” demand profile allows the same load to be used regardless of the PV penetration, resulting in a consistent basis for comparison.

#### 4.0 VALIDATION PROCESS

Data is required to verify the results from the analysis are consistent with actual recorded data. The validation parameters are the voltage and the transformer Load Tap Changer (LTC) position. The LTC is a voltage regulation device on the transformer that ensures the voltage on the secondary side is within a specified range. To check these results, the utility provides a one-day SCADA data profile that includes demand (kW, kVAR and kVA), voltage measured at the transformer, and LTC position, or Basic Measuring Instrument (BMI) data which does not include LTC position.

The input data described in the sections above provides the flexibility to conduct various analyses on PV penetrations. Table 4.1 summarizes the data required for each of the technical criteria and the type of distribution issue (criterion) that can be assessed. Table 4.2 provides an explanation of the criteria and impacts.

Table 4.1 Summary of Data Required for Technical Analysis Criteria.

Criterion	Data Required
<b>Backfeed</b>	Load Data
<b>Line Loading</b>	Load Data, Feeder Model
<b>Voltage</b>	Load Data, Feeder Model, Validation Data
<b>LTC Cycling</b>	Load Data, Validation Data
<b>Fault Current Rise</b>	Feeder Model



Table 4.2 Technical Criteria and Rationale.

Parameter	Limit	Effects and Impacts
<b>Backfeed</b>	Reverse power flow at feeder head	Transformers and protective equipment can respond incorrectly if not set up to recognize and adapt to changes in direction of power flow.
<b>LTC Position</b>	Change in LTC position due to variation in PV output between 100% and 20%	Increased number of cycles on LTC contacts, resulting in reduced service life of contacts and increased maintenance requirements.
<b>Loading</b>	Line loaded over 100% of specified capacity	Equipment would require to be upgraded.
<b>Voltage</b>	Voltage at any point on the distribution system is less than 95% or greater than 105% of nominal.	Customers would experience high or low voltage problems and service may be lost if voltage remains outside nominal $\pm 5\%$ .
<b>Fault Current</b>	Fault current at any point on the distribution system is greater than 105% of that with no PV or 110% of that with no PV	Increases in fault current may require upgrading of protective equipment on the system.

## 5.0 NEXT STEPS

Due to high penetration of distributed resources, the aggregated impact of these resources needs to be accounted for in the planning and operations of the modern grid. No longer is it only a one-way, push of power from central generation to load. This new operating paradigm requires new tools, models and analytical procedures along with appropriate data and field monitoring of the new resources to inform integration and expansion needs. A Proactive Modeling methodology has been developed and is being demonstrated as part of this effort to help standardize and make more transparent the distribution modeling and planning process. Efforts support a more secure and cost effective integration of renewable and DG resources onto grids with high penetrations of variable renewables. A detailed description of the proactive modeling methodology has been provided. The process entails an organizational methodology for diverse distribution networks, recommendations on data type and resolution needed for high penetration PV analysis, recommendations on screening criteria, insights on development of enhanced simulation modeling tools and guidance on model validation process.

Based on Type, Data Categorization, PV penetration levels and other criteria such as incidences, a priority list of clusters by region can be developed to guide ongoing efforts as follow-ons from this task. The next steps in this effort include:

- Application of the criteria to show how circuits are organized for Oahu and prioritized for analysis based on the Data Availability Categorization. Additional details will be provided on the next report. Efforts will describe how the circuit organization and initial data review has helped streamline the data preparation and pre-analysis process. The effectiveness and benefits of categorizing and quantifying the number of feeders into Good-Data, Moderate-Data and Limited-Data bins will also be discussed.
- Conducting the modeling studies and subsequent analysis. Initial studies for this effort will focus on the feeders with Good data and provide summary recommendations on how best to model and prioritize monitoring of remaining categories. Efforts will require gathering of relevant feeder data and in some cases, actual field monitoring to gather sufficient data and creation of visual tools to communicate results.

# Hawaii Grid Cluster Evaluation Project

## Circuit Evaluation and Selection

**HAWAIIAN ELECTRIC COMPANY**

January 8, 2014



Hawaiian Electric  
Maui Electric  
Hawai'i Electric Light

## **Circuit Evaluation and Selection**

### **Task 2, Subtask 2: Report on Recommended Evaluation Criteria and Data Requirements for Selecting Eligible Clusters and Circuits.**

**Submitted to the**

**Hawaii State Energy Office**

**Hawaii Department of Business, Economic Development and Tourism**

**by**

*Contributing Authors*

Hawaiian Electric Company:

Dora Nakafuji,  
Thomas Aukai,  
Amra Brightbill

DNV:

Jonathan Flinn,  
Ronald Davis

**January 2014**

### **Disclaimer**

This report was prepared as an account of work sponsored by an agency of the United States Government. Neither the United States nor any agency thereof, nor any of their employees, makes any warranty, express or implied, or assumes any legal liability or responsibility for the accuracy, completeness, or usefulness of any information, apparatus, product, or process disclosed, or represents that its use would not infringe privately owned rights. Reference herein to any specific commercial product, process, or service by trade name, trademark, manufacturer, or otherwise does not necessarily constitute or imply its endorsement, recommendation, or favoring by the United States Government or any agency thereof. The views and opinions of authors expressed herein do not necessarily state or reflect those of the United States Government or any agency thereof.

### **Acknowledgements**

This material is based upon work supported by the Department of Energy and the State of Hawaii Department of Business, Economic Development and Tourism under award number DE-EE0005354/0005. Efforts build on methodology utility proprietary models and work developed in collaboration with western utility partners under prior grant award from the California Public Utilities Commission's California Solar Initiative (CSI). No utility customer, grid data or business sensitive information is released under this work and all information pertaining to the utilities and proprietary software remain the possession of the utilities.

**Table of Contents**

1.0 INTRODUCTION.....4  
2.0 APPROACH .....4  
3.0 RESULTS – CLUSTER SELECTION .....6  
    3.1 Case 1 – Electrical Cluster A .....7  
    3.2 Case 2 – Electrical Cluster B .....8  
    3.3 Case 3 – Electrical Cluster C .....10  
4.0 BENEFITS.....12  
5.0 NEXT STEPS.....14

## 1.0 INTRODUCTION

This report focuses on the selection of appropriate clusters and associated circuits for project analysis based on the Data Availability Categorization pertaining to the proactive modeling effort. A prior report on the Cluster Evaluation Methodology provided details on the proactive modeling methodology, definitions and description of the cluster/circuit selection process and categorizations. Examples from the Oahu system will be provided showing the consistency of the methodology as applied to feeders with very different load and data characteristics.

The goal of this effort is to demonstrate and apply a comprehensive and systematic Proactive Modeling approach to help streamline and support proactive review of high penetration DG impacts on the island grids.

## 2.0 APPROACH

The Proactive Modeling approach provides a methodology to study the effects of high penetrations of PV on the distribution and subtransmission circuits. The methodology provides a process to build and analyze the study models, which can then be duplicated for all circuits throughout Oahu for an efficient and effective practice that can be shared and utilized for similar studies for the neighbor island grids. Figure 2.1 graphically depicts the full distribution model for the island of Oahu with over 400 distribution feeders. To assess the impacts of all DG on over 400 distribution feeders can be a daunting task and as such, the distribution system has been strategically divided into 12 Regional Clusters as shown in Figure 2.1. Each Regional Cluster is comprised of a number of Electrical Clusters which is defined as a subtransmission feeder down to the distribution substations and associated distribution circuits that are fed from these substations. Each Electrical Cluster has a diverse collection of feeders, loads, distributed generation (DG) and local conditions. For Oahu there are approximately 80 different Electrical Clusters that can be independently assessed for local and individual distribution feeder issues and then later the results can be aggregated to inform transmission level impacts.

An initial data review was performed on all regions and the over 80 electrical clusters based on the initial circuit Typing and Data Availability Screens (Figure 2.2). Based on the review, only a handful of Electrical Clusters had Limited and No Data Categorizations and were prioritized for study. These clusters and circuits that had data limitations are being further prioritized based on PV penetration for monitoring. The majority of the highly impacted distribution feeders had either Good or Moderate Data for purposes of proactive modeling to assess impacts of increasing levels of DG on the feeders. These data screens helped identify and prioritize Electric Clusters with sufficient data to initiate validation checks and modeling runs.

Having Good and Moderate Data does not mean that interconnections of high levels of PV is possible on the feeder, however it does provide greater confidence in using the modeled results to inform decision making and that issues and mitigation measures identified from Hawaiian Electric Company

the study are appropriate. Results of simulation-based models are best used to help inform decision making.

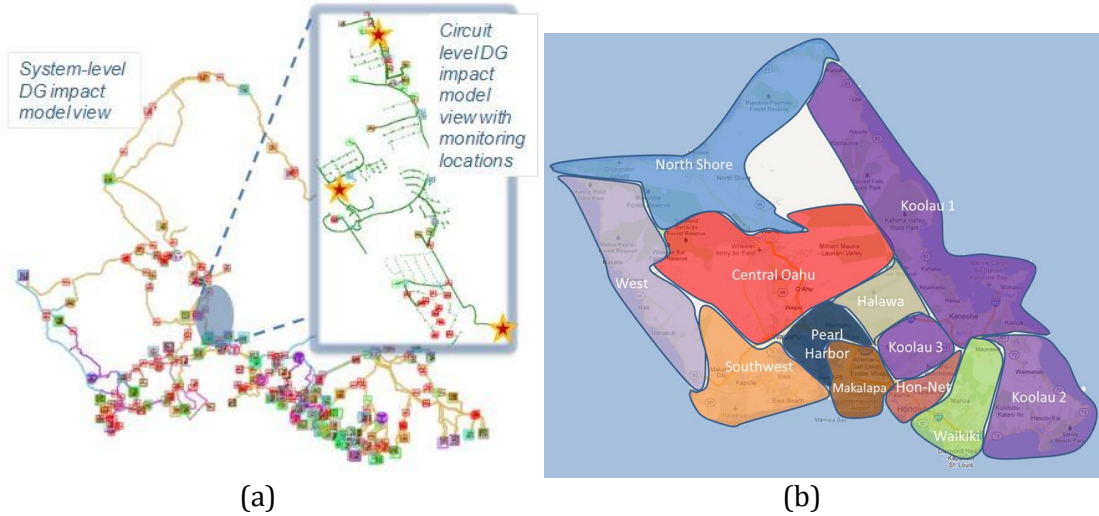

Figure 2.1. a) Distribution network model view and corresponding b) Regional Clusters.

Electrical Cluster (46kV)	Regional Cluster	Model Available	Load Data	Solar Data
Cluster A	Southwest	Yes	Good	Good
Cluster B	Halawa	Yes	Good	Good
Cluster C	West	Yes	Good	Good
Cluster D	North Shore	No	Good	Good
Cluster E	Makalapa	Yes	Good	Limited
Cluster F	Koolau 3	Yes	Good	Limited
Cluster G	Waikiki	Yes	Good	Limited
Cluster H	Pearl Harbor	Yes	Limited	Moderate
Cluster I	Koolau 1	Yes	Moderate	Good
Cluster J	Koolau 2	Yes	No Data	Good
: additional clusters				

Figure 2.2. Excerpt of 46kV Clusters List organized by data priority.



### 3.0 RESULTS – CLUSTER SELECTION

To demonstrate the consistency of the proactive modeling capability, a diverse set of Electrical Clusters from across the island with Circuit Types, Loads and PV installations provided a good format to compare results. Also, for purposes of developing and recommending solutions to mitigate PV impacts to the grid, a common perspective using common data, tools and presentation of results can help support adoption of similar strategies on similar circuits versus investigating every problem as a one-off. The proactive approach was developed to enhance and make the evaluations on distribution circuits more efficient and systematic.

The following three cases and results of the studies are presented to demonstrate the application of a systematic approach and resulting insights. These three cases had available load and solar data as well as complete distribution models and provide a diverse selection of typical residential, commercial, industrial and/or mixed customer types on the feeder. Results of Data Availability checks are presented in similar format for all 3 cases in the sections below.

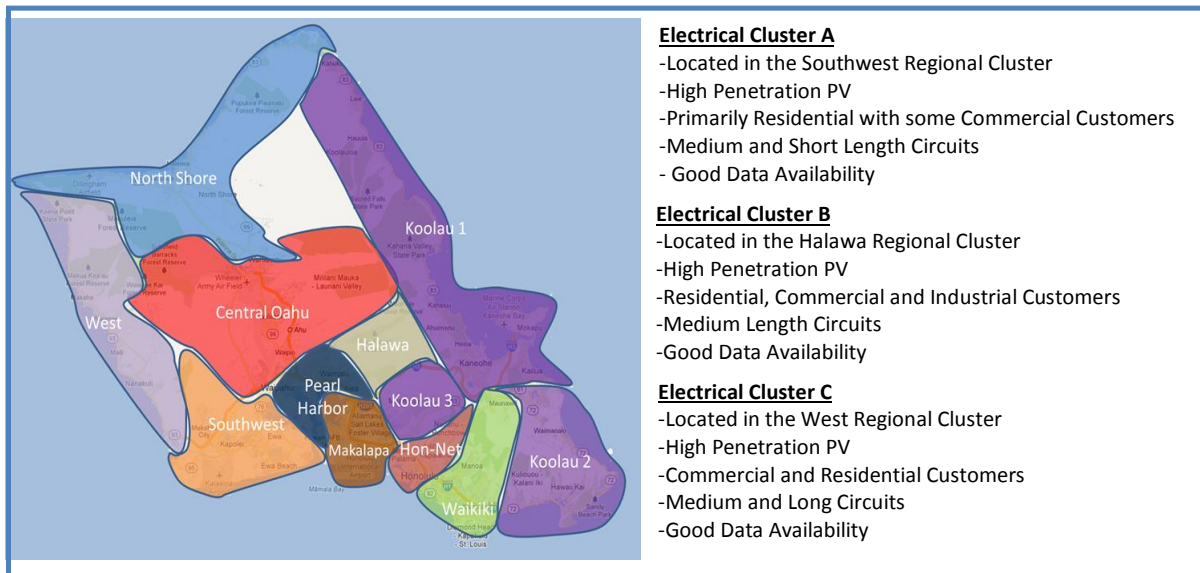

Figure 3.1. Three Electrical Clusters identified for evaluation studies.

Other regions such as North Shore and eastside clusters including Koolua 1, 2, 3 were also prioritized based on the data availability checks and are awaiting studies. For areas that did not pass initial data availability checks, such as solar data or feeder data, they are being evaluated for monitoring and are being prioritized.

### 3.1 Case 1 – Electrical Cluster A

Cluster A is located in the Southwest Regional Cluster, and is comprised of a single 46kV subtransmission feeder and seven 12kV distribution circuits. Figure 3.2 shows a geographic layout of the feeders in Cluster A. Table 3.1 lists the existing PV installed and PV penetration levels for each of the distribution circuits.

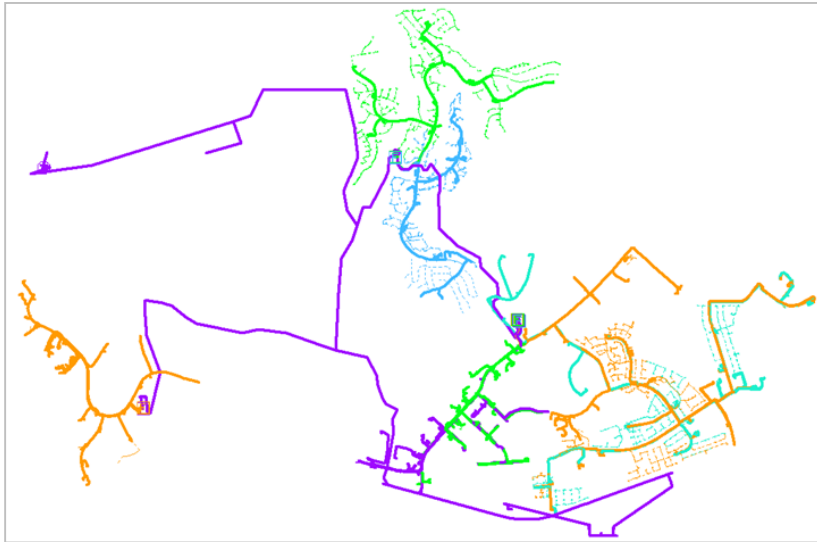

Figure 3.2. Geographic layout of Electrical Cluster A.

Table 3.1. Summary of Case 1 – Electrical Cluster A attributes including number of distribution circuits and installed PV and PV penetration levels.

Feeder	Existing PV (kW)	Penetration based on DML of Existing PV (% Range)
Circuit A.1	710	15 - 50%
Circuit A.2	581	75 - 100%
Circuit A.3	198	15 - 50%
Circuit A.4	718	Greater than 100%
Circuit A.5	0	0 - 15%
Circuit A.6	426	15 - 50%
Circuit A.7	909	50 - 75%

Data Availability Check	Results
<b>PV Penetration and Type</b>	<p>PV penetration levels for the distribution circuits listed above represent a high level of PV installed, and serve as a good study baseline to compare study analyses to measured data in confirming results.</p> <p>Almost all the distributed generation on these circuits is coming from rooftop NEM PV installations. This electrical cluster represents a more evenly distribution of PV along the distribution feeders compared to distribution circuits where there are fewer but larger PV installations along the distribution feeders.</p>
<b>Circuit Type</b>	<p>These distribution circuits predominantly serve residential customers. The Electrical Cluster is then defined as residential with some commercial.</p>
<b>Circuit Length</b>	<p>The distribution circuits are mainly residential and serve neighborhoods in the vicinity of the distribution substation. The distribution feeders include both short and medium lengths and will be good to study voltage issues along the feeder and close to the source (distribution substation).</p>
<b>Data Availability</b>	<p>Available data for this electrical cluster is good both for load data and solar resource data, allowing easy validation of baseline study results in order to develop PV growth scenarios.</p>

### 3.2 Case 2 – Electrical Cluster B

Cluster B is located in the Halawa Regional Cluster, and is comprised of a single 46kV subtransmission feeder and eight 12kV distribution circuits. Figure 3.3 shows a geographic layout of the feeders in Cluster B. Table 3.2 lists the existing PV installed and PV penetration ranges for each of the distribution circuits.



Figure 3.3. Geographic layout of Electrical Cluster B.

Table 3.2. Summary of Case 2 – Electrical Cluster B attributes including number of distribution circuits and installed PV and PV penetration levels.

Feeder	Existing PV (kW)	Existing PV (% of Min Load)
Circuit B.1	312	15 - 50%
Circuit B.2	1245	75 - 100%
Circuit B.3	128	0 - 15%
Circuit B.4	0.0	0 - 15%
Circuit B.5	51	0 - 15%
Circuit B.6	844	75 - 100%
Circuit B.7	362	Greater than 100%
Circuit B.8	289	75 - 100%

Data Availability Check	Results
<b>PV Penetration and Type</b>	<p>PV penetration levels for the distribution circuits listed above represent a high level of PV installed, and serve as a good study baseline to compare study analyses to measured data in confirming results.</p> <p>The distributed generation on these circuits is coming from rooftop NEM PV installations and commercial SIA installations, with some FIT systems installed to sell power</p>

	directly to the utility. This electrical cluster represents a diverse mix of distributed generation (PV). With more site specific locations of larger PV systems installed on the distribution feeders, the analysis may show hot spots for voltage concerns compared to electrical cluster A with the more evenly distributed placements of smaller PV systems.
<b>Circuit Type</b>	These distribution circuits serve a mix of residential, commercial and industrial customers. The Electrical Cluster is then defined as residential, commercial and industrial.
<b>Circuit Length</b>	The distribution circuits serve a local location of residential, commercial and industrial customers. The distribution feeders include both short and medium lengths and will be good to study voltage issues along the feeder and close to the source (distribution substation).
<b>Data Availability</b>	Available data for this electrical cluster is good both for load data and solar resource data, allowing easy validation of baseline study results in order to develop PV growth scenarios.

### 3.3 Case 3 – Electrical Cluster C

Cluster C is located in the West Regional Cluster, and is comprised of a single 46kV subtransmission feeder and five 12kV distribution circuits. Figure 3.4 shows a geographic layout of the feeders in Cluster C. Table 3.3 lists the existing PV installed and PV penetration levels for each of the distribution circuits.



Figure 3.4. Geographic layout of Electrical Cluster C

Table 3.3. Summary of Case 3 – Electrical Cluster C attributes including number of distribution circuits and installed PV and PV penetration levels.

Feeder	Existing PV (kW)	Existing PV (% of Min Load)
Circuit C.1	671	15 - 50%
Circuit C.2	358	15 - 50%
Circuit C.3	494	15 - 50%
Circuit C.4	471	15 - 50%
Circuit C.5	1052	15 - 50%

Data Availability Check	Results
<b>PV Penetration and Type</b>	<p>PV penetration levels for the distribution circuits listed above represent a medium level of PV installed, and serve as a good study baseline to compare study analyses to measured data in confirming results. Though, the current condition represents a medium level of PV, growth forecasted for this region is significant with the queue of projects consisting of large FIT projects. These future FIT projects will be included when studying future PV scenarios.</p> <p>The distributed generation on these circuits is coming from rooftop NEM PV installations and commercial SIA installations, with some FIT systems installed and a significant amount of FIT queued for future construction. This electrical cluster represents a diverse mix of distributed generation (PV), and is a mix between electrical clusters A and B. Electrical cluster C currently consists of a PV scenario similar to electrical cluster A, with future growth to resemble a larger scenario of electrical cluster B.</p>
<b>Circuit Type</b>	<p>These distribution circuits serve a mix of commercial and residential customers. The Electrical Cluster is then defined as commercial and residential.</p>
<b>Circuit Length</b>	<p>The distribution circuits serve a coastal region of commercial and residential customers. The distribution feeders include both short, medium long lengths and will be good to study voltage issues along the feeder and close to the source (distribution substation) as well as voltage issues at the end of long feeders.</p>
<b>Data Availability</b>	<p>Available data for this electrical cluster is good both for load data and solar resource data, allowing easy validation</p>

of baseline study results in order to develop PV growth scenarios.

## 4.0 BENEFITS

A proactive modeling methodology was developed and improved upon with past high penetration PV studies to use as a template for current and future work. The current process for data screening has become an efficient process to identify and choose areas for analyses, prepare required data for validation efforts and report study results and solutions in a template form for consistency and ease of use.

The Data Availability Screening used to identify and prioritize the electrical clusters on Oahu uses 4 primary criteria:

1. PV Penetration and Type of Installations
2. Circuit Type (Residential, Commercial, Industrial)
3. Circuit Length
4. Data Availability (Solar Irradiance Data and Load Data)

These four criteria are based on past high penetration PV studies and the requirements identified to successfully develop the planning models for the study areas. Tools were also developed to capture these criteria and the underlying data used to prioritize the clusters, as well as automate some of the data collection tasks to understand the quality and availability of data for a regional cluster.

Each criterion is explained in further detail pertaining to the three electrical clusters of this study in the following sections.

### PV Penetration and Type of Installations

Identifying the PV penetration levels and types of PV installations helps to define how the PV is distributed on the circuit and where future PV growth is available. PV installed on residential rooftops (NEM) are smaller systems and are more evenly distributed along a distribution feeder versus the larger SIA and FIT systems that have the ability to inject high levels of generation on the distribution feeder at specific points of interconnection. From the Data Availability Screen, three very different clusters with categories of feeder types (residential, commercial, mixed) were selected for initial study to provide insight on how different types of PV installations (e.g. FIT, SIA, NEM) would impact the region. Studies drew from a list of currently queued projects for impact analysis and did not presume any specifics of technology or status on the projects.

Electrical Cluster A is primarily populated with residential rooftop PV (NEM), and will identify issues related to this specific type of scenario. Most of the PV installed and predicted for growth on Oahu is in the form of NEM installations, and the results of this study case will benefit future studies of similar electrical clusters.

Electrical Cluster B is comprised of a diverse makeup of PV installations, including all three types with NEM, SIA and FIT systems installed throughout the cluster area. This scenario will provide a study platform to understand the aggregate effects of small and large PV systems.

This is an opportunity to determine how the larger PV systems during periods of generating electricity directly onto the grid will affect the local residential loads and circuit infrastructure used to monitor and manage circuit reliability. And, in turn to study how the larger customer grid interconnection points respond to the intermittency of distributed PV as a result to passing clouds.

Electrical Cluster C is an interesting case because the future PV growth of this area is substantial in the form of large FIT projects. The current PV scenario is still in the moderate penetration levels, allowing the study to take place and capture results before the circuits are saturated with the FIT projects.

With the FIT projects eventually installed and feeding electricity directly onto the grid, another study case can be conducted to validate the study models and fine tune as needed for use with other similar scenarios. Studying an electrical cluster before and after high penetration levels will be beneficial in capturing and validating circuit occurrences due to high levels of PV. Electrical Cluster C is an extreme case of this condition.

#### Circuit Type

Identifying the circuit types of potential study areas also provides insight to future PV growth scenarios. Large commercial sites can be potential SIA and FIT locations, whereas residential areas will be available mainly to NEM installations.

The bookends of high penetration PV studies are the residential circuit type and commercial/industrial circuit type. Understanding these bookend conditions will develop the envelope for possible solutions, which should also cover scenarios consisting of a combination of circuit types.

Electrical Cluster A will mainly be open for NEM installations due to the high density of residential homes. Although there are other highly residential circuits, this area is well represented in terms of available load and solar data, as well as having very little commercial PV installations, which is great for studying the residential bookend described above.



Electrical Cluster B represents a scenario in the middle of the extremes, with a diverse mix of circuit types consisting of residential, commercial and industrial customers. This cluster study may identify circuit conditions not captured by the other two study clusters, as well as validate the solutions for the bookend conditions and/or identify unique solutions for diverse clusters.

Electrical Cluster C represents a commercial and residential scenario. As stated earlier, this cluster is a unique case to understand the before and after conditions of large FIT installations, and will represent a platform to investigate specific solutions to this combination of circuit types.

#### Circuit Length

All three Electrical Clusters (A, B, C) are similar with regards to circuit lengths, with Electrical Cluster C consisting of some longer feeders (generally more than 2 miles). Shorter feeder lengths will not experience as much voltage issues seen on longer feeders, so for this study it was a priority to choose circuits consisting more of the medium to upper lengths with some short feeders for comparison.

#### Data Availability

Data availability is the most determining factor for prioritizing the electrical clusters for study. Circuit and solar data allows the developed models to be validated and used to build future scenarios. If the models are incapable of being validated, the results of the study are useful only in a generic sense of a broad understanding of PV impacts and not specific to the circuits being studied.

All three electrical clusters in this study have both load and solar data which allow the models to be validated. Data sources for these clusters come in the following forms:

- Substation load data measured at the transformers and circuit breakers feeding the distribution feeders
- Solar Irradiance data from solar irradiance kits installed at the substations, area schools, and private lots in the surrounding areas
- Solar resource monitors installed at the substations

Load monitors can also be installed at customer vaults of interest, mainly large commercial or industrial sites, but due to the good amount of load data available for all three electrical clusters this data collection method was not deployed.

## **5.0 NEXT STEPS**

This report captures the results of the Data Availability review and Circuit Selection process. Based on Type, Data Categorization, PV penetration levels and other criteria such as incidences, all circuits and clusters were reviewed. A prioritized list of good and

moderate data clusters can be reasonably studied and a recommended list of feeders for further monitoring was also produced.

Remaining steps are to initiate modeling studies and subsequent analysis using the SynerGEE model for the distribution level analysis and based on current progress, time-dependent analysis using the transmission models (PSS/E) can also be conducted. The results of both models will hopefully provide insight on development of more common mitigation strategies. Plans are to conduct runs based on the three Electric Clusters described in this report and submitted as a follow-up Results Report..

# Hawaii Grid Cluster Evaluation Project

Draft Cluster/Circuit Analysis Results

**HAWAIIAN ELECTRIC COMPANY**

April 2014



Hawaiian Electric  
Maui Electric  
Hawai'i Electric Light

## **Draft Proactive Analysis Results**

### **Task 3: Preliminary Report on Cluster/Circuit Analysis Results**

**Submitted to the**

**Hawaii State Energy Office**

**Hawaii Department of Business, Economic Development, and Tourism**

**by**

*Contributing Authors*

Hawaiian Electric Company:

Dora Nakafuji  
Thomas Aukai,  
Amra Brightbill

DNV:

Jonathan Flinn,  
Ronald Davis

**April 2014**

### **Disclaimer**

This report was prepared as an account of work sponsored by an agency of the United States Government. Neither the United States nor any agency thereof, nor any of their employees, makes any warranty, express or implied, or assumes any legal liability or responsibility for the accuracy, completeness, or usefulness of any information, apparatus, product, or process disclosed, or represents that its use would not infringe privately owned rights. Reference herein to any specific commercial product, process, or service by trade name, trademark, manufacturer, or otherwise does not necessarily constitute or imply its endorsement, recommendation, or favoring by the United States Government or any agency thereof. The views and opinions of authors expressed herein do not necessarily state or reflect those of the United States Government or any agency thereof.

### **Acknowledgements**

This material is based upon work supported by the Department of Energy and the State of Hawaii Department of Business, Economic Development, and Tourism under award number DE-EE0005354/0005. Efforts build on methodology utility proprietary models and work developed in collaboration with western utility partners under prior grant award from the California Public Utilities Commission's California Solar Initiative (CSI). No utility customer, grid data or business sensitive information is released under this work and all information pertaining to the utilities and proprietary software remain the possession of the utilities.

**TABLE OF CONTENTS**

**1.0 INTRODUCTION .....4**

**2.0 APPROACH .....8**

2.1 MODELS AND DESCRIPTIONS ..... 8

2.1.1 *Types of Simulation Models*..... 8

2.1.2 *Physical Model and Cluster Descriptions* ..... 9

2.2 EVALUATION CRITERIA AND ANALYSIS SCENARIOS..... 14

2.2.1 *Load Profiles*..... 14

2.2.2 *Technical Criteria for Evaluation* ..... 17

2.2.3 *Range of PV Penetrations & Scenarios* ..... 19

2.4 MODEL ASSUMPTIONS AND INPUT DATA REQUIREMENTS..... 23

2.4.1 *Minimum and Peak Daytime Load Profiles*..... 24

2.4.2 *Validation Data and Process* ..... 26

**3.0 RESULTS – STEADY STATE.....26**

3.1 ELECTRICAL CLUSTER A EVALUATION RESULTS ..... 27

3.1.1 *Electrical Cluster A Load Profiles* ..... 28

3.1.2 *Electrical Cluster A Validation* ..... 29

3.1.3 *Electrical Cluster A Results*..... 31

3.1.4 *Electrical Cluster A Summary*..... 35

3.2 ELECTRICAL CLUSTER B EVALUATION RESULTS..... 36

3.2.1 *Electrical Cluster B Load Profiles*..... 37

3.2.2 *Electrical Cluster B Validation*..... 38

3.2.3 *Electrical Cluster B Results*..... 39

3.2.4 *Electrical Cluster B Summary*..... 42

3.3 ELECTRICAL CLUSTER C EVALUATION RESULTS..... 42

3.3.1 *Electrical Cluster C Load Profiles*..... 43

3.3.2 *Electrical Cluster C Validation*..... 44

3.3.3 *Electrical Cluster C Results*..... 46

3.3.4 *Electrical Cluster C Summary*..... 49

3.4 APPLYING RESULTS TO QUANTIFY REMAINING CAPACITY ON FEEDERS ..... 50

**4.0 RESULTS – DYNAMIC ANALYSIS OF GENERATOR TRIP EVENT .....52**

4.1 ANALYSIS PROCESS ..... 53

4.2 INPUT DATA ..... 55

4.3 ANALYSIS PROCESS ..... 56

4.4 RESULTS AND ANALYSIS ..... 57

4.5 SUMMARY OF DYNAMIC CASE..... 59

**5.0 MITIGATION MEASURES .....59**

**6.0 SUMMARY & RECOMMENDATIONS.....65**

6.1 FEEDER RESULTS AND STREAMLINING BENEFITS..... 66

6.2 NEXT STEPS..... 67

**7.0 REFERENCES .....69**

## 1.0 INTRODUCTION

To adequately assess and stay ahead of high-PV penetration concerns on distribution feeders, the Proactive Approach has been developed to enhance planning models and incorporate inverter based information and distributed PV generators within the utility's baseline modeling and planning practice. A prescribed model validation process has also been introduced and described in prior reports [1, 2] for this effort to streamline the data gathering, model build, model validation and reporting process in support of studies including Interconnection Reliability Study (IRS) needs. While the Proactive Approach does not replace the IRS, through the Proactive Approach Methodology, a more transparent and consistent scenario-based analysis and reporting capability is available to help improve high penetration impact analysis for the electrical system and interconnection evaluations. Model, data and prioritization of feeder impacts form fundamental components of the Proactive Approach to conduct cluster evaluations for groups of feeders instead of the traditional one project at a time or one feeder at a time analysis and to be able to consistently "roll-up" distribution level impacts up to the system level. One of the biggest changes to traditional modeling introduced as part of Proactive Approach is modeling distribution resources as generators versus negative load. This enables future smarter functionality to be incorporated to help manage variability due to renewables; however, it also helps improve system reliability and provides cost savings by accounting for behind the meter generation. Hawaiian Electric Companies have enabled a REWatch capability to "see" behind the meter generation, and with a proactive modeling capability, can begin to more timely and effectively "manage" the higher penetrations of variable behind the meter generation.

The cluster evaluations conducted as part of a proactive modeling effort can be performed in anticipation of growth or new development and assess conditions and impacts. Results can be used to inform limits or other impacts that may need further analysis which are typically investigated as part of project IRS or more detailed design studies. To support the level of change resulting from high penetrations of distributed resources on the grid requires the following

- Enhanced modeling tools,
- Consistent screening and evaluation procedures,
- Common queue to prioritize studies, and
- Analysis capability to factor in new resource information and handle the increased volume of customer demand in a timely basis.

As part of grant funded initiatives, Hawaiian Electric Companies developed the Proactive Approach in partnership with western utilities and industry to establish a consistent process using enhanced modeling tools and transparent procedures for conducting high penetrations evaluations and respond to the growing need.

As part of the Renewable Standards Working Group (RSWG), established by the Hawaii Public Utilities Commission to assess recent changes and growth of renewables on the Hawaiian grids, the Proactive Modeling concept was unanimously recommended by the RSWG PV Subgroup for

Hawaiian Electric Company

Task 3 Deliverable – Draft Cluster/Circuit Analysis Results

adoption as a viable pathway forward for utilities and the solar industry to develop proactive planning practices and address DG impacts on the grid. Incorporating the process enables the ability to get a “heads up” on distributed generation conditions and when the conditions can impact transmission and system level operations.

Maintaining updated baseline simulation models and routinely conducting analysis will enable utilities to track changes and assess mitigation strategies in a timely fashion across the overall electric system instead of one project or circuit at a time. The modeling techniques and lessons learned from the Hawaii Proactive Approach are applicable to all utilities contending with challenges (planning, operating & mitigating) of future high penetration issues related to DG.

The objectives of the Proactive Studies include:

- Applying the cluster-based model organization and new variable resource data requirements for conducting high penetration analysis on distribution and transmission systems
- Identifying levels of PV penetration at which specific problems begin to occur for the distribution system;
- Using simulations to quantify remaining capacity in kW on existing distribution infrastructure and provide perspective on the potential of additional PV installations;
- Informing system impacts due to distributed PV through both steady-state and dynamic modeling analysis; and
- Evaluating and recommending mitigation options based on model evaluations.

This report focuses on real-world application of the methodology with simulation results for three Electrical Clusters: Electrical Cluster A – the Southwest region, Electrical Cluster B – Halawa region, and Electrical Cluster C – the West region, as shown in Figure 1.1. Each Electrical Cluster is comprised of interconnected substations (46kV to 12kV level) and associated 12kV distribution circuits. Results presented highlight 3 out of 12 Geographic Regions on Oahu.

These circuits were chosen because of the high penetration of PV, availability of utility data on majority of the circuits in the cluster for validation purposes and also based on the diversity of the types of customer loads on these circuits. These Electrical Clusters provide a good demonstration of the applicability of the Proactive Approach for different infrastructure conditions (i.e. types of customer loads, length of lines, data availability). As there are over 50 Electrical Clusters across the island of Oahu, a Data Verification Process was introduced as part of the Proactive Methodology, as described in Task 2.1 and Task 2.2 reports, to prioritize the clusters for analysis based on the completeness of data (Figure 1.2). At minimum, an appropriate simulation model, measured customer load information (e.g., residential, commercial, industrial) on circuits and field monitored solar data local to the area, constitute “Good” data suitable for Electrical Cluster analysis. Areas that lacked one or many of the data are placed lower on the list and identified for further field monitoring and modeling at a later time when data is available.



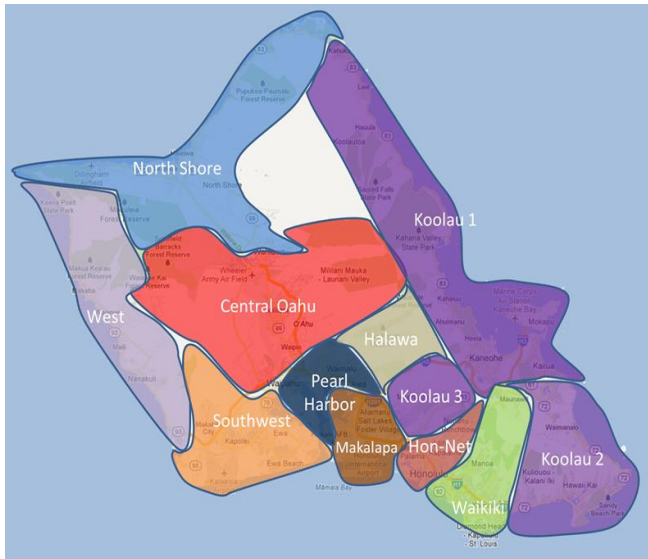

**Electrical Cluster A**

- Located in the Southwest Regional Cluster
- High Penetration PV
- Primarily Residential, some Commercial Customers
- Medium and Short Length Circuits
- Good Data Availability

**Electrical Cluster B**

- Located in the Halawa Regional Cluster
- High Penetration PV
- Residential, Commercial and Industrial Customers
- Medium Length Circuits
- Good Data Availability

**Electrical Cluster C**

- Located in the West Regional Cluster
- High Penetration PV
- Commercial and Residential Customers
- Medium and Long Circuits
- Good Data Availability

Figure 1.1 Three Electrical Clusters identified for Proactive Evaluation studies.

Electrical Cluster (46kV)	Regional Cluster	Model Available	Load Data	Solar Data
Cluster A	Southwest	Yes	Good	Good
Cluster B	Halawa	Yes	Good	Good
Cluster C	West	Yes	Good	Good
Cluster D	North Shore	No	Good	Good
Cluster E	Makalapa	Yes	Good	Limited
Cluster F	Koolau 3	Yes	Good	Limited
Cluster G	Waikiki	Yes	Good	Limited
Cluster H	Pearl Harbor	Yes	Limited	Moderate
Cluster I	Koolau 1	Yes	Moderate	Good
Cluster J	Koolau 2	Yes	No Data	Good

Figure 1.2 Excerpt of Electrical Clusters List organized by data priority.

The three Electrical Clusters highlighted in this report demonstrate varying levels of “Good” data. They will be used to show how the Proactive Analysis can provide early detection of critical

thresholds or impacts resulting from increasing penetrations of PV on the circuit, at the cluster level and even at the system level.

With consistent data and models, the Proactive Approach can progressively build on prior studies as new data becomes available to assess impacts and consider mitigations to address emergent needs. Completed Cluster studies can thus be used to provide proxy information or be used to inform conditions on similar circuits that currently have limited or no data.

This report documents the application of the Proactive Modeling process and showcases how simulations results can be used to track impacts and inform where monitoring and mitigation for high penetration PV is needed. Section 2.0 provides a detailed description of the overall approach in conducting the analysis and stepping through the analysis. High penetrations of distributed PV pose new requirements for traditional distribution modeling. As such, modeling enhancements, new data and analysis considerations are discussed including background on steady-state and dynamic analysis scenarios, description of the clustering approach to organize the grid, new data and validation requirements, technical criteria and assumptions and analysis process. These details are presented to give readers a glimpse into some of the considerations for running simulation models. Section 3.0 and Section 4.0 focus on the steady-state and dynamic results, respectively. Results are presented for the different cluster cases and scenarios. Results are also explained based on a set of high penetration evaluation criteria (both steady-state and dynamic) used to assess different grid conditions and recommend change given changing penetration levels. Insight on remaining capacity for the 4 clusters is also provided. Results for the 3 cluster evaluated provide one of the first attempts to quantify remaining capacity on the feeder and the associated criteria. Section 5.0 provides a discussion on different mitigation options, their pros and cons and considerations as applicable to conditions analyzed. While some mitigation recommendations are more near-term, such as monitoring needs, others require additional review and are provided as consideration options. Section 6.0 summarizes Benefits, Recommendations and Next Steps. The report also provides some recommendations on using the Proactive Approach as part of a routine process and using the results to conduct additional cost-benefit evaluations to consider alternative economic mechanisms and define strategies for integrating renewables. Section 7.0 provides other reference material related to the Proactive Approach to conduct high penetration analysis.

As utilities, Hawaiian Electric Companies are one of the utilities contending with some of the highest levels of distributed PV penetration and are actively working with other utilities like the Sacramento Municipal Utility District, and with support from industry, state and federal resources, to devise ways to assess and address change and enable cost-effective transformation strategies for electric customers. The Proactive Approach does not solve all the issues but hopefully it can provide the beginnings of a consistent framework and systemic process to organize data, prioritize through establishing thresholds, perform evaluations with appropriate models and communicate findings to inform decision-making.

## 2.0 APPROACH

The following sections describe what types of simulation models are used, what data inputs are needed, how the data is used in the analysis, how the model is validated, what data assumptions are made, which evaluation criteria are of concern, and how results can be used to inform decisions. As model simulation analyses are conducted, the results are processed for each distribution circuit to identify the technical conditions or criteria exceeded and at what level of PV penetration.

Depending on the evaluation criteria, level of exceedance and existing infrastructure limitations, the results will provide guidance on distributed PV impacts on the system due to existing levels of distributed generation and shed insight on the future potential levels of distributed generation and mitigations.

By providing results for different thresholds or “hot spots” based on the analysis, the hope is that the value and benefit of future upgrades, mitigations or new distributed PV installations can be cost-effectively weighed.

### 2.1 Models and Descriptions

Standard industry electrical load flow modeling tools are used to conduct the high-penetration PV modeling analyses for the 3 Electrical Clusters. The models simulate how electricity flows through a circuit. As such, these models need certain input data containing detailed information on the existing utility infrastructure, including setting and limits. On the island of Oahu, the utility models contain information on the generators, the transmission infrastructure (138kV to 46kV level) and the distribution system (46kV to 12kV nominal levels and down to residential line voltages).

Utilities maintain *baseline reference models and proprietary database* information representative of their service territory including generators, infrastructure (i.e., transmission, distribution, protection) and loading characteristics of their customers. These models are typically maintained and used by the utility planning departments.

#### 2.1.1 Types of Simulation Models

Simulation-based models are used to design and assess the system or any part of the network under different steady and time variant conditions, as introduced by those running the model(s). System network stability is one of the most important criteria for maintaining reliability and represents how stable the system will remain due to changes or disturbances. Models are used to represent the system’s response under steady-state and dynamic (time transient) conditions. The following are two types of simulations used in this analysis:

1. Steady state simulations capture the system equilibrium conditions or how stable the system is in response to small and slow changes. Most component design specifications are listed for steady-state operations. Steady state simulations thus look to model the output of PV systems on 1) a clear sunny day compared to 2) a cloudy day condition.
2. Dynamic analysis looks at time-variant and continuous change due to load or generation in normal and non-normal (contingency) conditions. Dynamic studies capture detailed change response over a period of time for the system ranging from faults (transients), recovery to normal conditions. For high penetration PV systems, dynamic simulations are useful to assess system response due to voltage, current and frequency change in transient

conditions (sub-seconds to seconds) or to ramp conditions lasting minutes to hours. Thus dynamic analysis is often the most data and model intensive. As such dynamic modeling requires very accurate model representations and validation data from the actual infrastructure including details such as relays, inverters, line impedances, switching, measured solar conditions and geographic locations.

- Transient simulations are a subset of dynamic analysis that looks at transitory or very short, time-variant change events such as a fault (i.e. line or generator). Transient stability studies for example, assess how quickly the system returns to stable conditions after a sudden fault or change over a prescribed time interval (ranging from sub-seconds to tens of seconds).

For the Proactive Analysis, the SynerGEE distribution model (for steady-state analyses) and PSS/E transmission model (for transient and dynamic analyses) are used to conduct simulations [3, 4]. Both the SynerGEE and PSS/E models are widely used, commercially available load flow models supported by software developers, DNV GL and Siemens, respectively. These models were chosen as they are being used by Hawaiian Electric Distribution and Transmission Planning staff and consultants for conducting distribution and transmission, steady-state and dynamic analysis. Both models have recently been enhanced, as part of the California Solar Initiative (CSI) and in partnership with DNV GL, to integrate distributed PV as generators versus simply as load reducers. Other dynamic simulation models such as PSCAD and CYME have also been used for specific transient studies at the distribution level, however the baseline reference models and validation data come from SynerGEE.

### 2.1.2 Physical Model and Cluster Descriptions

The Feeder Model provides a geographical layout of the distribution system, the equipment specifications and the connected loads on the distribution circuits. With high PV penetrations, the feeder models have also been enhanced to include individual residential roof-top distributed PV systems (Figure 2.1). The completed distribution feeder models and associated databases (one for distribution models and one for transmission model) are maintained by the utility within proprietary GIS mapping applications.

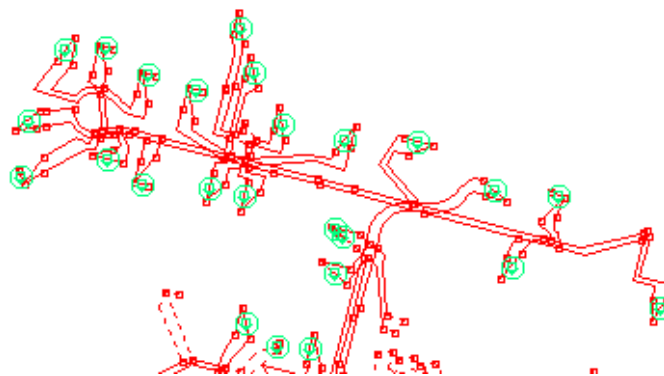

Figure 2.1. Detailed Feeder Model representation of a single distribution circuit and associated distributed roof-top PV systems shown in green.

As studies are conducted, areas of focus can be extracted for use in analysis models as illustrated in Figure 2.2. Studies are conducted using appropriate extracts of the associated sub-transmission and distribution feeders required for each study primarily to improve efficiencies and reduce the time it takes to run the full models.

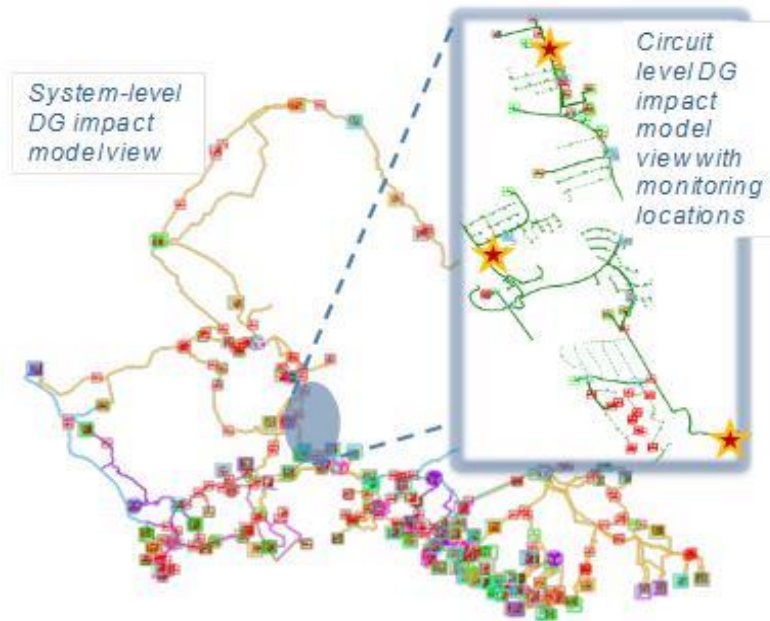

Figure 2.2. Graphical representation of the complete utility-owned distribution system and an extract of a cluster study area in callout box.

Figures 2.3 through 2.8 graphically depict the three Electrical Clusters for this study with and without PV. Within each electrical cluster are numerous individual circuits also included in this analyses. Existing Generators represent currently connected PV and Additional Generators represent a queued list of PV applicants and future potential. The future potential is a modeling variable used to increase PV levels on circuits and conduct “what-if” scenarios.

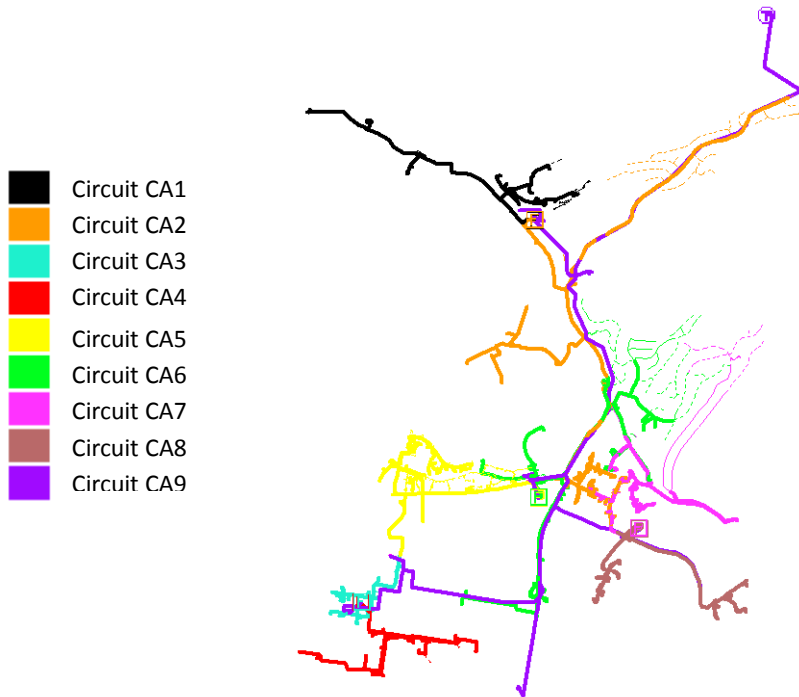

Figure 2.3. Cluster A Feeder Map.

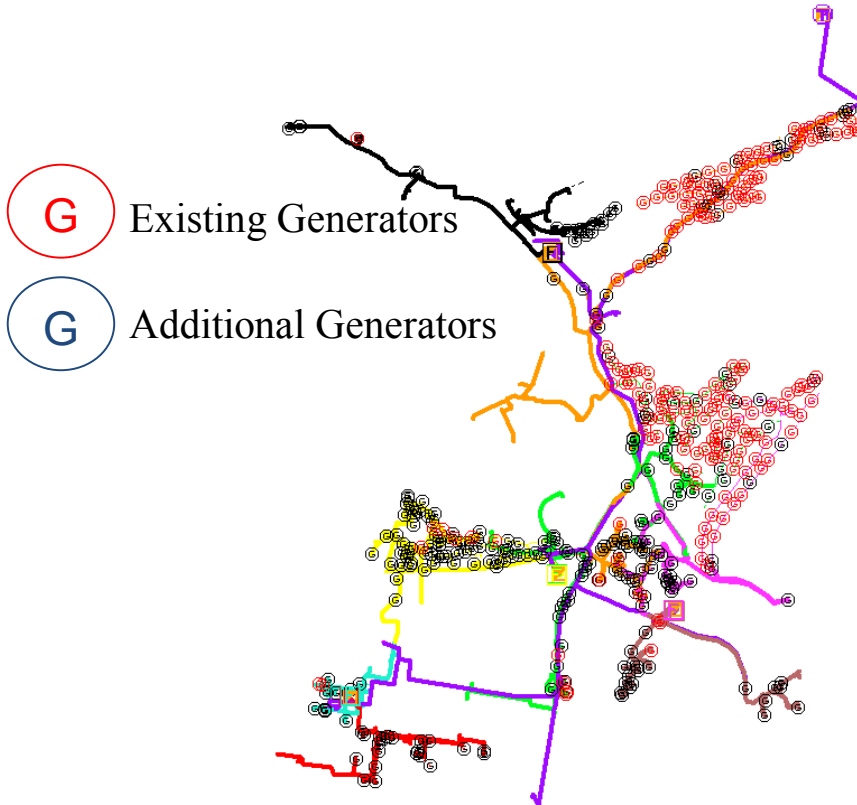

Figure 2.4. Cluster A PV Locations.

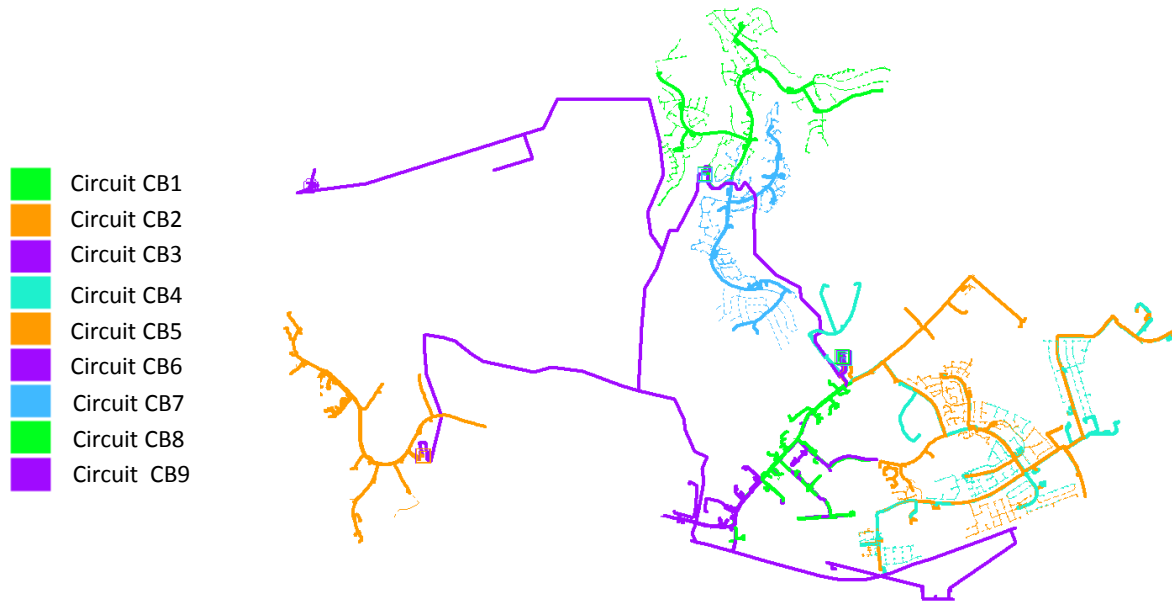

Figure 2.5. Cluster B Feeder Map.

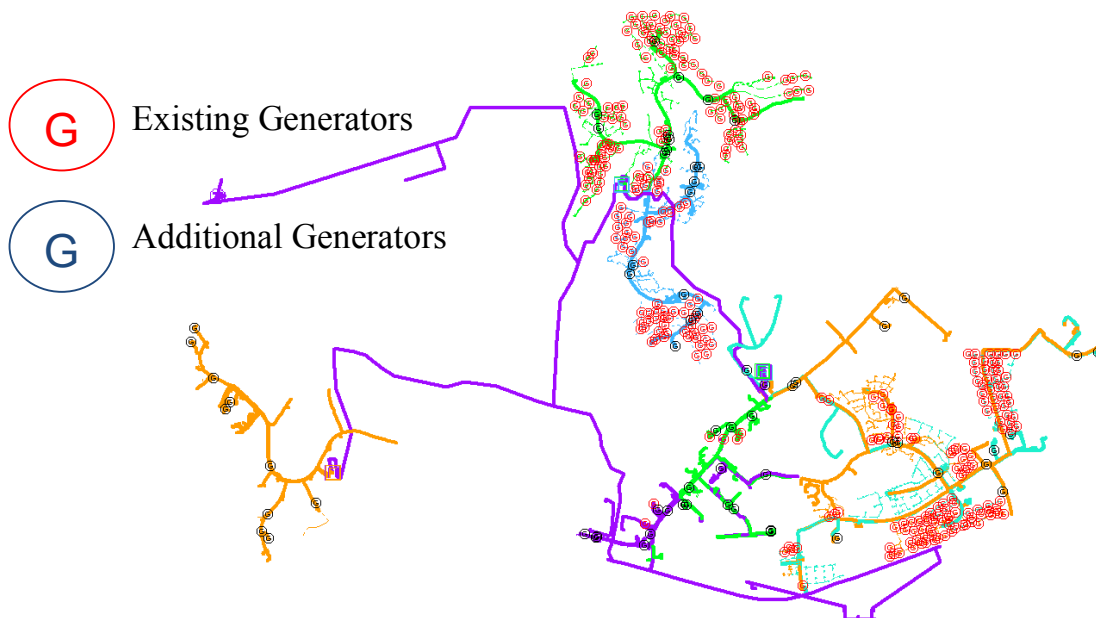

Figure 2.6. Cluster B PV Locations.

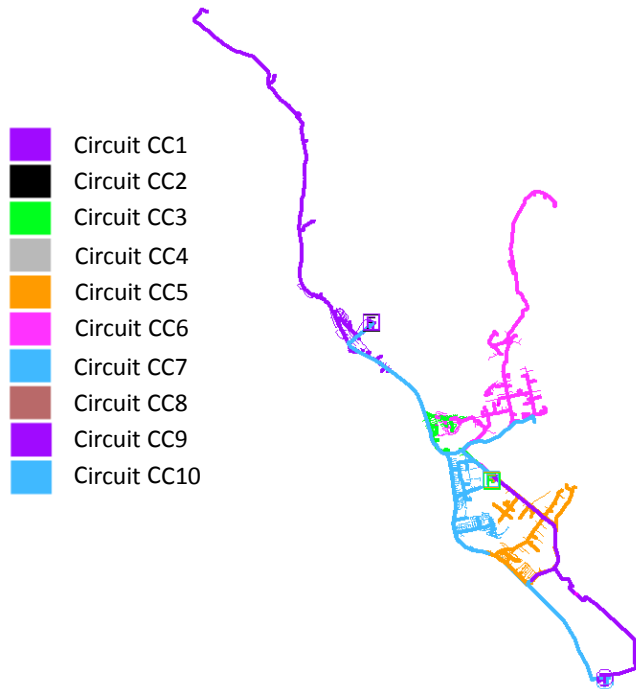

Figure 2.7 Cluster C Feeder Map.

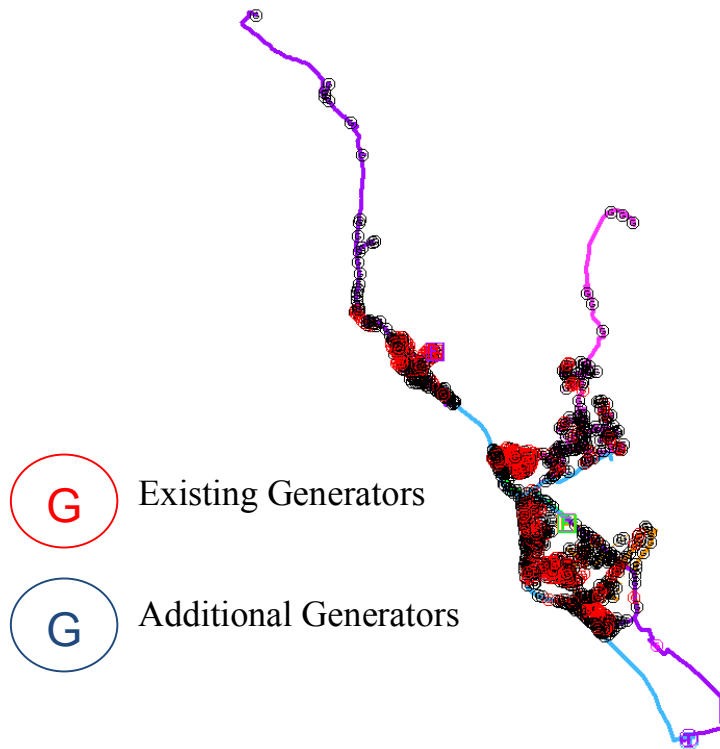

Figure 2.8 Cluster C PV Locations.



Once the Feeder Model is extracted, consistency checks are performed to verify that the model representation of the conditions on the feeder is accurate. Checks include

- Conductor and equipment specifications or closest equivalent representations exist in the modeling database;
- Sub-station connections and equipment are checked for connectivity and correct settings;
- Peak load analysis to double check for line loading violations and ensure appropriate conductor specifications being used; and,
- Levels of PV in the model match location and size by customer installation for feeder.

## 2.2 Evaluation Criteria and Analysis Scenarios

The method of analysis is designed in order to assess the integrated distribution and transmission system with respect to various evaluation criteria or conditions, for a number of different PV penetration levels. A number of different PV penetration scenarios are created and simulation runs conducted using the models. The scenarios are made up of different combinations of load profiles, installed PV capacity, and PV output (how much of that capacity is being generated). Sections below provide descriptive details for the feeder loading profiles, evaluation criteria, and range of PV penetration levels assessed.

### 2.2.1 Load Profiles

For modeling studies, analyses are typically conducted to account for worst case or extreme conditions based on historical load to be served. On distribution feeders, the planning focus is around the two extreme boundary cases:

- A condition of minimum loading on the feeder and the system
- A condition of peak loading on the feeder and the system.

As the impact of PV is of interest, Proactive Studies have included an additional study condition focused on the daytime load profiles, especially concentrating on times when the PV systems are likely to be operating at full output. Figure 2.1 shows an example of two feeders (Breaker A and Breaker B) that have peak loads during the morning (Breaker A around 9:30am) and daytime period (Breaker B from 6:40am to 4pm) which is non-coincident with system peak loads that occur around 7:30pm-8:00pm at night.

At first glance, customers on these feeders would benefit from installing PV to offset their demand during the day since their loads are coincident with the peak solar production during the day. However, upon further investigation, the weekend loads on these two feeders, even during the daytime, are significantly lower than the weekday loads on the feeder. If PV were installed to maximize production to meet customer demand (based on weekday loads), then every weekend, these feeders would potentially be backfeeding onto the transmission system. These feeders are already lightly loaded during the weekends; interconnection analysis would likely have to assess backfeed of excess solar generation onto nearby feeders, bi-directional monitoring and protection device impacts upstream of the distribution feeder. As such, proactively assessing cluster-level impacts would provide visibility to how the load profiles are changing from historical profiles due to PV penetration, how different load profiles can be depending on the type of loads on the feeders (residential, industrial, commercial), and how PV impacts different feeders.

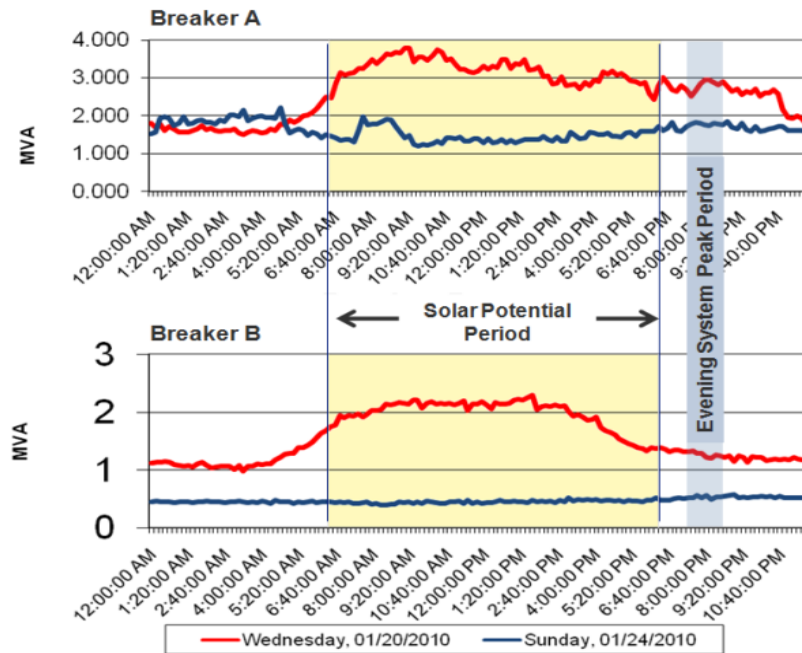

Figure 2.1. Feeder loading during weekday and weekend and compared to system peak.

Once the historical peak and minimum daytime load profiles are obtained, power flow analysis can be conducted using models like SynerGEE to model varying levels of PV (different scenarios) ranging from zero up to upper threshold of the historical peak conditions on the feeder. Results of simulations are presented in Section 3.0.

For purposes of this study effort, the upper threshold was selected at a high level at 135%, meaning the solar penetration on that circuit is 135% of the circuit’s peak load (in addition to several intermediate levels) so that adverse conditions would be encountered and the maximum allowable threshold could be identified by backing down to intermediate levels. Fault current analyses are also run at each of the specified PV penetrations. During a short-circuit fault, the resistance of the section of the circuit where the fault occurs is reduced to near-zero, resulting in a massive increase in the current – this increased current is known as the fault current. Fault current analysis is used to calculate the magnitude or size of the available fault current. Installation of PV inverters typically increases the available fault current, and it is important for the protection systems (such as circuit breakers) to be rated to operate with the maximum available fault current on the circuit.

As PV output changes throughout the day and can range from clear, cloudy and highly variable all in one day, clear day and cloudy day solar production profiles are also introduced. While simplified assumptions for clear day (100% production from PV systems) or some reduced production for cloudy conditions (20% production from PV systems) can be used for steady state (SynerGEE) analysis, actual PV irradiance and production profiles are needed for dynamic models (PSS/E) to capture variability of distributed PV resources across the island and to investigate impact of variability on system response. Figure 2.2 shows solar monitoring devices used by Hawaiian Electric to capture solar irradiance. Figure 2.3 shows an example of generation profiles from a single PV system used for modeling and validation needs.



Figure 2.2. Diverse field monitoring devices for measuring solar resource.

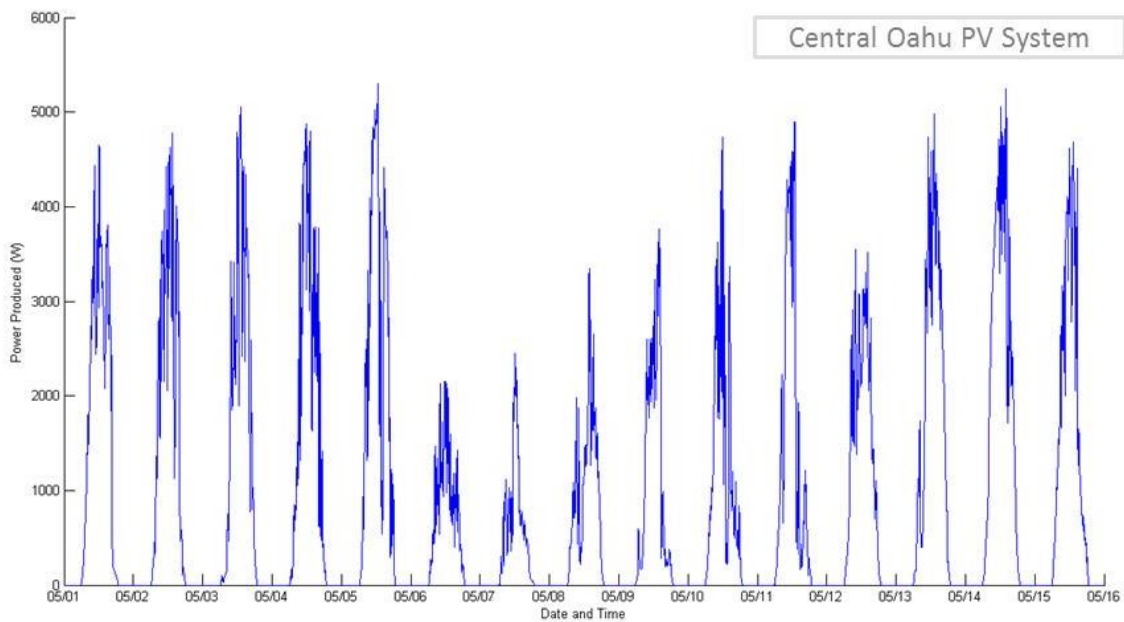

Figure 2.3. Solar PV system production profiles over a 2 week period.

For the Proactive Modeling Approach, in order to account for distributed PV within dynamic models, the individual roof-top PV systems on the feeders are aggregated as representative PV generators and modeled as generating resources versus negative load. Figure 2.4 illustrates how

the load (blue down arrow) and distributed PV (yellow circle) at the 12kV level can be aggregated as equivalent load and distributed generation onto to the transmission system (linkage shown in red).

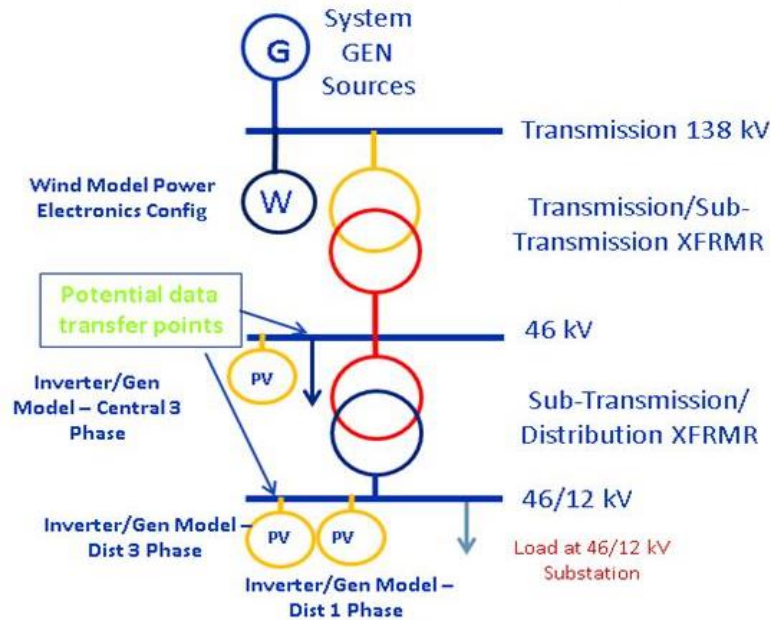

Figure 2.4. Modeling representation of equivalent load and aggregated distributed generation for transmission level analysis.

Time variant PV profiles representative of aggregated distributed PV generators can thus be incorporated and used to investigate impact of distributed PV on the system using the PSS/E model. Initial dynamic results presented in Section 4.0 provide insight on system and aggregated distribution level response under transient conditions (fault of line or generation) and N-1 contingency events. N-1 is a condition of a single failure of a line or generator on the system.

### 2.2.2 Technical Criteria for Evaluation

The evaluation criteria (or Technical Criteria) described in this section are used to identify conditions or issues that impact the grid which may preclude additional PV penetration onto the circuits. Technical Criteria are defined based on a technical problem that would be caused on the electrical system with increasing levels of exceedance.

For steady-state analysis, Table 2.1 lists the Technical Criteria, associated limits and associated effects and impacts. Table 2.2 lists the Technical Criteria pertaining to dynamic modeling analysis conducted as part of this report.

Table 2.1. Technical Criteria for Steady-State Analysis.

Technical Criteria	Limit	Effects and Impacts
<b>Backfeed</b>	Reverse power flow as output of distributed generation exceeds feeder load	Existing distribution system equipment (such as transformers) have control systems that are set up to handle power flow in one direction only – from the transmission system through the distribution system to the customer. When power flow reverses at the transformer, the existing control systems may not recognize the change in direction and only sense the magnitude of the power. This can result in voltage regulation equipment moving in the wrong direction, causing increasing voltage problems.
<b>Load Tap Changer (LTC) Position</b>	Change in LTC position due to variation in PV output between 100% - clear day and 20% - cloudy day	The LTC is a voltage regulation device integrated into the transformer. In order to maintain the voltage on the distribution system within a specified band-width, it can increase or decrease the transformer voltage ratio incrementally when system load or generation conditions change. If the number of LTC position changes increases, this can cause a decrease in the service life of the equipment, and require more frequent maintenance or replacement.
<b>Thermal Loading</b>	Line loaded over 100% of specified capacity	If a line section is overloaded it can over-heat, causing potential damage to the equipment itself or surrounding structures.
<b>Voltage</b>	Voltage at any point on the distribution system is less than 95% or greater than 105% of nominal.	Customers would experience high or low voltage problems which can damage appliances and service may be lost if voltage remains outside nominal $\pm 5\%$ .
<b>Fault Current</b>	Short circuit contribution ratio of all generators connected to the distribution system is greater than 10% (California Rule 21 and Hawaii Rule 14H criterion) or 5% (Hawaii internal criterion).  The two criteria given trigger more detailed studies of protective equipment capacities. The 10% value comes from the Electric Rule No. 21 document, while the 5% value is a limit that	Increases in fault current may require upgrading of protective equipment on the system. Circuit breakers at the sub-stations are rated for a maximum level of fault current, and if this value is exceeded the breakers may not function as required, causing damage to equipment and required replacement.

has been communicated to DNV GL by HECO in previous projects, likely due to some of their distribution circuits being more sensitive to increases in fault current.

Table 2.2. Technical Criteria for Dynamic Analysis.

Technical Criteria	Limit	Effects and Impacts
<b>Under Frequency Inverter Trip</b>	During an N-1 analysis, additional load shedding occurs compared to event occurring with no PV installed.	If PV inverters trip due to under-frequency during a transient event, this can lead to a cascading loss of generation, to which the electrical system responds by shedding load (blackouts) in order to balance the load with the reduced available generation.
<b>Over Voltage Inverter Trip</b>	During an N-1 analysis, additional load shedding occurs compared to event occurring with no PV installed.	As above, during a rapid reduction in generation due to inverters tripping, the voltage may increase, which again can be alleviated in the short term by the electrical system shedding load.

Technical Criteria define the adverse conditions that would result on the electrical system due to exceedance of the described limit and the resulting effects/impacts. For example, backfeed occurs when the output of distributed PV exceeds the customer demand or load on the circuit and may require upgrades to install bi-directional monitoring devices to detect power flow reversals and reviews of proper response from voltage regulating devices, if the backfeed situation cannot be mitigated in another way. Through simulation-based modeling of an increasing range of PV levels, the threshold of backfeed condition on circuits can be determined, a priori, so monitoring devices and assessments can be proactively performed.

### 2.2.3 Range of PV Penetrations & Scenarios

For both the steady-state and dynamic analyses, scenarios are established and used to run the models. The scenarios are a means of capturing a variety of conditions of interest with varying degrees of sensitivity between the different conditions. The Proactive Approach Modeling methodology was developed to identify a list of scenarios that would capture all major conditions on the grid rather than developing a new custom list for each study. With automation introduced into the modeling runs, covering an extensive list of conditions does not have a significant impact on the time it takes to complete the analysis.

The different scenarios for each of the steady-state parameters are shown in the Figure 2.3. Note, the analysis is carried out up to 135% of peak load as a modeling criteria and not necessarily indicating that 135% of peak load can be interconnected. This is an extreme level with the

intention of creating an adverse issue and then backing down to identify at what penetration level begins to create the condition.

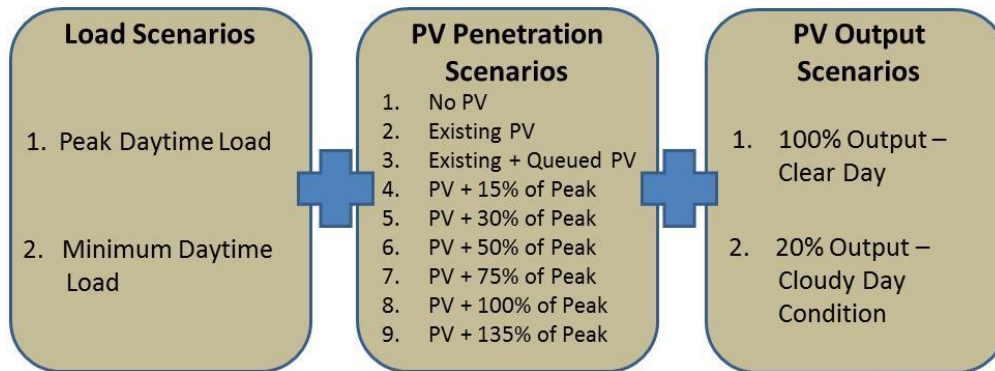

Figure 2.5. Scenario Combinations

By forming all possible combinations of the above options, 34 steady-state cases are defined as listed in Figure 2.5. Note that the existing PV and queued PV penetration levels vary by individual circuit and can vary from 0% to 135% of peak load, and for some circuits even higher than 135% of peak load. Though many of the circuits already have existing installed PV, a “No PV” scenario is created to establish a common baseline for comparison between “No PV” and the “Existing PV” scenarios. “Existing + Queued PV” accounts for another gradation of PV installed on the feeder and accounts for known and approved to be installed PV on the circuit. “PV + 15% of Peak” through “PV + 135% of Peak” identify a systematic range of increasing PV on the feeder. Analyzing the range of scenarios provides planners better understanding for which feeders within the cluster begin to exhibit change first, at what level of PV do exceedance levels begin to occur given the Technical Criteria and what happens at extreme exceedance levels (hopefully attained at or near 135%). The scenarios allow planners to simulate the response of the system at high penetrations, without actually exposing the system to any risks and to consider appropriate and cost-effective mitigation measures that have the most value in resolving conditions for both distribution level and system levels.

Table 2.3. Scenario Definitions.

Case Name	Load Profile	Installed PV Penetration (% of Peak Load)	PV Output
Case 1	Peak	0%	0%
Case 2	Min	0%	0%
Case 3	Peak	Existing	100%
Case 4	Min	Existing	100%
Case 5	Peak	Existing	20%
Case 6	Min	Existing	20%
Case 7	Peak	Existing + Queued	100%
Case 8	Min	Existing + Queued	100%
Case 9	Peak	Existing + Queued	20%
Case 10	Min	Existing + Queued	20%
Case 11	Peak	15%	100%

<b>Case 12</b>	Min	15%	100%
<b>Case 13</b>	Peak	15%	20%
<b>Case 14</b>	Min	15%	20%
<b>Case 15</b>	Peak	30%	100%
<b>Case 16</b>	Min	30%	100%
<b>Case 17</b>	Peak	30%	20%
<b>Case 18</b>	Min	30%	20%
<b>Case 19</b>	Peak	50%	100%
<b>Case 20</b>	Min	50%	100%
<b>Case 21</b>	Peak	50%	20%
<b>Case 22</b>	Min	50%	20%
<b>Case 23</b>	Peak	75%	100%
<b>Case 24</b>	Min	75%	100%
<b>Case 25</b>	Peak	75%	20%
<b>Case 26</b>	Min	75%	20%
<b>Case 27</b>	Peak	100%	100%
<b>Case 28</b>	Min	100%	100%
<b>Case 29</b>	Peak	100%	20%
<b>Case 30</b>	Min	100%	20%
<b>Case 31</b>	Peak	135%	100%
<b>Case 32</b>	Min	135%	100%
<b>Case 33</b>	Peak	135%	20%
<b>Case 34</b>	Min	135%	20%

For each of these cases, 24 steady-state load flow analyses are performed to represent a six-hour segment of the day – 10am to 4pm – split into 15-minute intervals. For each of these time-steps, only the load value was changed, the installed generation and the generator output remained fixed at their specified values. The 24 cases are used to assess the different Technical Criteria (conditions) as described in Table 2.1. Table 2.4 provides a description of the compliance and exceedance levels for each of the Technical Criteria listed in Table 2.1. Descriptions further elaborate on the degree of severity and analysis treatment if the Technical Criteria is exceeded.

Table 2.4. Compliance with and Degree of Exceedance with Respect to the Technical Criteria.

Technical Criteria	Assessment of Degree of Exceedance of Technical Criteria
Backfeed	<ul style="list-style-type: none"> <li>The backfeed study is performed by identifying the minimum daytime load on the feeder. As it is assumed that the PV output could be at 100% at any time between 10am and 4pm, this minimum load represents the PV penetration at which reverse power flow may occur.</li> <li>Backfeed results are reported both at the feeder level and at the transformer level. On the Hawaiian Electric system, each distribution transformer may have from 1 to 3 distribution feeders connected, and there may be the situation where one of these feeders' experiences reverse power flow at the feeder head while the others</li> </ul>



	do not. In this case there may still be voltage control issues on the feeder with reverse power flow, even though there is not reverse flow through the transformer, and as such it is important to be aware of when this condition may occur. The case where there is reverse power flow at the transformer is a more obvious problem as the voltage regulation systems must then be set up to recognize the direction of power flow and act accordingly.
LTC Cycling	<ul style="list-style-type: none"> <li>In order to identify any LTC Cycling violations, for each load and PV penetration case the PV generator output is varied between 100% and 20%. For the same time-step (and therefore same customer load) the LTC position is compared for the two different PV outputs. As all other parameters remain the same, any change in LTC position can be attributed solely to the change in output of the PV generators connected to the circuit. If the LTC position changes, this constitutes a violation.</li> </ul>
Thermal Loading	<ul style="list-style-type: none"> <li>For each load flow analysis performed, the maximum continuous current on each feeder is calculated. Again, the first two cases are checked first to ensure that the customer load alone is not causing load violations. After these are verified, the maximum continuous loading on the feeders for all the other cases is calculated. If the continuous loading is above 100% on any section, this constitutes a violation. As with the voltage results, if a violation is found then the location and reason for the violation (if it is identifiable) is identified and presented.</li> </ul>
Steady-state Voltage	<ul style="list-style-type: none"> <li>For each load flow performed, the maximum and minimum voltage on each feeder is calculated. If these values are within the range 95% to 105% of the nominal voltage then there is no violation. If either the maximum or minimum voltage is outside this range, there is a violation. If the violation occurs in either case 1 or case 2 in Table 2.1.3 above (when there is no PV installed), then the model is checked to identify any inaccuracies as it is generally assumed that there should not be any voltage violations in an existing condition.</li> <li>If voltage violations occur outside of the first two cases, the location of the violation is identified and presented.</li> </ul>
Fault Current Rise	<ul style="list-style-type: none"> <li>The fault current rise study is performed by comparing the maximum fault current for each PV penetration scenario to the maximum fault current when no PV is installed. The results are important for protection systems coordination, and there are two criteria checked: 5% fault current rise (from no-PV condition) and 10% fault current rise (from no-PV condition).</li> </ul>

For high penetration PV, many of the traditional “rules-of-thumb” for compliance and exceedance levels may need to be reconsidered and will take time to evaluate. Planning studies such as these are being conducted by a number of utilities across the world and helping to inform standards development as the electrical grid transforms to accommodate a more diverse generation portfolio. Efforts are also currently underway by the Institute of Electrical and Electronic Engineers (IEEE), Federal Energy Regulatory Commission (FERC) and Underwriters Laboratory (UL) to revise standards that accommodate high levels of variable, distributed resources.

## 2.4 Model Assumptions and Input Data Requirements

The following assumptions are implicit in the cluster study process:

1. PV generation will grow in areas where there are existing customers;
2. Transformer and other voltage regulation equipment settings remain constant;
3. All installed PV generators were functioning and output was directly proportional to measured irradiance during the period of load measurement; and,
4. 100% output of installed PV could occur at any time between 10am and 4pm on any given day.

Table 2.5 shows the data requirements for each of the Technical Criteria identified in the Table 2.1.

Table 2.5. Data Required for Technical Criteria.

Technical Criteria	Data Required
Backfeed	Minimum load value in kW.
LTC Cycling	Peak and minimum load profiles, sub-station data to allow transformer operation to be validated.
Thermal Loading	Peak and minimum load profiles, and feeder model with conductor and other equipment specifications in order to identify current-carrying capacity.
Voltage	Peak and minimum load profiles, feeder and equipment data, sub-station data to allow transformer operation to be validated.
Fault Current Rise	Feeder model with equipment ratings and electrical properties.

In some cases there may be insufficient data on feeders to conduct all these analyses.

- Where feeder measured load data is unavailable, the feeders have been identified and prioritized for monitoring to ensure that actual data will be made available in the future, especially for critical circuits (e.g. feeders with large amounts of PV).
- Depending on the urgency of need, proxy analysis using data from a similar type of feeder can also be used, however for purposes of this present report and within given time constraints, feeders with no measured load data are marked for later analysis. While this precludes conclusions to be drawn on that feeder, evaluation can still proceed as part of the cluster evaluation and as information becomes available for the feeder, analysis can be included.

For Oahu, there are circuits for which an accurate Feeder Model is unavailable or incomplete to the utility due to the feeder being owned by a specific customer and the layout being confidential (such as at the Department of Defense military installations and the University of Hawaii at Manoa campus). In these cases, utility assumptions are made to model the feeder as a single line section of a certain length, with equivalent generators and a load.

- Where feeder models are unavailable, there is no immediate intention to create models for these feeders as they are customer-owned. These cases are identified in the cluster analysis results in Section 3.0 of this report.
- Additional detailed modeling is typically not recommended until more information for the feeder can be provided.

### 2.4.1 Minimum and Peak Daytime Load Profiles

As discussed in Section 2.2.1, for the cluster analysis, it is required that a minimum daytime load profile based on historical data from the feeders be identified, as well as the peak daytime load profiles for each cluster. In this case, 'daytime' refers to the period between 10am and 4pm where the PV output could be at 100% production. This cluster profile development produces a 24 hour load profile presented in 15-minute intervals resolution. For initial analysis, the data was screened for days with missing data and unusual load switching – resulting in non-representative high demand on the circuit (Figure 2.6).



Figure 2.6. Example of load switching on the feeder where load was unusually high for a short period of time.

The load profiles are intended to represent the total energy to supply customers. The demand data is what is measured at the substation and is effectively the net load or actual energy supplied by the utility to the customers. With more PV production on a circuit (sunny day), the net load or demand measured at the substation decreases since part of the demand is served by local generation from roof-top PV. As production of electricity from PV on the circuit decreases (such as on a cloudy day with less solar resource), demand measured at the substation will increase.

The normal process of obtaining the load profile is to start from the demand data (measured at the substation) and add the estimated output from the PV generators on the circuit based on locally measured irradiance for the same period. Figure 2.7 shows an example of how the load, demand, and the load masked by the PV are related.

In this chart, the blue area represents the ‘demand’, which is the load measured at the substation. The green area represents the estimated PV generation profile on the feeder for the day in question, which masks some of the actual load used by the customers. The red line represents the actual load used by the customers connected to the circuit, obtained by adding the masked load to the demand measured at the substation.

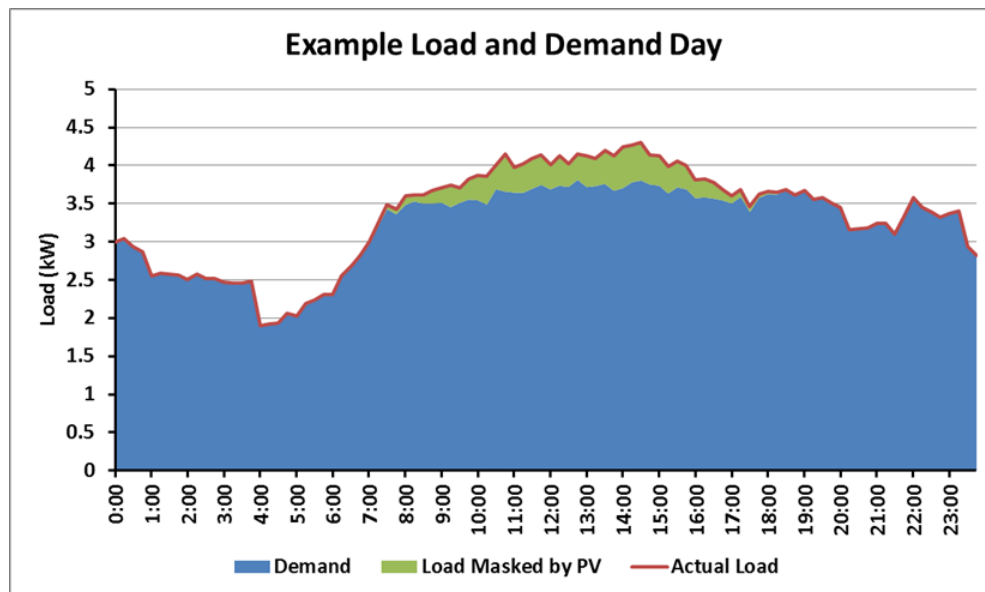

Figure 2.7. Profiles of Total (Actual) Load, Demand (Net Load) and Load Masked by PV.

Demand data is measured by the utility based on coverage of their SCADA (Supervisory Control And Data Acquisition) and monitoring devices and telecommunication services. Traditionally, not all distribution feeders (12kV) are directly or individually measured. For some of the feeders with no monitored data, an estimate of the load on these feeders can be made by taking the summation of all feeder demand served at the 46kV level (which is monitored by SCADA) and subtracting all known 12kV feeder demand on the 46kV line, leaving the remaining demand on the feeders without measurement. Thus, this remaining demand is allocated to the remaining feeders in proportion to their historical peak load values. Peak loads are determined for each circuit on an annual basis by the utility and is derived from the SCADA data where available. For circuits without any SCADA information, temporary monitors are sometimes used to collect the load data for a short period of time to periodically assess conditions.

With higher PV penetrations, there is a growing need to deploy monitoring and categorize the feeders by customer load types to accurately assess impacts and track change. For the purposes of this report and within the given timeframe of analysis, feeders without SCADA data or ability to derive using the summation of feeders, are identified for monitoring and later analysis.

### 2.4.2 Validation Data and Process

Data is required to verify that the results obtained from the analysis in the model are consistent with those that occur in real life. The parameters that can be checked are the voltage and the transformer LTC (Load Tap Changer) position. In order to check these results, data for a one-day profile of demand (kW, kVAR and kVA), voltage measured at the transformer and LTC position, is desired. This data is used to validate the operation of the transformers.

Validation data is used to check that the transformer is set up correctly and that the voltage (and LTC position data, if available) is correct for a given input demand. The first step in this validation process is to check the transformer Line Drop Compensation (LDC) settings. LDC is the control process used on an electrical system to ensure that the voltage at the end of the circuit is within an acceptable range. The acceptable range is defined as the LDC voltage set-point, plus or minus a specified band-width. As the length of the circuit increases, the voltage at the end of the circuit drops due to electrical losses in the conductors. In a traditional distribution system, the voltage is only measured at the transformer, so the LDC system is used to calculate the approximate voltage at a specified point in the circuit (usually the end). The LDC system can then instruct the voltage regulation equipment at the transformer to adjust the voltage up or down in order to compensate for the drop in voltage along the circuit.

The objective of the validation analysis is to ensure that, for a given load profile on the circuit, the voltage regulation equipment produces the correct corresponding voltage at the transformer.

To perform the validation analysis, the load on the system is first adjusted such that it is within an acceptable range of the measured value provided by the utility.

Once this is achieved, the voltage is checked against the measured value. In this case, the voltage is to be within the LTC band-width of the measured value. As no band width is given for the HECO transformers, this is normally selected as 0.75V (on a 120V base), which is the smallest band-width available in SynerGEE. The reason for selecting the smallest band-width is that this ensures that the LTC will change position most frequently, and thus represents a conservative assumption with regard to the LTC Cycling criterion described earlier.

If the analyzed voltage is not within the acceptable range for the given input demand, the LTC voltage setting is adjusted to find a setting that would produce acceptable results. Any changes to the LTC voltage settings are noted in the validation reports. Once the voltage is checked, the LTC position is also checked (if the data is available). The criterion for this is that the analyzed LTC position should be within one step of the measured position.

## 3.0 RESULTS – STEADY STATE

This section presents the results of the steady-state analysis for three Electrical Clusters on Oahu. As shown in Figure 1.1, the three clusters are considered high penetration, have a diversity of customers (residential, commercial and industrial) and feature line lengths that range from short to long.

- Electrical Cluster A: Southwest Region , primarily residential, mix commercial
- Electrical Cluster B: Halawa Region, mixed residential, commercial and industrial

Hawaiian Electric Company

Task 3 Deliverable – Draft Cluster/Circuit Analysis Results

- Electrical Cluster C: West Region, primarily commercial, mix residential

Steady state analysis is used to evaluate how stable the system is due to slow and steady change conditions over the course of the day. For each of the clusters, a general description of the circuit, data availability and any missing data is provided and discussed. While not all circuits will have complete data, sufficient data is necessary to conduct validation checks and establish a confidence level for the conditions simulated and technical limits identified. Successful validation of basic parameters such as the demand and voltage provide a sense of confidence that the modeled results reflect reality. When validation parameters are outside validation range, there may be uncertainty in the model or the quality of the data which warrants further investigation. Through the Proactive Approach process, distribution feeders can be evaluated and validated. Results are also presented in a consistent fashion – graphical and tabular formats are presented for each cluster to facilitate analysis and also to compare results from one cluster to another. For each cluster, this report will provide the following:

- 1) Peak and minimum loading profiles for each feeder
- 2) Results of the validation and issues identified
- 3) Technical thresholds on feeders and existing PV levels
- 4) Summary of results

### 3.1 Electrical Cluster A Evaluation Results

Electrical Cluster A represents a typical group of feeders serving primarily residential customers. Located in the Southwest Region this area has good solar resource. The analysis covered 8 feeders (CA1 through CA8) serving this community, representing short to medium in length (within 1 mile in length) connected to 4 separate transformers (TA1, TA2, TA3, TA4). Table 3.1 presents the distribution circuits included in the analysis, the transformer they are connected through, the SLACA (historical peak load) value and the existing and queued PV generation on the circuit. Table 3.2 shows which data was available for the distribution circuits included in the study.

Table 3.1 Electrical Cluster A Distribution Circuit Data.

Distribution Circuit	Transformer	SLACA (kW)	Existing PV (kW)	Queued PV (kW)
CA1	TA1	1062	312	0
CA2	TA1	3531	1244.67	0
CA3	TA2	3007	127.75	240
CA4	TA2	520	0	0
CA5	TA3	4106	51.45	180
CA6	TA3	2628	844.34	0
CA7	TA4	1688	361.6	0
CA8	TA4	2412	288.94	200

Table 3.2 Electrical Cluster A Data Availability.

Feeder	SCADA/BMI	Feeder Model	Validation Data
CA1	Yes	Yes	Yes
CA2	Yes	Yes	Yes
CA3	Yes	Yes	Yes*
CA4	Yes	Yes	Yes*

CA5	Yes	Yes	Yes*
CA6	Yes	Yes	Yes*
CA7	Yes	Yes	Yes*
CA8	Yes	Yes	Yes*

\* LTC data not available, only voltage data for validation

Based on the data review, not all feeders have sufficient measured data to complete the different analysis. In this case as a number of the feeders do not have LTC data for validation, thus the LTC position results will not be reported. For feeders with available data, if validation is successful, the following results will be provided.

- CA1, CA2 All results are reported
- CA3 to CA8 Backfeed, Loading, Voltage and Fault Current Rise results reported, no LTC results presented

### 3.1.1 Electrical Cluster A Load Profiles

Figure 3.1 shows the loading profiles on the different feeders on Cluster A for a minimally loaded day (minimum load day). Figure 3.2 below shows feeder loadings on a highly loaded day (peak load day). The profiles are shown over the 10am to 4pm period of analysis for high penetration conditions. Graphically, these feeders can be reviewed for highest loaded feeder, lowest loaded feeder, most peaky load feeder and feeder with limited change between minimum and peak load conditions. For example, the average loading on feeder CA3 changes from about 3 MW minimum loading to over 5 MW at peak loading conditions. Feeder CA2 has loads that exhibit a “peaky” load which may be indicative of customer loads that have a lot of on-off conditions. Other feeders like CA5 remain relatively steady in terms of loading around 3 MW in either minimum or peak conditions.

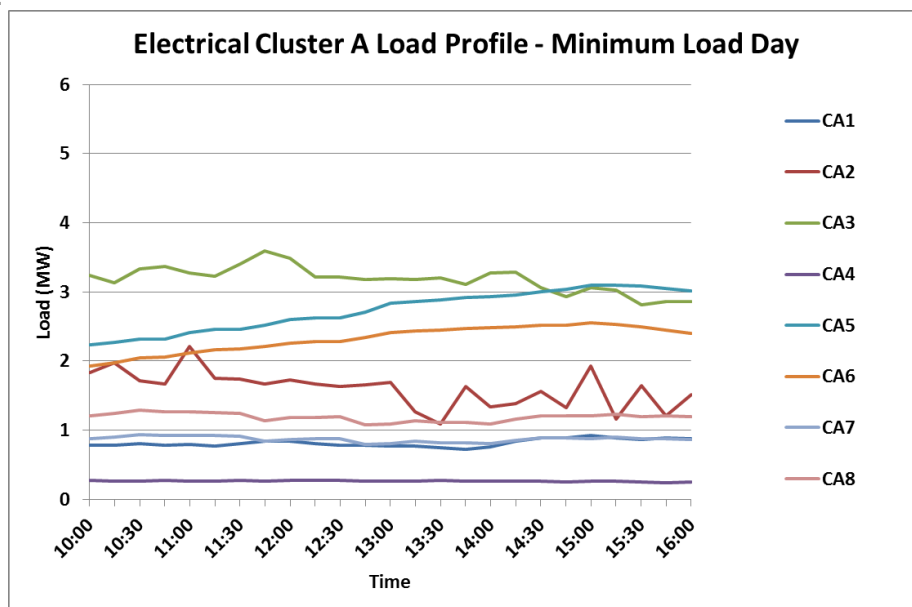

Figure 3.1. Electrical Cluster A Minimum Load Profiles.

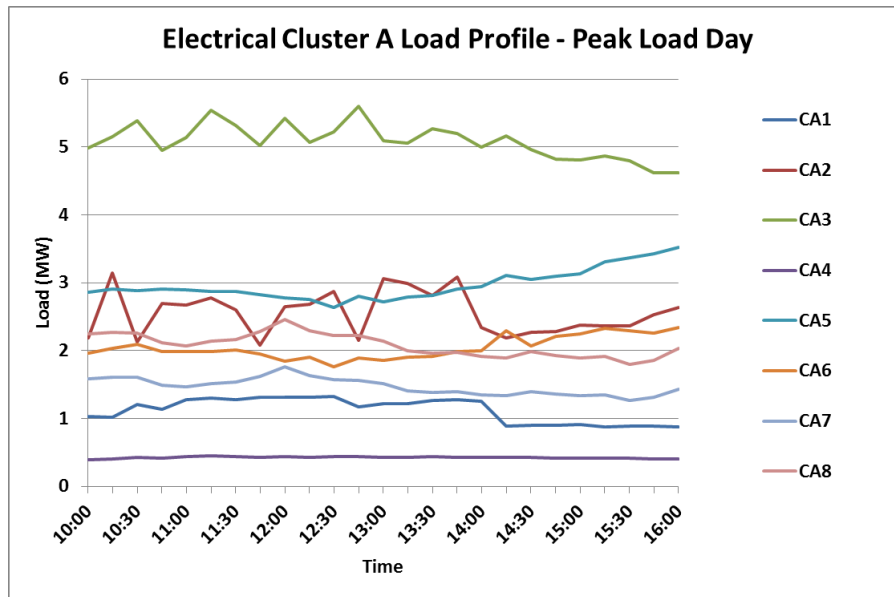

Figure 3.2. Electrical Cluster A Peak Load Profiles.

### 3.1.2 Electrical Cluster A Validation

The validation data for the four transformers in the model – TA1, TA2, TA3 and TA4 – are shown in Figures 3.3 to 3.6 below. For each transformer, the acceptable demand profile is shown on the left, along with the profile that is modeled. These should demonstrate that the demand entered into the SynerGEE model was within 1% of the measured value for both kW and power factor (pf in the chart below). The blue areas on the chart represent the acceptable range for both the kW demand (dark blue) and power factor (light blue). If the solid green line – which represents the kW demand obtained from the model – runs through the dark blue area, this shows that the kW demand has been modeled within the acceptable range (the measured demand +/-1%). If the orange line remains within the light blue area, this shows that the power factor has also been modeled within the acceptable range (measured power factor +/-1%).

The chart on the right in each case shows the corresponding voltage profile at the transformer. The acceptable range is the measured voltage value in the data provided by the utility  $\pm 0.75V$  (on a 120V base). In cases where alterations are required to the LTC voltage set-point in order to bring the voltage profile within the acceptable range, the original voltage set-point is also shown. The chart on the right also shows the LTC position validation, where data is available.

If the voltage and LTC position can be validated, it shows that the SynerGEE model of the transformer produces results consistent with those observed on the real system. This check provides a degree of confidence in the analysis to report results. If either of these parameters cannot be validated, then there may be too much uncertainty in the results from the SynerGEE model, and the results are considered un-validated. For this report, un-validated parameters will not be reported.



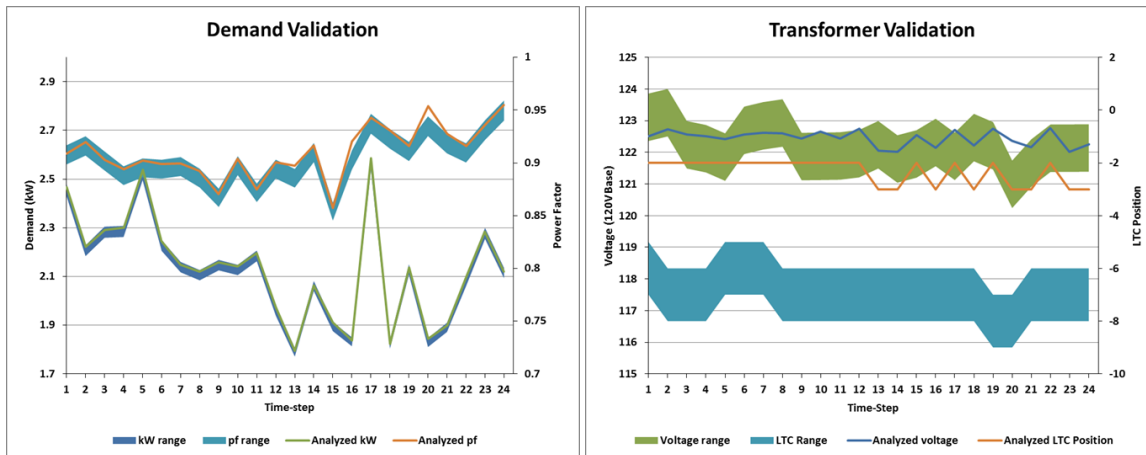

Figure 3.3. TA1 Transformer Validation Results.

The chart on the left in Figure 3.3 shows that the demand was modeled within the acceptable ranges for most of the time-steps. The chart on the right shows that the voltage profile also stays within the acceptable range for all but one of the time-steps. For the time-step where the voltage is out of range, the demand chart shows that the power factor was not modeled within the acceptable range, so the result for this one time-step can be excluded. The voltage behavior is therefore validated for this transformer and the voltage results from the analysis will be reported. As the LTC position could not be modeled within the acceptable range, it is not possible to validate the LTC operation given the existing information and additional investigation is warranted. For purposes of this study, the LTC position results for this transformer are therefore not reported.

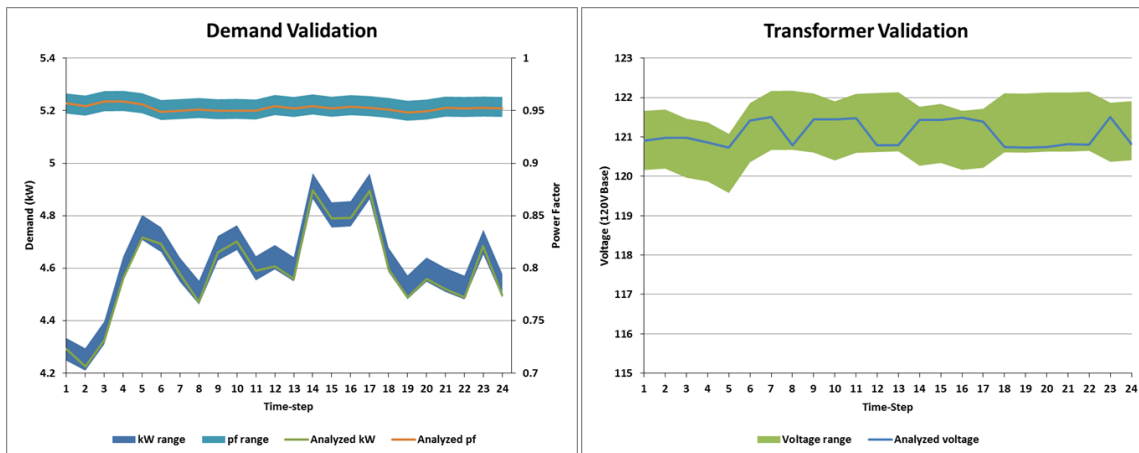

Figure 3.4. TA2 Transformer Validation Results.

The chart on the left in Figure 3.4 shows that the demand is modeled within the acceptable ranges for all of the time-steps. The chart on the right shows that the voltage profile also stays within the acceptable range for every time-step, so the voltage behavior of the transformer can be considered validated and voltage results will be reported for this feeder. As LTC position data is not available for this transformer, the LTC position results are not reported.

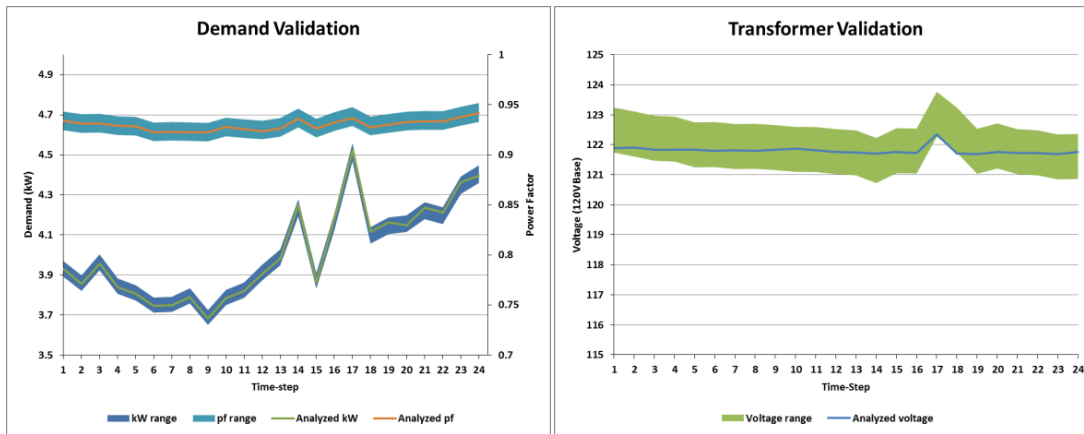

Figure 3.5. TA3 Transformer Validation Results.

The chart on the left in Figure 3.5 shows that the demand is modeled within the acceptable ranges for all time-steps. The chart on the right shows that the voltage profile is also within the acceptable range for all time-steps, so the voltage behavior of this transformer can be considered validated and voltage results can be reported. As LTC position data is not available for this transformer, the LTC position results are not reported.

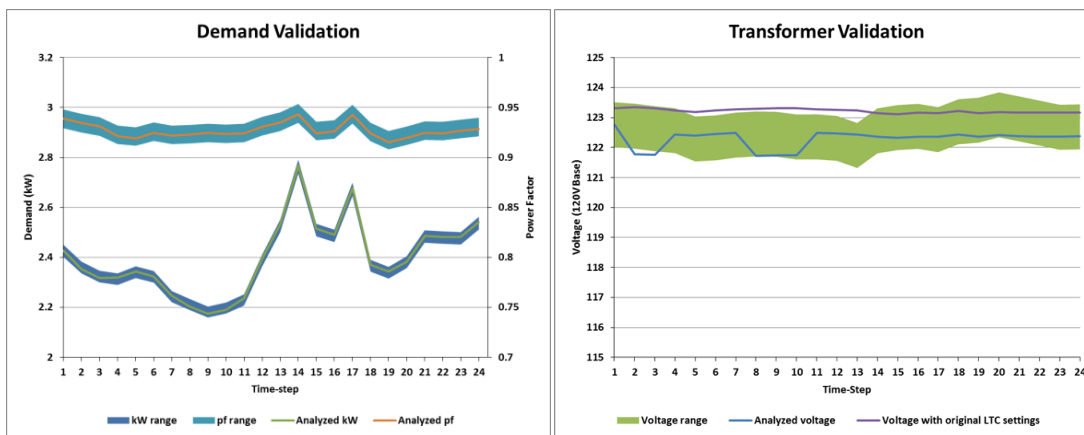

Figure 3.6. TA4 Transformer Validation Results.

The chart on the left in Figure 3.6 shows that the demand is modeled within the acceptable ranges for all time-steps. The chart on the right shows that the voltage profile is not within the acceptable range using the original LTC voltage set-point of 123V. An adjustment of the voltage set-point down to 122V brought the voltage profile within the acceptable range for all but two time-steps, which can be considered acceptable. The voltage behavior of the transformer is therefore considered validated while noting that the LTC voltage set-point had to be adjusted. As LTC position data is not available for this transformer, the LTC position results are not reported.

### 3.1.3 Electrical Cluster A Results

Table 3.3 and Figures 3.7 and 3.8 summarize the results for the distribution circuits on Electrical Cluster A. Table 3.3 tabularizes the circuit conditions and PV penetration levels provided at the time of the study and corresponding backfeed, voltage and loading thresholds assessed.

Table 3.3. Electrical Cluster A Distribution Circuit Results.

Distribution Circuit	SLACA (kW)	Existing PV %	Existing + Queued PV %	5% Fault Current Limit	10% Fault Current Limit	Backfeed Limit	Voltage Limit up to 135%	Loading Limit up to 135%
CA1	1062	29.38%	29.38%	N/A	N/A	68%	None	None
CA2	3531	35.25%	35.25%	N/A	N/A	31%	None	None
CA3	3007	4.25%	12.23%	N/A	N/A	96%	None	None
CA4	520	0.00%	0.00%	N/A	N/A	48%	None	None
CA5	4106	1.25%	5.64%	N/A	N/A	54%	None	None
CA6	2628	32.13%	32.13%	N/A	N/A	66%	None	None
CA7	1688	21.42%	21.42%	N/A	N/A	46%	None	None
CA8	2412	11.98%	20.27%	N/A	N/A	44%	None	None

1. N/A = Not Available (will not be completed within the timeframe of this project)
2. Where limit is given as 'None', this should be understood as 'no limit was found up to PV penetration of 135%'. Limits may exist at higher penetrations than 135%, but these higher penetrations levels are not assessed in this study.

As described in Section 2, threshold limits were evaluated for PV penetrations up to 135%. Limits may exist at higher penetrations and may need to be periodically reassessed as the existing PV and queued levels continue to change.

Figure 3.7 and 3.8 shows the results for all the distribution circuits in Electrical Cluster A. On each graph, the orange dashed lines represent the existing PV penetration, the smaller light-blue dashed lines represent the additional queued PV penetrations, if any. The shaded blue/white ranges represent the limit thresholds based on the PV penetrations range analyzed. The red horizontal line within this range marks the most likely estimate of the limit of PV penetration per criteria investigated based on linear approximation between the two PV penetrations defining the range.

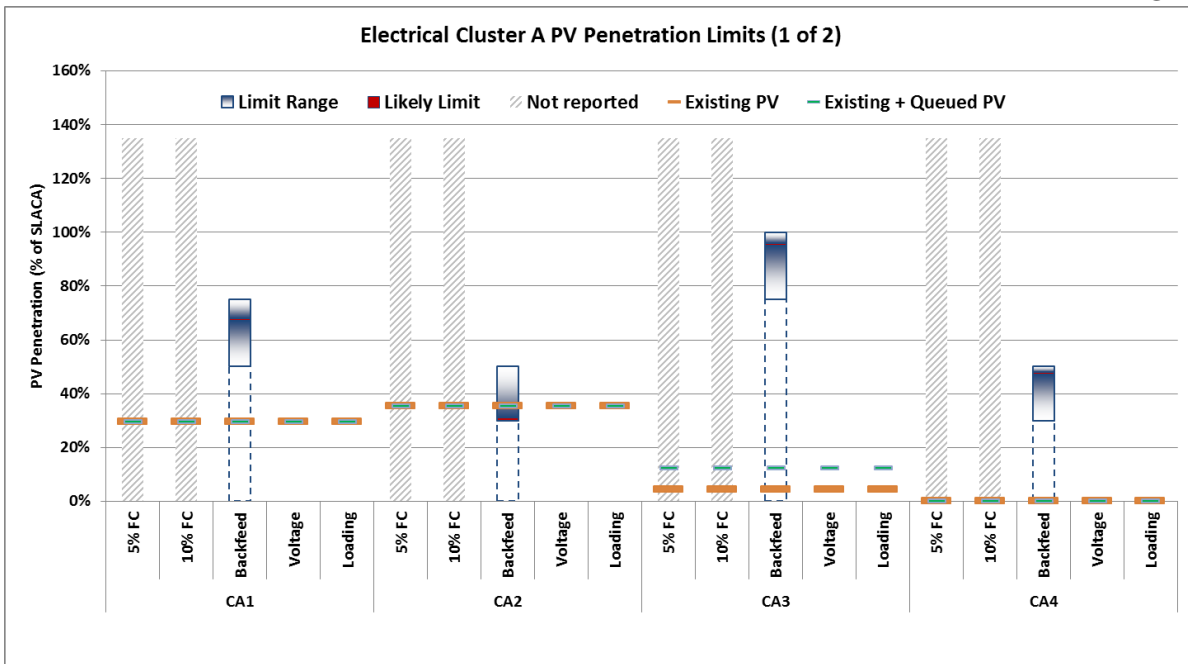

Figure 3.7. Electrical Cluster A Distribution Circuit Results (1 of 2).

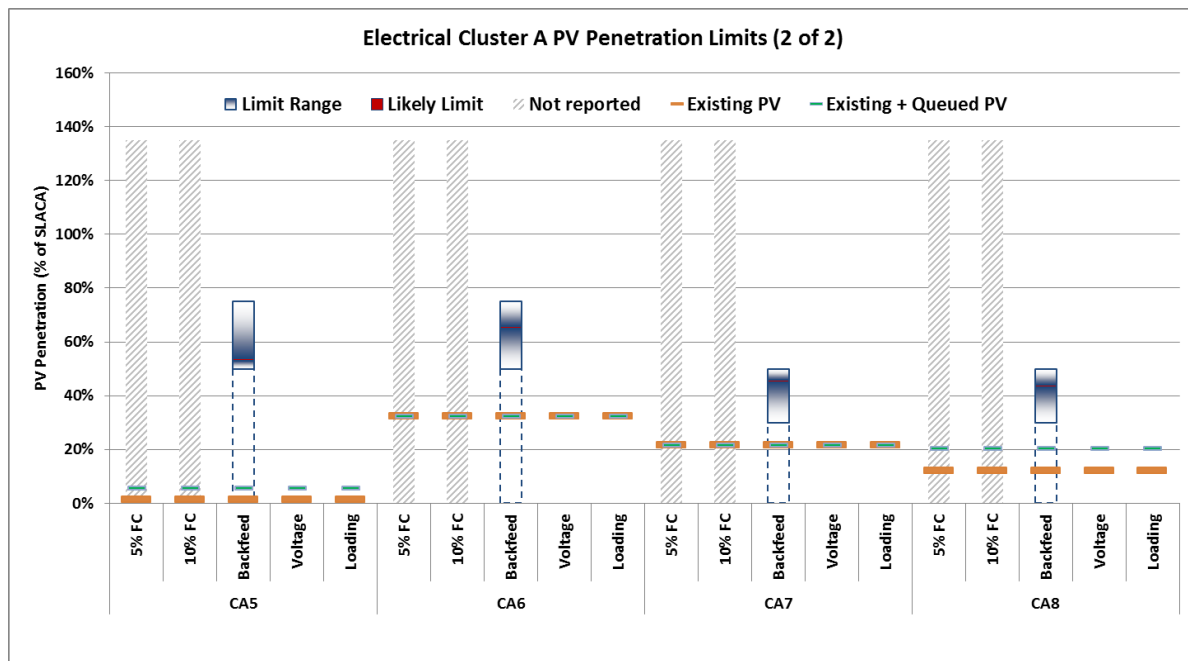

Figure 3.8. Electrical Cluster A Distribution Circuit Results (2 of 2).

Based on Figures 3.7 and 3.8, for all but 1 feeder, there are no existing backfeed conditions on the other circuits given current and queued PV values. However for CA 2, the dashed orange line is within the limit threshold and above the red line, which represents the likely PV penetration at which backfeed occurs. This indicates that there may be situations with the existing PV where

reverse power flow at the feeder head (start of the feeder) is possible on this circuit. This condition may result in voltage regulation problems on the feeder. Additionally, from Table 3.1, CA2 is connected to the same transformer (TA1) as circuit CA1. As such, PV penetration conditions on CA1 may also need to be observed for potential backfeed. Under backfeed conditions on CA2 (currently at 35% peak load penetration level), the reverse power flow from PV generation may feed directly into CA1 (currently at 29% peak penetration), assuming CA1 is not near a condition of backfeed. For CA1, its backfeed threshold based on analysis is around 50% and likely limit is near 65%. If the reverse power from CA2 does flow to CA1, measurements taken at the transformer (TA1) would only see a drop in overall load (on both CA1 and CA2) and not the reverse power flow due to PV. If both feeders had reverse power flow – or if the reverse power flow in CA2 is of a higher magnitude than the demand of circuit CA1 – then the transformer would see negative load due to reverse power flow and likely increased voltage problems on the circuits. Based on analysis, further PV penetration increases on circuit CA2 should be monitored along with CA1 conditions to prevent problems caused by reverse power flow and appropriate protection and mitigations measures may need to be considered. Up to the 135% PV penetration study scenario, no loading or voltage violations are observed on these circuits.

Table 3.4 and Figure 3.9 below show the results in tabular and graphical format for the transformers in Electrical Cluster A.

Table 3.4. Electrical Cluster A Transformer Results.

Transformer	Distribution Circuit	SLACA (kW)	Existing PV %	Existing + Queued PV %	Backfeed Limit	LTC Cycling Limit
TA1	CA1, CA2	4593	33.9%	33.9%	39%	N/R
TA2	CA3, CA4	3527	3.6%	10.4%	89%	N/R
TA3	CA5, CA6	6734	13.3%	16.0%	59%	N/R
TA4	CA7, CA8	4100	15.9%	20.7%	45%	N/R

3. N/R = Not Reported (insufficient data available)

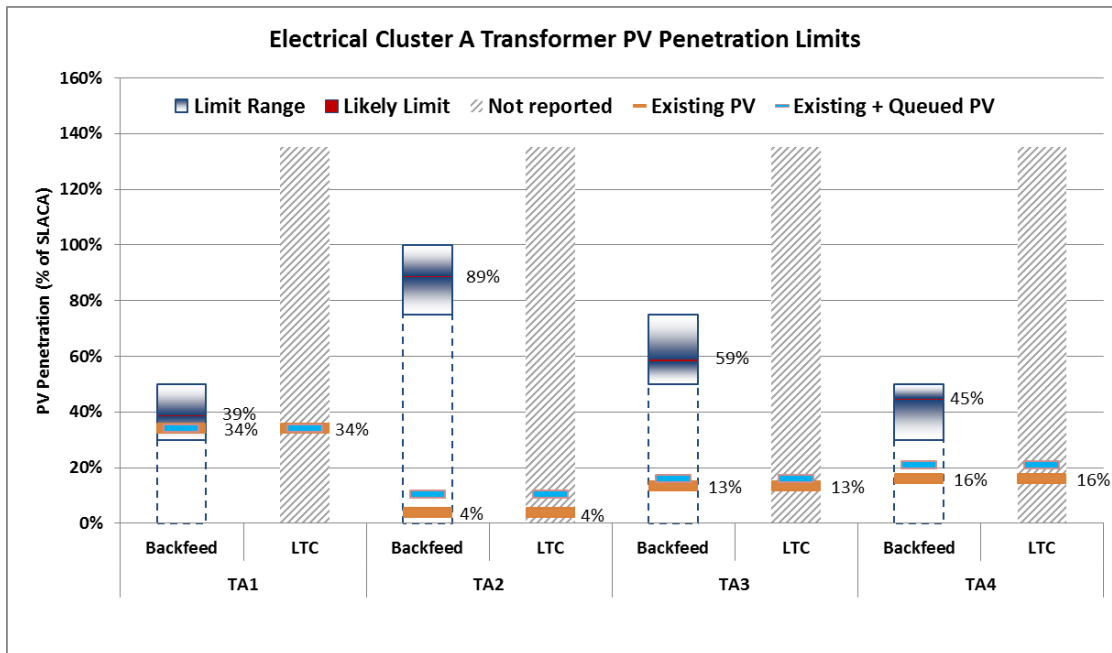

Figure 3.9. Electrical Cluster A Transformer Results.

Figure 3.9 shows that the backfeed threshold on the transformer TA1 has been reached given existing PV penetrations and is only narrowly below the estimated limit (approximately 5%). Reverse power flow may be likely on the transformer, especially on days with very low load (e.g. cool, sunny and breezy days), or if the PV penetration continues to increase on the circuits connected (CA1 and CA2). Additional LTC monitoring and some mitigation may therefore be necessary if more PV is to be accommodated and to prevent issues associated to reverse power flow. For the other transformers the backfeed thresholds are significantly more than the existing or queued PV penetrations, so no mitigations are immediately necessary. While no mitigations may be needed at this time, monitoring of the LTC position data for voltage regulation problems may be something to consider as these circuits have the potential for more PV penetration.

### 3.1.4 Electrical Cluster A Summary

The analysis presented in this report is intended to identify the technical limitations to future deployment of distributed PV generators on distribution circuits attached to the Electrical Cluster A sub-transmission line on Oahu. The distribution circuits' locations, loading and existing PV generation are presented, along with some peak and minimum load profiles. The analysis is split into 34 cases representing different combinations of load profile, installed PV capacity and PV generator output, with the intention that these are used to identify the point at which specific technical limits are exceeded.

Validation processes are performed for the transformers where data was available. In order to get the voltage at the transformers to be consistent with measured data, it is necessary to alter the LTC voltage set-point on one of the transformers (TA4) from the specified set-point. LTC position data is not available for three of the transformers (TA2, TA3, TA4), and LTC behavior is not validated for the fourth (TA1). With the caveat that the LTC voltage set-point is altered for the transformer TA4, the voltage behavior is validated for all transformers in the system.

The results show that one of the distribution circuits (CA2) has existing PV penetrations in excess of the backfeed limit, which suggests that it may already be experiencing reverse power flow at the head of the distribution circuit. The transformer TA1 also has an existing PV penetration very close to the backfeed limit which indicates that there is a strong possibility of reverse power flow occurring at this transformer if any future PV installations are considered. Monitoring and some mitigation measures are therefore necessary on these circuits in order to install further PV systems to address the potential of reverse power flow. Fault Current Rise results are not available at the time due to data limitations and should be addressed in the next analysis cycle..

### 3.2 Electrical Cluster B Evaluation Results

Electrical Cluster B represents a group of feeders serving a mixed base of customers ranging from residential, commercial and industrial in the Halawa Region. The Halawa Region is an ahupua'a, or a narrow wedge-shaped land section that runs North-East to South-West from the mountains to the harbor. The ahupua'a is indicative of the island's natural landscape and is a representative topology of many of the residential load centers on the islands. Thus, the area has good to moderate solar resource due to the valley and mountainous terrain. The analysis covered 7 feeders (CB1 through CB7) serving this community, representing medium length circuits (ranging from 1 mile to 1.5 miles) connected through 4 different transformers (TB1, TB2, TB3, TB4). Table 3.5 presents the distribution circuits included in the analysis, the transformers they are connected through, the SLACA (historical peak load) value and the existing and queued PV generation on the circuit. Table 3.6 below shows which data was available for the distribution circuits included in the study.

Table 3.5. Electrical Cluster B Distribution Circuit Data.

Distribution Circuit	Transformer	SLACA (kW)	Existing PV (kW)	Queued PV (kW)
CB1	TB1	4342	210	500
CB2	TB1	1898	586	0
CB3	TB2	3072	198	0
CB4	TB2	709	722	0
CB5	TB3	2470	0	0
CB6	TB4	3400	426	0
CB7	TB4	3920	926	0

Table 3.6. Electrical Cluster B Data Availability.

Distribution Circuit	SCADA/BMI	Feeder Model	Validation Data
CB1	Yes	Yes	Yes
CB2	Yes	Yes	Yes
CB3	Yes	Yes	Yes
CB4	Yes	Yes	Yes
CB5	No	Yes	No
CB6	Yes	Yes	No
CB7	Yes	Yes	No

Based on the data review, not all feeders have sufficient measured data to perform some of the analysis. In this case as a number of the feeders do not have LTC data for validation, the LTC position results will not be assessed at this time. For feeders with available data, if validation is successful, the following results will be provided.

- CB1 to CB4      All results are reported
- CB6 and CB7    Backfeed, Loading and Fault Current Rise results reported, no LTC or voltage data at this time to present
- CB5              Only Fault Current Rise reported, no load data at this time to present

### 3.2.1 Electrical Cluster B Load Profiles

Figure 3.10 shows the loading profiles in MW on the different feeders on Cluster A for a minimally loaded day (minimum load day). Figure 3.11 below shows feeder loadings on a highly loaded day (peak load day). The profiles are shown over the 10am to 4pm period of analysis for high penetration conditions.

Graphically, these feeders can be reviewed for highest loaded feeder, lowest loaded feeder, peaky load feeders and feeder with limited change between minimum and peak load conditions. For example, CB1 exhibits the highest loading amongst all the feeders during peak and minimum load conditions. CB2, CB3 and CB5 remain relatively steady in terms of loading for both peak and minimum conditions. CB6 and CB7 are connected to TB4 and exhibits peaky load during minimum load conditions. Knowing the range of low and high load swing between minimum load and peak load profiles helps to frame the potential variability impact of PV on the circuit.

From Table 3.5, the penetration of PV on the circuits can be compared. Two examples of observations are provided below that may be useful to inform analysis,

- For CB4, the percent penetration is over already over 100%, and it will be useful to identify what thresholds of exceedance this circuit is already exhibiting.
- For CB4, the percentage penetration (ratio of PV on circuit divided by SLACA) is already over 100% for a small historical peak load of 708kW, whereas for CB5, which has a high historical load of 2470kW, there currently is no PV installed. Better understanding of the types of customers on these circuits through rate classification and future smart meter data may help to provide insights on user adoption and usage patterns for high penetration circuit analysis.
- CB1 has 210kW of distributed PV with another 500kW in the queue. The resulting percent penetration of PV will be greater than 25% (ratio of PV divided by SLACA). Based on Electric Cluster A analysis, circuits with over 25% penetration showed the potential to backfeed and also required checking of the circuit's associated transformer and any other connected circuit. For CB1, the associated transformer and circuit would be TB1 and CB2, respectively. For CB2, the percent penetration of PV is already greater than 30%. Continued monitoring of CB1 and CB2 may be warranted especially with more PV being planned for CB1.



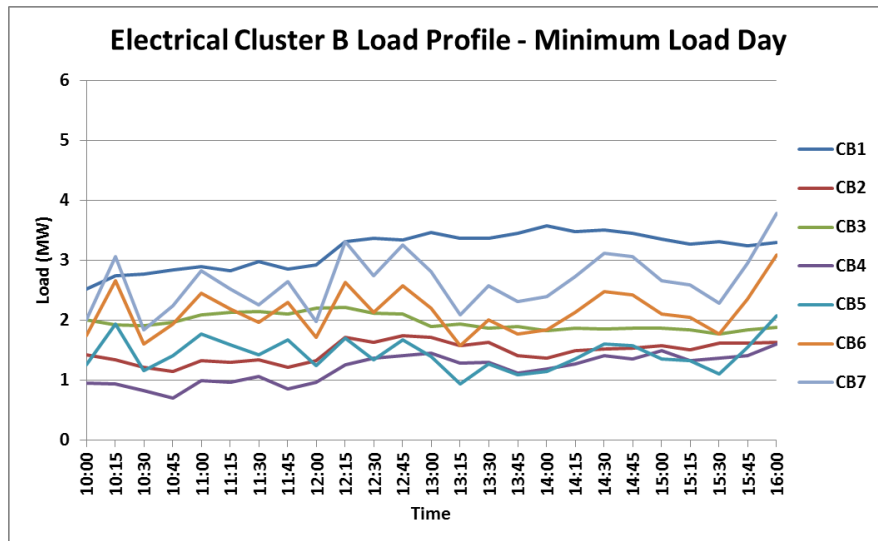

Figure 3.10. Electrical Cluster B Minimum Load Profiles.

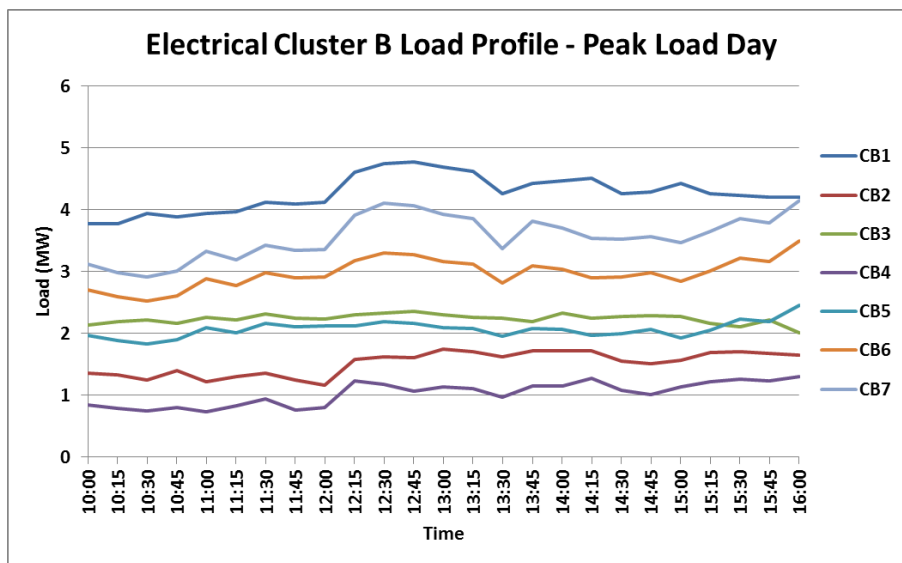

Figure 3.11. Electrical Cluster B Peak Load Profiles.

### 3.2.2 Electrical Cluster B Validation

For validation purposes, only single time instance measurements are available for the transformers TB1 and TB2, so the validation is performed only in these cases, as opposed to the longer load profile shown in Section 3.1.2. This is another advantage of using a consistent approach and reporting format to be able to consistently compare analysis results as the validation data and the input information may vary from circuit to circuit and regions.

The same analysis process is followed as for Electrical Cluster A. For example, a measured value is used in the model and set to be within 1% of the measured value. Voltage data obtained from the model is checked for consistency with the measured value. The results are shown in Tables 3.7 and 3.8.

Table 3.7. Transformer TB1 Validation.

Transformer TB1: Instance 1 February 28th 2013 - 14:28	Measured Value	Modeled Value	Validated
<b>TB1 Power (MVA)</b>	5.16	5.14	Yes
<b>TB1 Power Factor</b>	0.959	0.962	Yes
<b>TB1 Voltage</b>	122.5	122.0	Yes
<b>TB1 LTC Position</b>	1(L)	2(L)	Yes

Table 3.8. Transformer TB2 Validation.

Transformer TB2: Instance 1 February 28th 2013 - 14:42	Measured Value	Modeled Value	Validated
<b>TB2 Power (MVA)</b>	2.88	2.89	Yes
<b>TB2 Power Factor</b>	0.991	0.991	Yes
<b>TB2 Voltage</b>	121.67	122.08	Yes
<b>TB2 LTC Position</b>	4(L)	5(L)	Yes

For TB1 and TB2, results summarized in Tables 3.7 and 3.8 show the transform apparent power in units of mega volt-ampere (MVA), power factor, voltage and LTC position. Power factor is a ratio of the power (real power to perform work) to the apparent power (product of the current and voltage of the circuit). Power factor is a number between -1 and 1 and provides an indicator of the current draw. The lower the power factor, the more current the load draws. Higher currents on the circuits result in higher losses, larger wires and higher current equipment on the distribution system. For electrical systems, maintaining unity power factor (PF =1) is desired to minimize costs to customers due to losses and cost of larger equipment. A negative power factor gives an indication that the load may be generating power and back flowing toward the direction of the generator source.

Validation result show that the modeled voltage is within the 0.75V of the measured value requirement for voltage and the modeled LTC position is within one step of the measured value. This step validates the consistency of the SynerGEE model based on the real transformer information both in terms of voltage and LTC position. Therefore, both the voltage results and LTC position results can be validated and will be reported for purposes of the analysis.

### 3.2.3 Electrical Cluster B Results

Table 3.9 and Figure 3.12 and Figure 3.13 summarize the results for the Electrical Cluster B distribution circuits. Table 3.9 tabularizes the circuit conditions and PV penetration levels provided at the time of the study, along with fault current limits and voltage and loading thresholds assessed.

As described in Section 2, threshold limits were evaluated for PV penetrations up to 135%. Limits may exist at higher penetration and may need to be periodically reassessed as the existing PV and queued levels continue to change.

Table 3.9. Electrical Cluster B Distribution Circuit Results.

Distribution Circuit	SLACA (kW)	Existing PV %	Existing + Queued PV %	5% Fault Current Limit	10% Fault Current Limit	Voltage Limit up to 135%	Loading Limit up to 135%
CB1	4342	16.4%	27.9%	26%	59%	None	None
CB2	1898	30.6%	30.6%	27%	61%	None	None
CB3	3072	6.5%	6.5%	44%	104%	None	None
CB4	709	101.3%	101.3%	47%	108%	None	None
CB5	2470	0%	0%	79%	None	N/R	N/R
CB6	3400	12.5%	12.5%	31%	62%	N/R	None
CB7	3920	23.2%	23.2%	30%	62%	N/R	None

4. N/R = Not Reported (data not presently available)
5. Where limit is given as 'None', this should be understood as 'no limit was found up to PV penetration of 135%'  
Limits may exist at higher penetrations than 135%, but these higher penetrations are not assessed in this study.

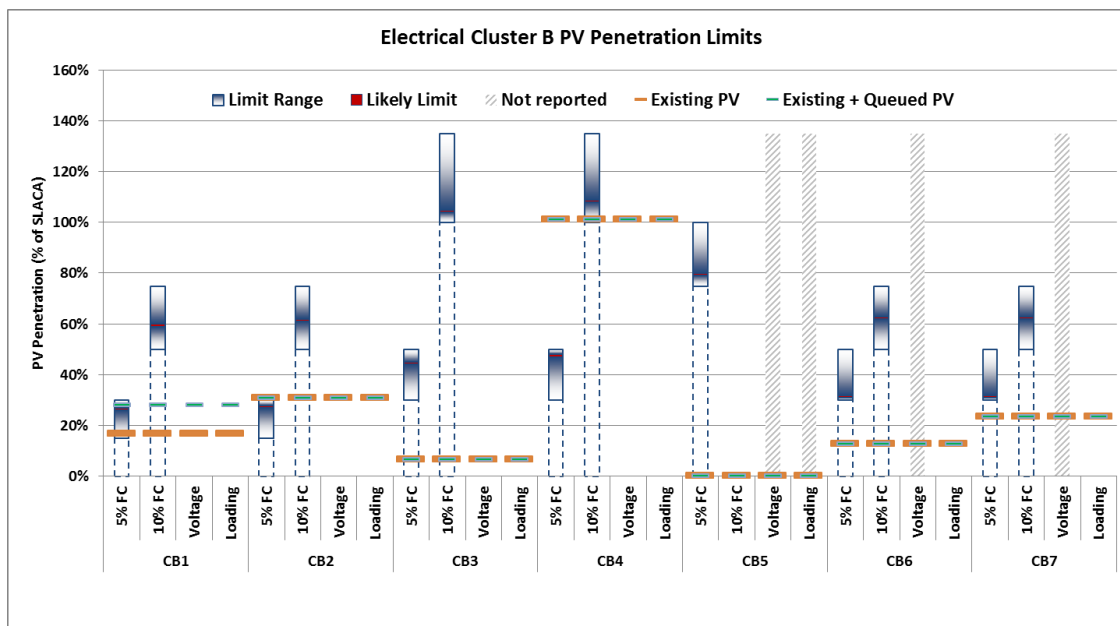

Figure 3.12. Electrical Cluster B Distribution Circuit Results.

Figure 3.12 shows the results for the seven distribution circuits in the cluster. The orange and blue dashed lines represent existing and queued PV levels consistent with Electrical Cluster A descriptions. Points of interest in the results include:

- On CB1 the queued PV penetration (blue dashed line) is above the limit for 5% Fault Current Rise;
- On CB2 the existing PV penetration (orange dashed line) is above the limit for 5% Fault Current Rise;
- On CB4 the existing PV penetration is significantly above the limit for 5% Fault Current Rise, and very close to or in excess of the limits for 10% Fault Current Rise and potential backfeed.

CB4 may already be seeing reverse power flow on some occasions at the head of the circuit, and therefore mitigation measures may be necessary in order to successfully add additional PV. For the feeders where the 5% or 10% rise in Fault Current criteria are exceeded (CB1, CB2 and CB4), additional checks on equipment are necessary to investigate whether the circuit breaker current ratings are exceeded. Inadequate fault current protection may lead to protection coordination issues on the circuit and can lead to equipment damage. The other circuits are not exhibiting these concerns as the PV penetrations are currently well below the thresholds identified in the analysis (denoted with the limit range).

Table 3.10 and Figure 3.13 summarize results for the transformers of Electrical Cluster B. Based on results depicted in Figure 3.13, existing PV penetration levels are well within the backfeed and LTC thresholds on the transformers. At present PV penetration levels, the transformers are not close to or exceeding the backfeed or LTC cycling limit. As penetration levels continue to increase for TB1 up toward 50% and TB2 up toward 30%, as identified by the lower end of the limit range bar, backfeed or LTC conditions need to be reviewed. TB3 and TB4 validation data was not completed and therefore not reported here, however once data is available to validate, similar analysis can be completed and immediately added to these results to track the changes on Cluster B.

Table 3.10. Electrical Cluster B Transformer Results.

Transformer	Feeders	SLACA (kW)	Existing PV %	Existing + Queued PV %	Backfeed Limit	LTC Cycling Limit
<b>TB1</b>	CB1, CB2	6240	20.7%	28.9%	65%	50%
<b>TB2</b>	CB3, CB4	3781	24.2%	24.2%	66%	49%
<b>TB3</b>	CB5, CB6	7320	18.2%	18.2%	47%	N/R

6. N/R = Not Reported (insufficient data available)

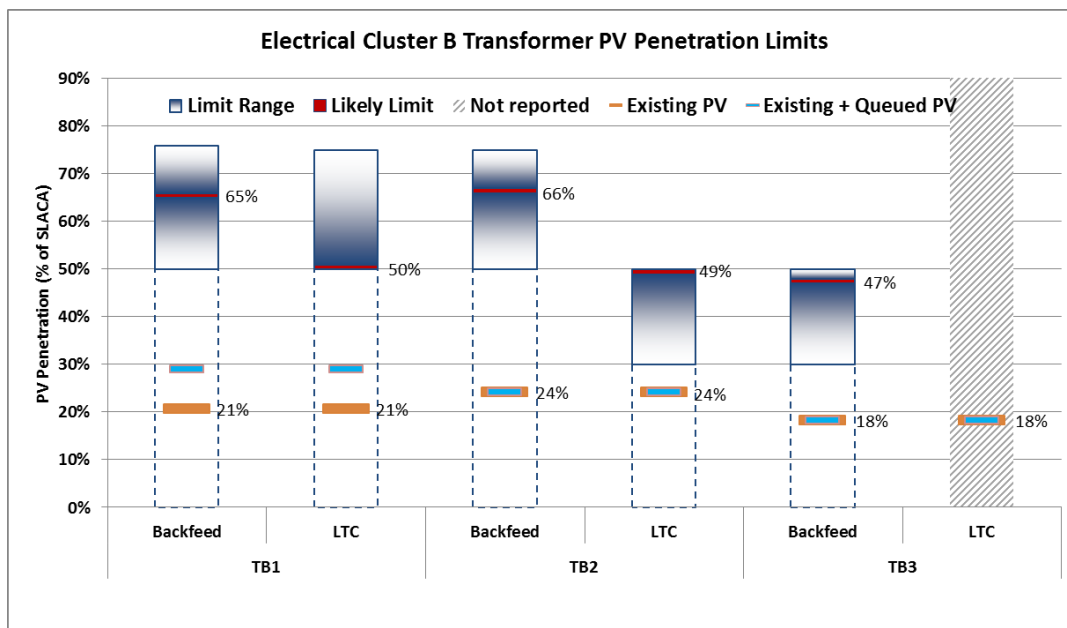

Figure 3.13. Electrical Cluster B Transformer Results.

### 3.2.4 Electrical Cluster B Summary

The analysis presented in this report is intended to identify the technical limitations to future deployment of distributed PV generators on distribution circuits connected to the Electrical Cluster B sub-transmission feeders on Oahu. Validation processes were performed for the transformers where data was available and identified data needs to inform future monitoring. For this evaluation, only single time-steps were used for validation on the TB1 and TB2 transformers. Model results for voltage and LTC position characteristics were successfully validated and reported.

The results show that two of the distribution circuits (CB2 and CB4) have existing PV penetrations in excess of the 5% Fault Current Rise limit. This means that the circuit breaker ratings should be checked to ensure that the total available fault current on these circuits does not exceed the ratings. This is also true for the queued PV penetration on CB1. On CB4, the existing PV penetration is also in excess of the backfeed limit, which indicates that reverse power flow may be occurring at the head of the distribution circuit, and therefore some mitigation measures may be necessary to facilitate increased PV penetration on this circuit without causing problems due to reverse power flow, as described in section 2.2. At the transformer level, none of the existing or queued PV penetrations are close to the identified limiting penetrations, and therefore no mitigation measures are immediately necessary to facilitate increased PV penetrations without causing problems at the transformers.

### 3.3 Electrical Cluster C Evaluation Results

Electrical Cluster C represents a group of feeders serving commercial and residential loads in the West Region. The West Region is less densely populated compared to Electrical Cluster A and B, has more land open space land zoned for agriculture. This area has good solar resource especially at the southern end of the region but has some foothills near residential communities. The analysis covered 5 feeders (CC1 through CC5) serving this community, representing medium to long length circuits (ranging greater than 1.5 miles) connected through 4 different transformers (TC1, TC2, TC3, TC4). Table 3.11 presents the distribution circuits included in the analysis, the transformers they are connected through, the SLACA (historical peak load) value and the existing and queued PV generation on the circuit. Table 3.12 below shows which data was available for the distribution circuits included in the study.

Table 3.11. Electrical Cluster C Distribution Circuit Data.

Distribution Circuit	Transformer	SLACA (kW)	Existing PV (kW)	Queued PV (kW)
CC1	TC1	6200	173.19	245
CC2	TC2	3850	726.51	300
CC3	TC3	3787	671.383	2950
CC4	TC3	2143	471.07	3050
CC5	TC4	5300	1051.56	1750

Table 3.12. Electrical Cluster C Data Availability.

Distribution Circuit	SCADA/BMI	Feeder Model	Validation Data
CC1	Yes	Yes	Yes*

CC2	Yes	Yes	Yes*
CC3	Yes	Yes	Yes*
CC4	Yes	Yes	Yes*
CC5	Yes	Yes	Yes*

\*: LTC position data not available, only voltage data is available for validation

Based on the data review, not all feeders have sufficient measured data to perform some of the analysis. In this case, the LTC data was not available based on measurements in the field, thus the LTC position results will not be reported at this time. While LTC position is an important indicator for high penetration PV impacts, it is not the sole indicator. As noted in Cluster B analysis, the fault current rise conditions may be a more limiting condition due to circuit protection device capabilities. For Cluster C, a significant amount of the evaluations can still be performed with valuable insights to be gained even without the LTC position data. Through this process, the condition has also been identified for further utility review and prioritized for LTC monitoring equipment so condition can be assessed in future analysis cycles. For feeders with available data, if validation is successful, the following results will be provided.

- All circuits      Backfeed, Voltage, Loading and Fault Current Rise results will be reported

Based on Table 3.11, preliminary review indicates that at existing levels, CC5 is approaching 20% penetration, however to accommodate the queued PV, proactive modeling of the circuits to identify threshold and likely exceedance limits on high penetration criteria identified in Table 2.1 is essential. With queued PV, CC3 and CC4, both connected at TC3 will have penetration percentages over 100%. As noted in Cluster A analysis, the condition of backfeed on both circuits and at the transformer (TC3) will require careful review and mitigation. CC5 will also be approaching 50% penetration and based on Cluster B, this was a condition of fault current exceedance on some of the circuits.

### 3.3.1 Electrical Cluster C Load Profiles

Figure 3.14 shows the loading profiles in MW on the different feeders on Cluster C for a minimally loaded day (minimum load day). Figure 3.15 shows feeder loadings on a highly loaded day (peak load day). The profiles are shown over the 10am to 4pm period of analysis for high penetration conditions.

Graphically, these feeders can be reviewed for highest loaded feeder, lowest loaded feeder, peaky load feeders and feeder with limited change between minimum and peak load conditions. For example, CC1 exhibits the highest loading (at or above 4 MW) amongst all the feeders during peak and minimum load conditions. CC1 and CC4 remain relatively steady in terms of loading for both peak and minimum conditions.

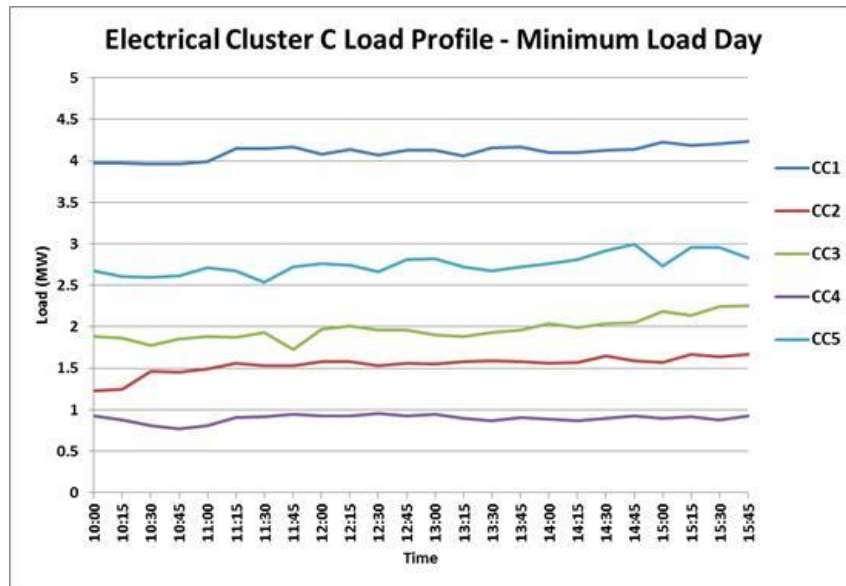

Figure 3.14. Electrical Cluster C Minimum Load Profiles.

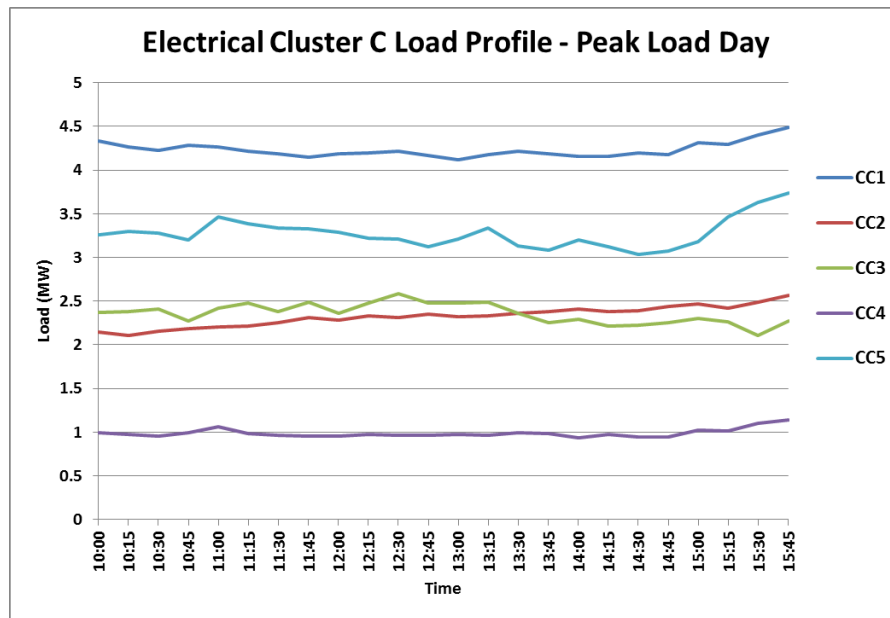

Figure 3.15. Electrical Cluster C Peak Load Profiles.

### 3.3.2 Electrical Cluster C Validation

The validation data for four of the transformers in the model – TC1, TC2, TC3 and TC4– are shown in Tables 3.13 to 3.20. Two different measured daytime instances are used for validation (April 8<sup>th</sup> and April 23<sup>rd</sup>). The values measured and obtained from the model are shown. In some instances, the LTC set points had to be adjusted for the conditions to be validated, similar to Cluster A.

Table 3.13. Transformer TC1 Instance 1 Validation.

Transformer TC1: Instance 1 April 8 <sup>th</sup> 2012 - 12:03	Measured Value	Modeled Value (Original Settings)	Modeled Value (LTC setpoint adjusted)	Validated
<b>TC1 1 MVA</b>	4.85	4.85	4.87	Yes
<b>TC1 Power Factor</b>	0.9	0.9	0.9	Yes
<b>TC1 Voltage</b>	122.18	124.39	122.79	Yes
<b>TC1 LTC Position</b>	N/A	N/A	N/A	No

Table 3.14 Transformer TC1 Instance 2 Validation

Transformer TC1: Instance 2 April 23 <sup>rd</sup> 2012 - 12:34	Measured Value	Modeled Value (Original Settings)	Modeled Value (LTC setpoint adjusted)	Validated
<b>TC1 MVA</b>	4.600	4.618	4.597	Yes
<b>TC1 Power Factor</b>	0.9	0.9	0.9	Yes
<b>TC1 Voltage</b>	121.51	124.62	122.25	Yes
<b>TC1 LTC Position</b>	N/A	N/A	N/A	No

Table 3.15. Transformer TC2 Instance 1 Validation.

Transformer TC2: Instance 1 March 16 <sup>th</sup> 2012 - 12:01	Measured Value	Modeled Value (Original Settings)	Modeled Value (LTC setpoint adjusted)	Validated
<b>TC2 MVA</b>	3.24	3.238	3.242	Yes
<b>TC2 Power Factor</b>	0.9	0.9	0.9	Yes
<b>TC2 Voltage</b>	122.14	124.87	121.74	Yes
<b>TC2 LTC Position</b>	N/A	N/A	N/A	No

Table 3.16. Transformer TC2 Instance 2 Validation.

Transformer TC2: Instance 2 March 28 <sup>th</sup> 2012 - 14:18	Measured Value	Modeled Value (Original Settings)	Modeled Value (LTC setpoint adjusted)	Validated
<b>TC2 MVA</b>	3.042	3.042	3.044	Yes
<b>TC2 Power Factor</b>	0.9	0.9	0.9	Yes
<b>TC2 Voltage</b>	122.06	125.04	121.91	Yes
<b>TC2 LTC Position</b>	N/A	N/A	N/A	No

Table 3.17. Transformer TC3 Instance 1 Validation.

Transformer TC3: Instance 1 March 16 <sup>th</sup> 2012 - 12:01	Measured Value	Modeled Value (Original Settings)	Modeled Value (LTC setpoint adjusted)	Validated
<b>TC3 MVA</b>	3.477	3.466	3.478	Yes



<b>TC3 Power Factor</b>	0.9	0.9	0.9	Yes
<b>TC3 Voltage</b>	122.281	123.79	122.19	Yes
<b>TC3 LTC Position</b>	N/A	N/A	N/A	No

Table 3.18. Transformer TC3 Instance 2 Validation.

Transformer TC3: Instance 2 March 28 <sup>th</sup> 2012 – 14:18	Measured Value	Modeled Value (Original Settings)	Modeled Value (LTC setpoint adjusted)	Validated
<b>TC3 MVA</b>	3.434	3.436	3.435	Yes
<b>TC3 Power Factor</b>	0.9	0.9	0.9	Yes
<b>TC3 Voltage</b>	121.972	123.81	122.22	Yes
<b>TC3 LTC Position</b>	N/A	N/A	N/A	No

Table 3.19. Transformer TC4 Instance 1 Validation.

Transformer TC4: Instance 1 March 16 <sup>th</sup> 2012 – 12:01	Measured Value	Modeled Value (Original Settings)	Modeled Value (LTC setpoint adjusted)	Validated
<b>TC4 MVA</b>	2.633	2.631	2.632	Yes
<b>TC4 Power Factor</b>	0.9	0.9	0.9	Yes
<b>TC4 Voltage</b>	121.35	123.18	120.83	Yes
<b>TC4 LTC Position</b>	N/A	N/A	N/A	No

Table 3.20. Transformer TC4 Instance 2 Validation.

Transformer TC4: Instance 2 March 28 <sup>th</sup> 2012 – 14:18	Measured Value	Modeled Value (Original Settings)	Modeled Value (LTC setpoint adjusted)	Validated
<b>TC4 MVA</b>	2.661	2.662	2.657	Yes
<b>TC4 Power Factor</b>	0.9	0.9	0.9	Yes
<b>TC4 Voltage</b>	121.004	123.24	120.9	Yes
<b>TC4 LTC Position</b>	N/A	N/A	N/A	No

In all instances, summaries show that the voltage is not within the required band-width of 0.75V using the original LTC voltage set-point of 122V. In order to shift the voltage down towards the measured value, the LTC set-point is changed to 120V, and with this setting the tables show that the voltage is within 0.75V of the measured value at both time-steps. Therefore, with the caveat that the LTC voltage set-point has been changed from the given value, these transformers can be considered validated for voltage. Data on LTC position was not available at this time, so these results are not reported for these transformers.

### 3.3.3 Electrical Cluster C Results

Table 3.21 and Figure 3.16 show the results for the five distribution circuits in Electrical Cluster C. There are several areas of interest to point out. Based on existing PV installations, none of the

circuits are in excess of the identified thresholds and exceedance limits. However, at queued PV penetrations, circuits CC3, CC4 and CC5 are in excess of Fault Current Rise and Backfeed limits, indicating that several problems are likely to occur if all of the queued PV is installed. Note how much CC4 is in exceedance of the likely backfeed and fault current limits as the queued level is even beyond the upper 135% of the analysis threshold. Based on these new thresholds and exceedance limits, the queued projects may need to be reassessed. Issues of concern include:

- If the Backfeed limit is exceeded, reverse power flow may occur at the feeder head may cause problems for voltage regulation on the feeder and some mitigation measures may be necessary.
- Where the Fault Current Rise limits are exceeded, the available fault current should be checked to ensure that it does not exceed the current rating on the circuit breakers.

As there seems to be interest in more PV installations based on the larger queued projects and availability of land in this region, additional monitoring and timely reassessment of SLACA numbers and circuit LTC performance is recommended.

Table 3.21 Electrical Cluster C Distribution Circuit Results

Distribution Circuit	SLACA (kW)	Existing PV %	Existing + Queued PV %	5% Fault Current Limit	10% Fault Current Limit	Voltage Limit up to 135%	Loading Limit up to 135%
<b>CC1</b>	6200	10.8%	14.8%	N/A	N/A	122%	None
<b>CC2</b>	3850	9.3%	17.1%	47%	99%	None	None
<b>CC3</b>	3787	13.0%	90.9%	38%	89%	None	None
<b>CC4</b>	2143	22.0%	188.0%	42%	96%	None	None
<b>CC5</b>	5300	19.8%	52.9%	33%	74%	None	127%

7. N/A = Not Available (analysis will not be completed within the timeframe of this project)
8. Where limit is given as 'None', this should be understood as 'no limit was found up to PV penetration of 135%' Limits may exist at higher penetrations than 135%, but these higher penetrations are not assessed in this study

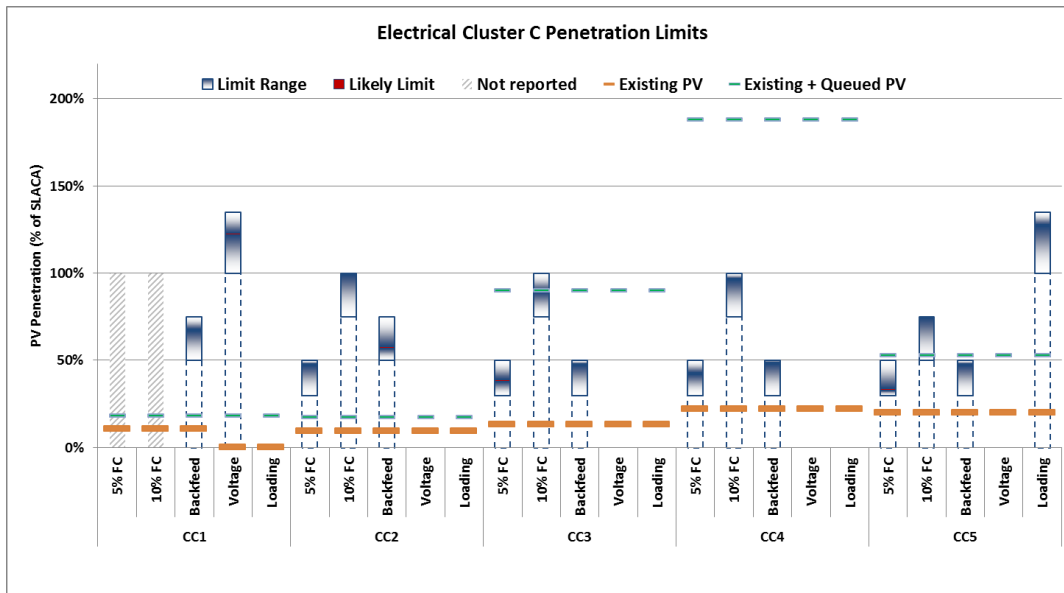

Figure 3.16. Electrical Cluster C Distribution Circuit Results.

Table 3.22 and Figure 3.17 summarize the results for the transformers in Cluster C. Existing and queued penetrations on the transformers are within the thresholds identified for transformers TC1 and TC2. For transformers TC3 and TC4 the existing PV penetrations are also within the threshold limits, but if all the queued PV on the circuits are included, reverse power flow at the transformer is likely given current circuit configurations and will cause problems for voltage regulation equipment. Managing levels within the Backfeed and LTC threshold limits would be an initial recommendation to minimize unforeseen impacts on the system and would allow for further monitoring as penetration levels increase. For TC3, for example the backfeed threshold is more limiting than the LTC threshold. Initial Backfeed lower threshold range is around 30% penetration with likely exceedance limit at 47% (red line) where the LTC exceedance limit is at 76%. Queued levels on TC3 would push the penetration to 125% which is nearly 50% over the exceedance limit. These values provide insight on what may be practical given upgrade costs versus impact on system reliability and can be used to periodically track penetration.

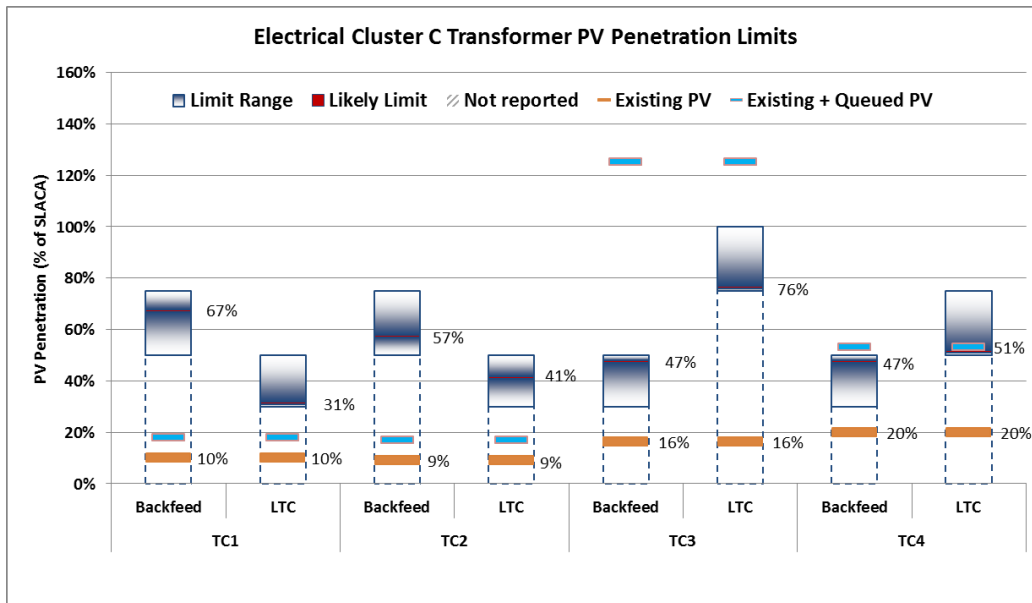

Figure 3.17. Electrical Cluster C Transformer Results.

Table 3.22. Electrical Cluster Transformer Results.

Transformer	Distribution Circuit	SLACA (kW)	Existing PV %	Existing + Queued PV %	Backfeed Limit	LTC Cycling Limit
TC1	CC1	6200	10.8%	14.8%	67%	31%
TC2	CC2	3850	9.3%	17.1%	57%	41%
TC3	CC3, CC4	5930	16.3%	125%	47%	76%
TC4	CC5	5300	19.8%	52.9%	47%	51%

9. N/R = Not Reported (Requires additional information, not within timeframe of this project)

### 3.3.4 Electrical Cluster C Summary

For Cluster C, validation was performed based on 2 time instances. Validation indicated that additional monitoring for LTC position information is needed as it was necessary to alter the LTC voltage set-point on all the transformers in order to achieve validation of voltage conditions. LTC position data is unavailable for any of the transformers in this study, so this aspect has not been validated, and any limitations on increased PV penetration due to LTC cycling are not identified in this analysis. Additionally, more frequent analysis may also be needed given the great interest in PV development in the region, as indicated by the queue.

The analysis provided threshold ranges and exceedance limits based on the Technical Criteria established for high penetration PV evaluation. At present levels of PV, results showed that all circuits are within threshold and exceedance levels. The queued PV penetrations on the system are very high, and if all of the queued PV on distribution circuits (CC3, CC4 and CC5) is implemented, Fault Current Rise and Backfeed limits will be exceeded. If Fault Current Rise limits are exceeded, further analysis is necessary to check that the circuit breaker current rating is not exceeded by the available fault current. If this rating is exceeded, the circuit breaker would have to be upgraded to facilitate increased PV penetration. If the Backfeed limit is exceeded, mitigation measures may be

required to ensure that reverse power flow does not cause problems for voltage regulation equipment, which can result in unstable voltages on the distribution circuit. Transformers TC3 and TC4 would also be likely to see reverse power flow if all of this queued PV is installed.

Mitigation measures including upgrades to facilitate all these PV systems will warrant a further level of evaluation to assess the economic and reliability impact for the need to increase PV to these levels at these locations. This level of review is beyond the Proactive analysis however the hope is that these thresholds on circuits, once determined and assessed in a timely fashion can be used to inform decisions.

### 3.4 Applying Results to Quantify Remaining Capacity on Feeders

Results of detailed feeder and cluster analysis in the previous sections are summarized in Table 3.23. Instead of percentage limits, the % Backfeed Limit and % LTC Cycling Limit values are converted back into kW of remaining capacity to provide perspective on the potential of more PV installations. This remaining capacity however is only a projection and may be further constrained depending on system conditions (due to changing on-line generation) and dynamic analysis such as contingency considerations in Section 4. These steady-state runs provide perspective on the thresholds at the distribution level which can now be consistently aggregated up to the system level so distribution level impacts may be included in system level assessments.

As shown in Table 3.23, the simulation based limits for each of the Electrical Clusters is presented in kW. Results at the Transformer level provide perspective on the distribution impacts due to high penetration PV. For example, for Cluster B – TB1 in Table 3.23, the Backfeed Limit is 4056 kW and the LTC Cycling Limit is 3120 kW. These kW values correspond to the % values presented in Figure 3.13 and Table 3.10 (65% Backfeed Limit equates to 4056 kW and 50% LTC Cycling Limit equates to 3120 kW). The remaining capacity for Backfeed and LTC are calculated by taking the difference of these limits and the Existing PV in kW. For Cluster B – TB1, the Remaining Capacity by Backfeed is 2764 kW which is the difference between 4056 kW (Backfeed Limit) and 1292 kW (Existing PV). For Cluster B – TB1, the Remaining Capacity by LTC is 1828 kW which is the difference between 3120 kW (LTC Cycling Limit) and 1292 kW (Existing PV).

The lower of the Backfeed or LTC is chosen as the Remaining Transformer Level Capacity and is shown in 'red' in Table 3.23. This value can then be used to assess new installations that are in the Existing + Queued (shown in 'BLUE' in Table 3.23) column. Per the evaluation, for Cluster B and Cluster C, a number of the Transformers within each cluster will exceed remaining capacity levels if all queued PV is installed.

Table 3.23. Summary of Cluster A, B and C Results by Transformer Limits.

Electrical Cluster and Transformer	Existing PV (kW)	Existing + Queued PV (kW)*	Backfeed Limit (kW)	Remaining Capacity by Backfeed (kW)	LTC Cycling Limit (kW)	Remaining Capacity by LTC (kW)	Remaining Transformer Level Capacity (kW)**
Cluster A - TA1	1557	1557	1791	234	N/R	N/R	234
Cluster A - TA2	127	367	3139	3012	N/R	N/R	3012

<b>Cluster A - TA3</b>	896	1077	3973	3077	N/R	N/R	3077
<b>Cluster A - TA4</b>	652	849	1845	1193	N/R	N/R	1193
<b>Cluster B - TB1</b>	1292	1803	4056	2764	3120	1828	1828
<b>Cluster B - TB2</b>	915	915	2495	1580	1853	938	938
<b>Cluster B - TB3</b>	1332	1332	3440	2108	N/R	N/R	2108
<b>Cluster C - TC1</b>	670	918	4154	3484	1922	1252	1252
<b>Cluster C - TC2</b>	358	658	2195	1836	1579	1220	1220
<b>Cluster C - TC3</b>	967	7413	2787	1821	4507	3540	1821
<b>Cluster C - TC4</b>	1049	2804	2491	1442	2703	1654	1442

\* PV penetration levels at the time of analysis

\*\* Remaining capacity value listed may be further constrained by system conditions and are presented to offer perspective versus an absolute number.

Table 3.24 shows each of the Clusters’ total Existing PV, Queued PV and Total Remaining Capacity. Results at the Cluster level provide perspective on likely potential for system impacts due to high penetration PV. The Total Remaining Capacity for the Cluster is calculated by adding the individual Remaining Transformer Level Capacities shown in Table 3.23. Only the Transformer Remaining Capacity is additively shown and compared with Existing + Queued PV. This offers a quick way to gauge penetration levels at the Cluster level and potential to impact the system. Assessments however still need to be conducted based on the individual Transformer level thresholds and individual Transformers penetrations due to PV.

Table 3.24. Existing PV, Queued PV and Remaining Transformer Level Capacity for Cluster A, B & C.

	Existing PV (kW)	Existing + Queued PV (kW)*	Total Remaining Capacity for Cluster (kW)**	Grid Impact Factor (GIF)
<b>Cluster A Total</b>	3232	3850	7517	0.49
<b>Cluster B Total</b>	3539	4051	4874	0.16
<b>Cluster C Total</b>	3044	11793	5735	-1.05

The Grid Impact Factor (GIF) provides a gauge of impact to the grid. Positive GIF has more available capacity for DG installations. Large negative GIF indicates constrained and likely extensive studies and mitigations. GIF close to 0 indicates the Cluster should be closely monitored as it is approaching a threshold of exceedance identified in the study.

- For Cluster A, all transformer levels are within the remaining threshold values based only on the Backfeed Limit threshold as LTC data was not available for this cluster. Cluster A – TA1 is getting close to its transformer’s Remaining Capacity of 234 kW. While the Existing + Queued

PV values for the other transformers (TA2 through TA4) are a little more than half of the remaining capacity, LTC monitoring is advised to be implemented so the backfeed threshold can also be assessed in a timely basis. Based on other cluster evaluations, the LTC threshold can be more limiting than backfeed conditions due to the physical characteristics of the feeder (e.g. length, conductor size, type of loads). From a system impact perspective, at the current levels assessed, this cluster has relatively low impact with a GIF = 0.49. However as noted above, LTC monitoring is recommended to assess limits based on these thresholds.

- For Cluster B, the results on all transformers (TB1 to TB 3) indicate that there is remaining capacity to consider all the Existing + Queued PV assessed within the timing of this analysis using June 2013 data. Some mitigation measures related to backfeed may need to be considered and evaluated by the utility as demand to install PV (shown as 4051 kW) is approaching the 4874 kW threshold given the increase in the queue. From a system impact perspective, at the current levels assessed, this cluster has moderate impact with a GIF = 0.16 which means more routine monitoring at the feeders.
- For Cluster C, results show that the demand for PV in the queue will surpass the existing infrastructure with a GIF = -1.05. Specifically at Cluster C – TA3, the Existing + Queued PV is 7413 kW and the Remaining Transformer Level Capacity is 1821 kW from Table 3.23. At the distribution level, as the feeders are interconnected by their transforms and transformer loads may also be switched over to other feeders for maintenance or switching conditions, protection devices that sense backfeed and review of circuit switching schemes need to be closely reviewed by Distribution Planning. Given the current queue at the time of the study (June 2013 data), demand for PV has increased on all Transformers from an aggregated installed total of 3044 kW to 11,793 kW or 8749 kW of new PV requested to be installed. Total Remaining Capacity for Cluster is estimated at 5735 kW from Table 3.24. If approximately 5000 kW of the 5735 kW is installed (pending other switching and system considerations which may reduce this value), there are still over 3700 kW (11,793 – 3044 kW (existing) – 5000 kW (assumed queued and installed)) more to consider in the queue that is beyond the existing infrastructure capabilities. Assuming 3 kW typical sized installations for a home on Oahu, this equates to approximately 1666 customers added with PV and 1200 customer in excess of the limit. Assuming 500 kW Feed-in-Tariff installations, this would equate to approximately 10 projects interconnected and 6 projects in exceedence. Customers and developers need to work with the utility to understand interconnection needs, the cost implications and determine the cost effectiveness of further additions to the feeders and any mitigation pursued.

Such analysis provides perspective on the challenges utility planners face. The evaluation methodology also provides a transparent process to further investigate appropriate upgrades and mitigation strategies with customers and developers. For some transformers and existing infrastructure, the costs may surpass the need and the sooner those instances can be identified, the more informed the customer and developers may be in further waiting or pursuing costly upgrades or studies. Actively addressing the queue of projects also ensures the most viable projects remain to be considered for interconnection.

#### **4.0 RESULTS – DYNAMIC ANALYSIS OF GENERATOR TRIP EVENT**

To assess the impact of distributed PV on system and on time variant conditions, dynamic analysis must be performed using an appropriate model. This portion of the Proactive Approach uses the PSS/E model to conduct dynamic analysis. The model is built in the licensed PSS/E software

developed by Siemens. The proprietary transmission system data set for Oahu originates from Hawaiian Electric's Transmission Planning group, and forms the basis of the analysis.

The dynamic portion of the Electric Cluster study is aimed at identifying any technical violations due to transient events at sub-transmission and transmission circuit levels – in this case the transient event is the scenario where the largest generator on the transmission system trips offline. The dynamic studies criteria for PV penetration limits are:

- Extra load shedding (compared to case with no PV) due to under-frequency inverter trips; and,
- Extra load shedding (compared to case with no PV) due to over-voltage inverter trips.

Similar to the steady-state analysis, the dynamic analysis follows a data review and model validation process. Once validated, the simulation is conducted based on a prescribed scenario which in this case is a N-1 or contingency event due to the loss of a large generator on the transmission system. Other contingencies will need to be assessed but to show the connection of the steady state and dynamic models for the Proactive Approach, this scenario example is described for the circuits evaluated.

#### 4.1 Analysis Process

To capture the distributed PV impacts, the existing Oahu transmission model had to be extended with distribution infrastructure information based on the Electric Cluster models in SynerGEE. Figure 4.1 illustrates the additional modeling architecture that was added for the purposes of this. It should be noted that the existing transmission model includes further systems above the 138kV branch shown in blue in Figure 4.1 (such as other 138kV sub-stations and generation connected to the transmission system), and the section shown in green was added as part of the model enhancements to incorporate the impact of the distribution system and distributed DG, as part of the distribution network and to capture the PV as distributed generators.



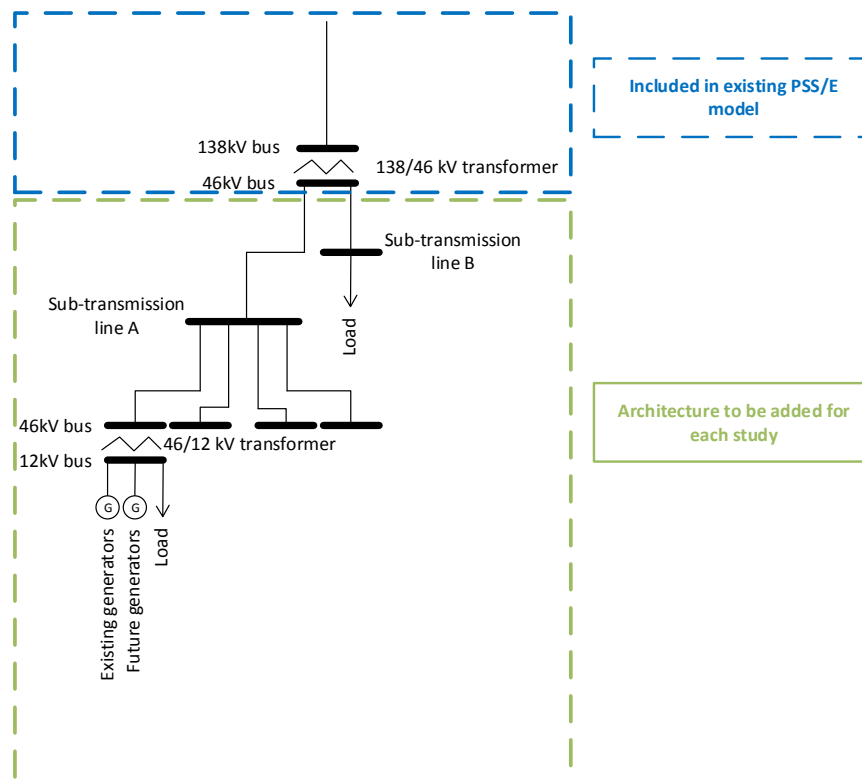

Figure 4.1. Dynamic Model Architecture includes Distribution Level representation in the Transmission Model.

The transmission data set originally provided runs from the 138kV level down to the 46kV side of the 138/46kV transformers in the system, but does not include anything beyond this level (i.e. it does not include the actual 46kV sub-transmission lines or the 12kV distribution circuits). Therefore, for each Electrical Cluster study performed, the 46kV sub-transmission line is added to the relevant transformer, along with a 46/12kV transformer to represent each sub-station on the 46kV feeder. On the 12kV side of each of the 46/12kV transformers the existing generators are aggregated to a single generator, the future generators (used for the increased PV penetrations) are aggregated to a separate single generator, and the load is aggregated to a single load. This is illustrated in Figure 2.2.

The rationale for aggregating the generators in this way is that

- 1) it is understood that the existing PV generator inverters will disconnect at a different frequency level to the future PV generator inverters, and that all inverters with the same settings will behave the same way; and
- 2) it reduces the complexity and processing time, but it should be noted that the voltage drop (or rise at higher PV penetrations) along the 12kV feeder is not considered in this analysis. As discussed in Section 2.4.3, voltage drops along a circuit in the direction of current flow due to the resistance of the conductors. In the worst cases, the maximum voltage drop from the 12kV feeder head in the steady-state analyses is 1.1%, while the maximum voltage rise from the 12kV feeder head is 0.475%. The voltage rise value is considered more significant in this analysis as over-voltage tripping is more likely than under-voltage.

If the dynamic analysis produces a result where the voltage is very close to the disconnect setting of the inverters, it should be checked whether it is within these ranges of the disconnect setting. The settings assumed for the inverters are given in Table 4.1. Clearing times represent the time for which the disconnect criterion must be maintained in order for the inverter to disconnect from the circuit.

Table 4.1. Inverter Trip Settings.

Setting	Disconnect Criterion	Generators Clearing Time
<b>Under voltage</b>	$V < 50\%$ of base voltage	10 cycles (0.16 seconds)
<b>Under voltage</b>	$50\% < V < 88\%$ of base voltage	120 cycles (2 seconds)
<b>Over voltage</b>	$110\% < V < 120\%$ of base voltage	60 cycles (1 second)
<b>Over voltage</b>	$V > 120\%$ of base voltage	10 cycles (0.16 seconds)
<b>Under frequency – Future Generators</b>	Frequency $< 57$ Hz	10 cycles (0.16 seconds)
<b>Under frequency – Existing Generators</b>	Frequency $< 59.3$ Hz	10 cycles (0.16 seconds)
<b>Over frequency</b>	Frequency $> 60.5$ Hz	10 cycles (0.16 seconds)

## 4.2 Input Data

The transmission model in PSS/E includes a data warehouse of information on equipment to include in that model. However, as PSS/E is typically a transmission model, the 12 kV distribution equipment data does not exist. For distributed generation and distribution architecture representation, the equipment data is imported into PSS/E from the SynerGEE model so that the model parameters remain consistent between the steady-state studies and dynamic analysis.

The dynamic model also includes load data at the 46kV level of the 138/46kV transformer (see Figure 2.5), while for the study this must be broken down by each 12kV distribution circuit. Each of the 138/46kV transformers feeds either one or two 46kV sub-transmission lines. The load given in the model is therefore split between the two sub-transmission lines for the purposes of the study, and the split is calculated in proportion to the peak load value of the connected feeders. As the cluster study generally concerns only one 46kV line, the load on the other line connected to the 138/46kV transformer can be aggregated at a separate 46kV bus. The load on the sub-transmission line under study is further broken down by the 46/12kV transformers, again in proportion to their peak load.

A snapshot of the system or point of reference was desired at the onset of this study. To meet the timeframe of the project, the existing distributed generation (DG) capacities used for this analysis are thus from a June 2013 level provided by the utility planning coinciding with the latest version of Hawaiian Electric Company

the model for the distribution infrastructure at the time of project initiation. DG resources included planned power purchase and distributed generation comprised of Net Energy Metering (NEM), Feed in Tariff (FIT) and Standard Interconnect Agreements (SIA). As the cluster evaluations are completed, the desire is to conduct the evaluation to a common reference data to provide a baseline reference for the system. Future changes and upgrades that are required can thus be determined based a point of reference.

The capacity of future generators required to scale-up the total distributed generation to 135% of peak load is calculated and represented as distributed generators at the 12kV side of the 46/12kV transformers, along with the existing aggregated PV generators. The relative capacities and loads are given in Table 4.2. Note that the Peak and Minimum Loads specified in this table refer to the Cluster’s portion of the peak and minimum load across the whole HECO transmission system, while the generator capacities are calculated based on the Cluster’s specific peak load. This is the reason why the existing plus future generator capacity does not equal 135% of the peak load specified in this table.

Table 4.2. Cluster Load and PV Generation Scenarios.

Cluster	Peak Load (MW)	Minimum Load (MW)	Existing PV Generators Capacity (MW)	Future PV Generators Capacity (MW)
<b>Electrical Cluster A</b>	25.62	21.61	2.63	26.17
<b>Electrical Cluster B</b>	29.00	20.1	3.67	50.44
<b>Electrical Cluster C</b>	31.18	20.29	3.02	29.05

### 4.3 Analysis Process

Four analyses are performed, with the intention of capturing the extreme cases. These analyses are defined as follows:

1. Minimum load with no PV installed to establish a baseline reference.
2. Peak load with no PV installed also to establish a baseline.
3. Minimum load with PV equivalent to 135% of peak load.
4. Peak load with PV equivalent to 135% of peak load.

For analyses 3 and 4 above, the PV is separated into two categories – existing PV and future PV, as discussed above. For modeling purposes, there was a desire to investigate how different inverter settings impacted under-frequency trip response on the system. For this analysis, an assumption was made to leave all existing PV at 59.3 Hz trip setting and the future PV at the 57 Hz trip setting, as specified in Table 2.6. Since September 2013, new policy for inverter trip settings to conform to a 57 Hz trip requirement was adopted by the Hawaiian Electric Companies so this assumption may result in more aggressive PV system trips than what currently may occur now during an under-frequency event. However, as PV inverter systems are not monitored by the utility nor maintained similarly by residential customers in the same fashion, having an understanding of what the more aggressive response levels are helps gauge proper response and action for system reliability.

In each analysis the following process is performed:

- System is run in existing state up to 10 seconds with no disturbances imposed to check model stability;
- Largest generator (in this case the AES generator at 201 MW) is tripped offline; and,
- Simulation continues for 60 seconds and inverter trip and load-shed events are identified and quantified.

Within the timeframe of this effort, dynamic analysis will not include inverter re-closing (re-connecting after they have been tripped) operations up to 300 seconds of analysis. While this scenario is very important for understanding of system restoration after a generator trip event, it requires additional analysis that is beyond the timeframe of this study effort. This scenario is a critical dynamic study as part of high penetration PV impact analysis and will be conducted as part of the Proactive Analysis under continuing utility investigation efforts.

Other assumptions for modeling include:

- Instructions for load shedding (disconnection of customers to restore system frequency). Load shedding occurs when the frequency or voltage are outside the specified ranges for a specified period of time. The load shedding settings are as given in the transmission model prescribed by the utility based on critical loads and circuit loadings.
- The spinning reserve is specific to the fault event. In this case, the spinning reserve is the amount to cover the AES generator. The simulation covers the case where the utility would be able to source power from a back-up generator to cover for the loss of one of the generators on their transmission system. No spinning reserve is added to this to cover the PV which may be disconnected and no other generation is turned on after the simulated fault. This is based on the current assumption that the utility does not supply back-up generation for the distributed generation over which it has less control.

As the analysis proceeds, these assumptions may need to be further refined or changed and analysis can be rerun to compare results. Results obtained within the timeframe of this effort are based on the scenario described above and assumptions are presented.

#### 4.4 Results and Analysis

Results based on an initial run are presented in Table 4.3. In the Minimum Load case the installation of the PV generators showed no significant impact on changing the amount of load shed in response to a generator outage. Note that the PV generation tripped is equivalent to the existing PV generator capacity, and these are the only generators that were tripped.

Using the Peak Load condition, initial results showed that installation of PV generators caused less load to be shed than in the case with no PV generators, which is counter-intuitive as this would lead one to presume that installing more PV may have positive impacts on load shed. However upon further analysis, the modeling assumptions were unrealistic in terms of the actual operations including dispatch of the generators.

Table 4.3. Cluster Load and PV Generation Scenarios.

Load Case	Load Shed – No PV (MW)	Load Shed – With PV (MW)	PV Generation Tripped (MW)
<b>Minimum Load</b>	71.87	71.87	9.32

<b>Peak Load</b>	173.8	84.68	9.32
------------------	-------	-------	------

Further investigation of the initial scenario set-up and the frequency profiles shows that the result of less load shed at peak load condition is due to a modeling assumption that kept conventional generators running at reduced capacities and operating at un-realistically low levels where they were technically inefficient. In the simulation, when the N-1 contingency event occurs with the trip of a generator, these other generators are all running and have the response capability to increase their output, which prevented the system frequency from showing the necessary load shed response. This condition was further investigated by re-dispatching and de-committing 2 generators to compare this condition with the prior assumption.

An example analysis has been performed in which two conventional generators are selected to be turned off in order to accommodate the addition of the PV generators. The results – shown in Figure 4.2 - show that in this new case the frequency drops below the lowest frequency found in the other two cases, which suggests that load shedding would be equal to and likely higher than the load shed in the case with no PV. This is only an example of how the assumptions affect the results of this analysis, and should not be used to determine what dispatch should actually occur.

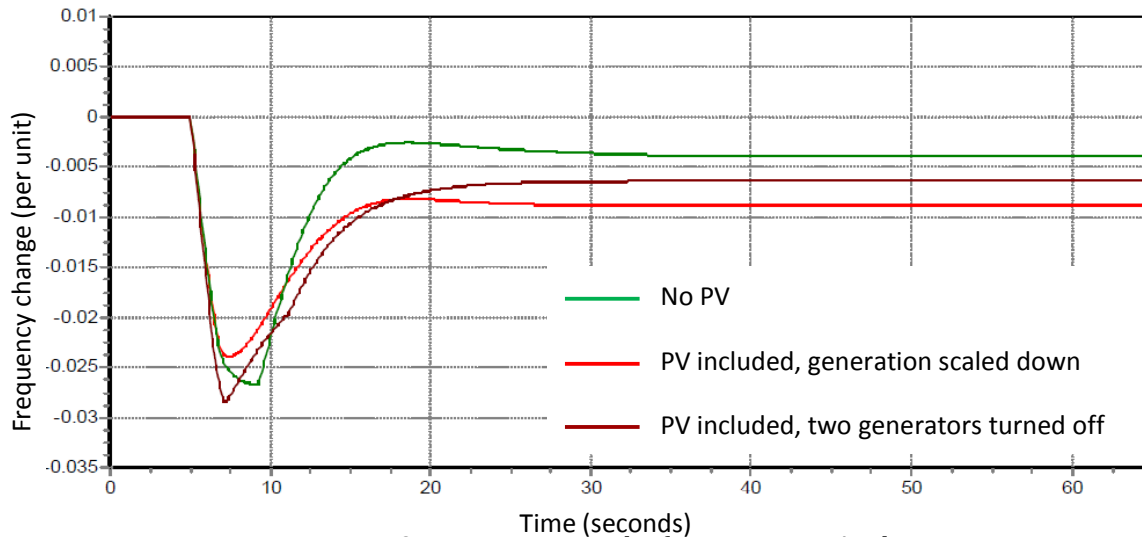

Figure 4.2. Frequency Results from Dynamic Analyses.

Based on this dynamic analysis, distributed generation does have an impact on system performance especially during contingencies such as the N-1 condition evaluated. Additional evaluation and careful consideration of the generator dispatch and contingency response of the system needs to be re-evaluated given high penetration PV impacts.

In this case (Figure 4.2), the results show that in the case with ‘PV with two generators turned off’, the rate of system frequency change shows the steepest slope compared to the other cases with ‘no PV’ on the system and ‘PV with generation scaled-down’. The ‘PV with two generators turned off’ also dips to the lowest point of the three analyses, which indicates that addition of PV in this case causes the same or more load to be shed compared to the case with ‘no PV’. Further investigation and evaluation by the utility’s planning department will be needed to ascertain appropriate levels of dispatch that also consider other contingencies not included in this analysis. These results highlight the importance of integrating distribution impact analysis on system performance as

penetration levels increase. Impacts may be as far reaching as considering PV impacts on long range generation planning, on combination of units dispatched and on scheduling of utility generators for maintenance. Units available must also account for a new condition of variable PV output and aggregated performance as distributed generators, in addition to the traditional consideration for ensuring adequate coverage of reserves and system inertia to preserve grid frequency during contingencies.

#### 4.5 Summary of Dynamic Case

The dynamic study presented here is performed to identify any impacts on load shedding due to increased installation of PV systems on the three clusters analyzed. The analysis is performed in peak load conditions, with and without PV in order to capture the extreme cases. In the cases where PV generators are included, they are modeled in two separate forms – existing and future generators – in order to capture the effect of differences in their under-frequency trip settings. In the main analysis, the PV generators are accommodated in the dynamic model by reducing the output of the conventional generators proportionally in order to maintain the balance between overall generation and load.

The results of the main study show that in this case – with the conventional generator output reduced across the system – adding PV generators has a positive effect in that less load was required to be shed. Further investigation shows that this result may be unrealistic and is dependent on how the conventional generation is modified to accommodate the PV generators. An example analysis is performed to assess the effect of changing this assumption. In this example analysis, instead of reducing the output from all conventional generators, two of the generators are switched off completely while the others remain at their original output.

Based on this dynamic analysis, distributed generation does have an impact on system performance especially during contingencies such as the N-1 condition evaluated. Additional evaluation and careful consideration of the generator dispatch and contingency response of the system needs to be re-evaluated given high penetration PV impacts. System events and DG monitoring is recommended to investigate if reliability issues are being encountered but masked due to limited monitoring of distribution level impacts and traditional modeling assumptions which may not adequately account for the impact of distributed generation in current planning practices. Re-evaluation of the system dispatch may be needed along with an update performance and response from conventional generators to accommodate variability impacts of distributed PV.

#### 5.0 Mitigation Measures

The studies on the impacts of high distributed PV penetrations on the distribution feeders, substations and transmission lines have concentrated on

1. Determining PV penetration thresholds and likely exceedance limits based on technical criteria that can help mitigate adverse impacts on the security, reliability and stability of the grid.
2. Once the thresholds and limits to PV penetration are reached, the question is how much can be afforded and should be done to upgrade and mitigate impacts to further accommodate PV.
3. Based on mitigation studies determine practical solutions based on cost and benefit.

If cost effective mitigation measures can be determined that also improve reliability and stability and facilitate increased PV penetrations, they should be prioritized and pursued.

As solar generation mostly impacts the midday time period between 10am and 4pm, atmospheric conditions, such as cloud formations, that generate variability in solar generation need to be accounted for. Effective mitigation measures using advance solar and wind forecasting by Hawaiian Electric Companies are currently being pursued [5, 6, 7] and are being piloted with federal support to reduce system impacts and facilitate increasing renewables on the system [8].

Some of these measures may require additional controls to be installed at the customer side to better manage solar systems while others require increased capital investment in infrastructure to upgrade monitoring, protection and telecommunications for transferring data in real-time. To make these measures acceptable to utilities and ratepayers requires universal support, despite monetary impacts.

The types and magnitude of mitigation measures are dependent on the circuit configuration, customer mix and PV penetration as the studies have shown. As proposed to be investigated using the Proactive Analysis, simulation based studies can be used to evaluate the most cost-effective measures, determine strategically which feeders to deploy and determine under what conditions (steady-state and transient) responses need to be. The feeder analysis work being conducted currently lays the framework for studying mitigation measures. Once the maximum thresholds for PV penetrations have been reached, these studies can also be used to assess expansion needs and evaluate broader mitigation measures as the grid modernizes and changes. New technologies that are appropriately modeled can then be simulated for their effectiveness without sacrificing the reliability and performance of the existing system.

Table 5.1 shows a partial list of potential mitigation measures that could be implemented under steady-state and first contingency conditions. The list may likely expand to capture other mitigation measures considered as similar transient and dynamic studies are performed.

Table 5.1. Listing of potential mitigation measures.

Mitigation Measure:	Applicable Adverse Condition:						
	Voltage High	Voltage Low	Backfeed	LTC Cycling	High Fault Current	Feeder Over Loads	
<b>Level voltage and lower LTC settings</b>	X	X					
<b>Capacitor relocations</b>	X	X					
<b>Energy Storage</b>							
	Located on Feeder	X	X	X			
	Located on Residential or Commercial Site	X	X	X		X	
<b>Inverter curtailments</b>	Clipping voltage	X					
	Turning off inverters	X		X			
<b>Regulating Transformers</b>	Voltage	X	X				
	Reactive power	X	X				

<b>Inverter functionalities</b>	Voltage	X	X				
	Frequency						
	Reconnect times	X	X				
	Reactive power	X	X				
	Solar power ramping	X					
<b>Upsizing distribution transformer</b>							X
<b>Increase secondary cable sizing</b>							X
<b>Adding distribution transformer &amp; splitting load</b>							X
<b>Protection upgrades</b>					X	X	X
<b>Demand response-turning on equipment</b>	AC		X	X			
	Water heaters		X	X			
	EV		X	X			
<b>Demand response-turning off equipment</b>	AC	X					X
	Water heaters	X					X
	EV	X					X

As discussed in the previous sections, PV penetrations impact system conditions at different percentage levels. For example, the PV penetration level required to impact fault current is different than the PV penetration to cause backfeed. As each of these penetrations is reached, there are certain mitigation measures that could reduce or eliminate the problem. Not all of these mitigation issues solve the same problems. For each cluster analyzed above, the mitigation measures are studied one at a time to determine which measure solves the feeder problem, and at what cost. Then the PV can be increased until the next problem is found. This iterative process continues until all of the problems are solved and a new maximum PV is determined. It is probable that the mitigation costs will be prohibitive before all of the reliability issues are solved.

Hawaiian Electric has begun studying and evaluating each of these mitigation measures [9, 10]. As the studies are completed, the reports will be expand the current knowledge base on addressing high penetration needs and also help to explain the costs and economic benefits of various mitigation strategies. As cost values become available, they should be added to each mitigation measure consideration as noted in Table 5.1.

Each of these mitigation measures provides different values to both the utility and the distributed PV owner. A brief description of each is listed below.

**Level voltage and lower LTC setting** – The utility conducts power flow simulations to determine the optimal place to install line capacitors or line regulators to levelize the distribution voltage across the distribution feeder and the secondary service drops. This allows the utility to lower the voltage at the substation bus so that the LTC operates to a lower bus voltage.



The utility would need to check the required voltage regulation under different customer loads and PV penetrations to determine when the capacitors would need to operate. The utility would also need to verify that this LTC setting does not impact the other distribution feeders on the same bus.

Pros:

- Reduces voltage overloads created from high PV penetrations
- Reduces LTC operation by maintaining a uniform voltage across the feeder by reducing variability of voltage
- Could be an economical solution given the lower cost of capacitor banks compared to other alternatives

Cons:

- Increases current flow on distribution feeder and increases line losses
- Can cause low voltage on other distribution feeders connected to the same bus
- Setting of capacitor operation for varying seasonal load could be complicated due to the large number of capacitor banks installed. This requires maintaining a record of every capacitor and developing a comprehensive maintenance schedule. The periodic switching of feeder segments for maintenance or outage conditions could result in the capacitor banks operating incorrectly. May need to have periodic checking of capacitor size and location as PV increases

Capacitor re-locations – This is a function that is periodically conducted by the planning departments. The distribution feeders are simulated to determine if the current capacitor and regulator settings are still appropriate. These periodic studies would be expanded to study various distributed PV penetrations to determine how the capacitor locations could change with load growth and increasing PV penetrations. This analysis would also require conducting protection studies to determine if the coordination between capacitors, substation equipment, and line fuses are still correct. This study will investigate the current locations of capacitor banks and where to locate the capacitors if existing locations are creating problem issues. The study results could then be used to describe the before and after results of locating the capacitors.

Pros:

- Can be a quick and easy fix to voltage issues
- Development of written protocols and seasonal settings could enable the maintenance staff to easily track the location and settings to schedule required maintenance and capacitor operational changes.
- Would not impact other distribution feeders on same substation bus

Cons:

- Control logic may need to be more sophisticated compared to current logic, hence, requiring more data. For example, the simple setting of fixed and time based may not be accurate enough. The settings may need to be upgraded to provide for more flexibility to operate as the PV output varies by season and load.
- Requires yearly assessment on the capacitor locations and control logic
- Requires seasonal inspection and re-setting of controls

Energy storage – Types of energy storage installations can include those located on the distribution and/or subtransmission feeder and those located at the residential or commercial site

Energy storage devices allow for the storage of excess energy to be used to regulate solar variability and reduce backfeed onto the distribution feeder and substation bus. These devices

provide local control to regulate a limited service area. Solar developers are offering storage/solar installations currently. Battery standards and impact on system will also need to be considered. Long term viability of chemistry based batteries also needs to be resolved.

Pros:

- Reduces backfeed onto distribution feeder and substation bus
- Reduces fluctuations in generation from solar variability
- Provides additional generation when needed
- Can be used to control a wider range of voltage issues when installed on distribution feeder

Cons:

- Controlling residential and commercial storage is an issue since the storage devices are located behind the customer meter. Storage controls could be unavailable.
- Cost of storage is very high. A 1 MW device could cost over \$1.5million.
- Lack of track record of diverse commercially available storage options. The types of commercially available battery types with long track records are currently limited. There are many being tested in laboratories and at beta test sites but not very many commercial.
- Safety and security is an issue. The failure of lead acid batteries can cause fires, emit toxic fumes and other harmful elements.
- Waste and disposal of chemistry based batteries need to be considered.

Inverter curtailments – Since there are limited times during the year when PV inverters can create high voltage on the distribution feeder, the utility could add operational logic to the inverter controls to regulate the operation of distributed PV installations. Considerable efforts are being discussed by IEEE and industry on standardizing inverter settings to limit power output so as not to create high voltage. When the voltage at the customer meter reaches 125 voltages, the inverter will limit solar generation to the value until the voltage reduces. The utility could also setup controls using the smart meters to control the operation of the inverter, even shutting the inverter off.

- Option 1: set an upper voltage limit (clipping voltage) on the inverter to maintain a pre-determined voltage level by limiting or reducing PV generation. The control limits PV generation through voltage settings.
- Option 2: Install remote controls on every distributed PV installation to allow the utility to turn the PV inverters on and off to control voltage.

Pros:

- Uses internal inverter logic to control voltage (Option 1), if available
- Could be a quick fix to high voltage conditions on the distribution circuits (Option 1)
- Enables utility operators additional generation controls for incident occurrences (Option 2)
- Curtailing PV generation could be a short term option but longer term strategies need to be considered from customer perspective including duration of curtailment and repayment.

Cons:

- Reduced energy output for PV owner (Option 1, Option 2)
- High cost for controls (Option 2)
- Lack of permission for utility to control customer-owned PV systems (Option 1, Option 2)
- Requires annual updates of PV installations, voltage set points and cost impacts

Regulating transformers – Regulating transformers can be installed either on the secondary service drops or the distribution feeder at strategic points to regulate voltages and reactive power. Demonstration projects are being conducted on utility systems to test for operation and functionality. A regulating transformer is a standard utility transformer with regulator solid state

controls. If there is an existing transformer in the field, the solid state regulator could be interconnected with the transformer to make a regulating transformer.

Pros:

- Commercially available regulating transformers are now emerging on the market and being tested by utilities in the near term as compared to other options such as batteries, fuel cells, utility controlling customer equipment.
- Controls can be attached to existing pad mount or pole mounted distribution line transformers
- Equipment costs could be very economical since the regulating equipment can be installed on existing transformers
- Time to install and maintain could be low compared to other options. For example, the utility would not be required to be field checked every season or every year as the case for capacitors.

Cons:

- Full life-cycle and maintenance costs are unknown
- Could require high utility maintenance to check a high volume of secondary service installations
- Data delivery to control center could result in high cost upgrades to monitor efficiency. If every transformer requires separate communication equipment to send information back to the control room and then every data sent (1 second, 1 minute, 5 minutes and so on) requires larger storage capability

Inverter functionalities – There are at least five new functions to improve the inverters participation in maintaining reliability and security. These include controlling voltage, controlling frequency, providing reactive power, limit solar power ramping, and staggering reconnect times after incident events. The current inverter logic may not currently have these functions available and a future inverter upgrade would be required. These are not commercially available yet and are only being studied to determine their capability and benefits.

Pros:

- Provides each inverter with its own internal control mechanism
- Reduces utility intervention to control
- Provides utility with increased reliability, security controls and options

Cons:

- May require inclusion in the next inverter logic upgrade
- Could violate current rules and regulations
- May require additional data to automate controls or new inverter logic and a determination of who is paying for these functions.
- Equipment costs may increase if there are new control functions
- Adverse impact to existing circuit protection schemes. Having a large number of inverters changing feeder values while other equipment is also changing values could result in unnecessary equipment trips and unit failures. Even if a system could be designed for one feeder, if feeder segments are switched to other feeders for maintenance or outages, there is no guarantee that the systems would continue to operate properly.

Increasing distribution transformer size, increasing cable sizes, adding distribution transformers and splitting load, protection upgrades – These options are utility modifications to the feeder and the secondary service drops and need to be considered as part of larger grid modernization needs.

Hawaiian Electric Company

Task 3 Deliverable – Draft Cluster/Circuit Analysis Results

The utility can implement these without PV owner participation or changes in the inverter logic or operation. The upgrade costs will increase with current and future levels of PV, and determination of a ratepayer structure to cover these costs will need to be addressed. These potential solutions will not work for every feeder and penetration scenario, and will require a detailed study for each feeder with distributed PV.

Pros:

- Does not require PV owner participation
- Utility can study and plan for future upgrades based on projected penetration levels
- Does not require changes in inverter logic

Cons:

- Increases capital investment by utility
- Requires shared payments from PV owners to cover the increased investment
- Is a short term fix with high cost

Demand response options – The utility could implement various demand response options that turns on or off certain residential or commercial equipment during critical periods. Depending on the load versus solar capacity, the demand response may need to turn on equipment or turn off equipment.

Pros:

- Does not require major equipment upgrades from the utility
- Increases control of load instead of solar variability which is easier to implement

Cons:

- Ratepayer must agree to having behind the meter load controlled by the utility
- Could impact utility revenue
- May create a diminishing return or value as options are implemented. A perfect example is the controlling of air conditioners. Customers could be open to having their AC controlled during high ambient temperatures for a while. However, customers could lose interest due to the small amount of funds that they would receive during high temperatures. Hence, they would soon realize that the payments are not high enough for them to sit in their homes being hot.
- Lack of visibility to available demand response loads
- Lack of communication infrastructure
- Lack of backhaul and analysis infrastructure with appropriate controls by utilities

## 6.0 SUMMARY & RECOMMENDATIONS

The Proactive Modeling methodology was initially developed to study high penetrations of PV on Oahu distribution circuits already experiencing high PV growth. The objectives of this effort were to apply the Proactive Modeling methodology and demonstrate how the approach can be used to consistently and transparently be used to determine high penetration PV impacts on the feeder and the system. The effort defines a new process for proactively monitoring, modeling and tracking the changes on the distribution infrastructure. Given the information, interconnection of PV systems can potentially be streamlined using an cluster analysis approach. Results identify system constraints, help quantify impacts and provide infrastructure upgrade options to accommodate current and future growth of distributed PV.

## 6.1 FEEDER RESULTS AND STREAMLINING BENEFITS

From the initial study, the methodology was developed and improved upon through lessons learned. With the successes and shortfalls of past analyses, the methodology was updated as needed and has developed into its current state, providing a well-defined process and guidelines to conduct high penetration PV studies and report results in a consistent and efficient manner.

In this way, the three Electrical Clusters of this study were analyzed using the Proactive Modeling methodology and have realized the benefits of a standardized routine for analysis and reporting. Study phases for each of the three Electrical Clusters were completed within 2 weeks given the “plug-and-play” nature of the data validation, prioritization and reporting process. Expanded analysis results and mitigation solutions can also be implemented for a variety of conditions.

In summary, electrical clusters on the island of Oahu were assessed using the Proactive Methodology with the aim to find limitations on the distribution circuits, validation processes were performed for the transformers, and finally the effects on the system were identified at existing PV penetration levels and future scenario levels.

### Cluster A

- At the time of the analysis, the simulation results show that one out of nine circuits in Cluster A has existing PV penetration levels already in excess of the backfeed limit, which suggests that it may already be experiencing reverse power flow or backfeeding. Distribution feeders, transmission lines carrying electricity to a distribution point, are traditionally not designed to carry bidirectional power flow; therefore a number of issues can be occurring when distributed generation causes reverse power flow as this condition occurs when PV generation exceeds the demand (including losses) on the feeder. Additional protective monitoring devices may be recommended for this area.

### Cluster B

- Simulation results show that two out of nine circuits in Cluster B have existing PV penetration levels in excess of the 5% fault current rise limit. Fault current occurs when too much current flows through the electrical power grid in an uncontrolled manner. This event causes short-circuits, which result in a rapid increase in the electricity drawn from power sources within the grid. This condition if unchecked can lead to cascading or rolling blackouts. If the fault current is higher than the capacity of the protective devices on the system, this can lead to these devices not performing properly and not protecting the distribution circuit which can impact everyone on the circuit. Another identified issue on this particular cluster is the condition of excessive backfeed. Additional monitoring is recommended along with more frequent assessments. Mitigation strategies will need to consider system impacts which require more than standard interconnection models as described in this analysis.

### Cluster C

- At the time of the analysis and with existing levels of distributed PV, the simulation results show that these circuits are within the backfeed limit, which suggests that they are unlikely to experience reverse power flow. However, with the queued PV penetrations on the system accounted for in the simulations, and if all of this queued PV on the distribution circuits is implemented, backfeed limits will be exceeded. Given this understanding,

additional upgrades including protective devices can already be considered to look at resolving or limiting the PV on certain feeders, installing bi-directional monitoring on protective devices and also requiring additional controls at the distributed PV level depending on the type of projects (e.g. NEM, FIT, SIA)

Based on this set of steady-state results and preliminary dynamic analysis, the Proactive Modeling methodology has demonstrated capability to provide valuable insight to distribution level and system constraints given different scenarios of PV penetration (existing and future potential). Results demonstrate the importance of integrating distribution impact analysis on system performance, especially at high penetration levels. Aggregated PV response and output levels at high penetration may have far reaching impacts on traditional system planning considerations, such as on long range generation planning, on combination of units dispatched and on scheduling of utility generators for maintenance. These traditional system planning considerations will also need to account for a new type of distributed generator on the system. New parameters governing variable PV output and aggregated performance need be captured through new industry policy and requirements and factored in to realistically plan grid reliability and contingencies for the future. Using a more proactive, simulation-based modeling process connecting impacts of DG with system models provides the utility valuable information and capability to look-ahead on critical conditions that may impact reliability and safety and thus inform follow-on decisions or action. Proactive assessments provide continuous tracking and monitoring of critical feeders in a systematic and transparent fashion. The methodology also links distribution and transmission level impacts to inform more robust and cost-effective mitigation measures, even ahead of concerns. The ability to proactively plan ahead enables integration of more viable and appropriate renewable technologies and grid modernization needs.

## 6.2 NEXT STEPS

This report captures the Proactive Process and results from 3 diverse electrical clusters on the island of Oahu covering over 20 distribution feeders. Each feeder now has a percentage level where a condition or threshold of exceedance has been determined using a Grid Impact Factor (GIF) for the interconnected transformers. Positive GIF values show the Cluster has low impact on the grid and negative GIF values indicate mitigations are needed. Efforts in this analysis demonstrate the applicability of the Proactive process to prioritize, validate and consistently conduct model evaluations and assess mitigation strategies. As such what use to take 6-9 months of building models and validating data can be completed in a 2-3wk cycle. This enables more frequent and routing monitoring of the impacts. The goal is to complete assessment on the island of Oahu following the same methodology.

The approach also enables utilities to conduct scenario-based analysis to proactively assess demand for PV on the feeder as part of routine planning. Maui and Hawaii islands are moving ahead on scenario-based analysis based on DG impacts at the system level. By modeling and identifying feeder thresholds using a range of increasing penetration levels of DG on a feeder coupled with the ability to aggregate impacts up to system levels via cluster models, existing utility modeling tools can be proactively used to study, identify and capture impacts of distributed PV. This has significant benefits in helping to inform mitigation strategies and interconnection studies, a priori. These simulation-based analysis results can also be used to identify potential issues across the system versus just one location and support investigations to formulate mitigations and costs factors that have application across multiple projects.

Remaining Task 4 analysis focuses on

- Continuing with dynamic modeling analysis using PSS/E to evaluate contingency conditions and assess mitigation technologies based on the results from clusters analyzed. Issues identified and “hotspots” will be visually rendered and communicated through outreach and presentation materials; and
- Using models to evaluate a mitigating technology for a high voltage or backfeed condition on the feeder for effectiveness and applicability.

Final task will begin to compile results and mitigations applicable to similar types of clusters and feeders on Oahu, as well as on other islands. Upon completion, this 5 month effort will have documented and demonstrated a consistent methodology for conducting proactive studies on high penetration PV feeders, developed a robust mitigation options list and provided recommendations on strategies to use simulation based analysis to proactively plan and monitor interaction between system and distribution system and impacts due to distributed generation.

In terms of next steps, recommended utility actions include:

- Continue and complete additional clusters studies using the Proactive Modeling process for the island of Oahu;
- Integrate results and lessons learned from the Proactive Process into transmission and distribution planning’s model maintenance practices;
- Develop a list of mitigation criteria based on issues observed and modeled;
- Use integrated models to assess the effectiveness and reliability of mitigation options as part of a cost benefit analysis;
- Link timing of evaluations and re-evaluations of feeders to current resource procurement tariffs and interconnections on the feeders to reflect current conditions and levels of penetration;
- Apply, assess and recommend implementation of mitigation measures per analysis, as appropriate.

## 7.0 REFERENCES

- [1] Hawaiian Electric Company, "Cluster Evaluation Methodology", Hawaii Grid Cluster Evaluation Project Task 2.1 Report, DBEDT, Jan 2014.
- [2] Hawaiian Electric Company, "Circuit Evaluation and Selection", Hawaii Grid Cluster Evaluation Project Task 2.2 Report, DBEDT, July 2014.
- [3] DNV GL SynerGEE Model Website:  
[http://www.gl-group.com/en/powergeneration/SynerGEE\\_Electric.php](http://www.gl-group.com/en/powergeneration/SynerGEE_Electric.php)
- [4] Siemens PSS/E Model Website: <http://w3.siemens.com/smartgrid/global/en/products-systems-solutions/software-solutions/planning-data-management-software/planning-simulation/pages/pss-e.aspx>
- [5] Zack, J. "Renewable Energy Forecast at Hawaiian Electric Company," Asia Pacific Clean Energy Conference, September 2013,  
<http://www.ctsi.org/events/APCE2013/program/pdf/John%20Zack.pdf>
- [6] Nakafuji, D., Dangelmaier, L., and Reynolds, C., Hawaii Utility Initiatives to Enable Wind (WindHUI)", Final Technical Report, DOE/EE0001379,  
<http://www.osti.gov/scitech/servlets/purl/1049311>
- [7] Orwig, K. et al, "Recent Trends in Variable Generation Forecasting and Its Value to the Power System," IEEE Journal Paper, 2013 (submitted).
- [8] Greentechmedia, "Sunshot Launches \$60 Million in DOE Money to Improve Solar," October 2013, <http://www.greentechmedia.com/articles/read/SunShot-Launches-60-Million-in-DOE-Money-To-Improve-Solar>
- [9] High Penetration PV Initiative (HiP-PV), California Public Utility Commission California Solar Initiative website: <http://calsolarresearch.ca.gov/funded-projects/66-high-penetration-pv-initiative>
- [10] Nakafuji, D. et al, "Visualization of High Penetration PV," HiP-PV Project Report, CPUC CSI Consultant Report, July 2013,  
[http://calsolarresearch.ca.gov/images/stories/documents/Sol1\\_funded\\_proj\\_docs/SMUD/SMUD-HECO\\_Task-4\\_PilotVisual\\_FinalRpt\\_2013.pdf](http://calsolarresearch.ca.gov/images/stories/documents/Sol1_funded_proj_docs/SMUD/SMUD-HECO_Task-4_PilotVisual_FinalRpt_2013.pdf)



# Hawaii Grid Cluster Evaluation Project

Proactive Approach for High Penetration PV  
Cluster/Circuit Analysis & Mitigation Assessment  
Project Report

**HAWAIIAN ELECTRIC COMPANY**

June 2014



Hawaiian Electric  
Maui Electric  
Hawai'i Electric Light

## **Proactive Analysis Results**

### **Task 4: Proactive Approach for High Penetration PV Cluster/Circuit Analysis & Mitigation Assessment**

**Submitted to the**

**Hawaii State Energy Office**

**Hawaii Department of Business, Economic Development, and Tourism**

**by**

*Contributing Authors*

Hawaiian Electric Company:

Dora Nakafuji  
Amra Brightbill

DNV:

Jonathan Flinn,  
Ronald Davis

**June 2014**

### **Disclaimer**

This report was prepared as an account of work sponsored by an agency of the United States Government. Neither the United States nor any agency thereof, nor any of their employees, makes any warranty, express or implied, or assumes any legal liability or responsibility for the accuracy, completeness, or usefulness of any information, apparatus, product, or process disclosed, or represents that its use would not infringe privately owned rights. Reference herein to any specific commercial product, process, or service by trade name, trademark, manufacturer, or otherwise does not necessarily constitute or imply its endorsement, recommendation, or favoring by the United States Government or any agency thereof. The views and opinions of authors expressed herein do not necessarily state or reflect those of the United States Government or any agency thereof.

### **Acknowledgements**

This material is based upon work supported by the Department of Energy and the State of Hawaii Department of Business, Economic Development, and Tourism under award number DE-EE0005354/0005. Efforts build on methodology utility proprietary models and work developed in collaboration with western utility partners under prior grant award from the California Public Utilities Commission's California Solar Initiative (CSI). No utility customer, grid data or business sensitive information is released under this work and all information pertaining to the utilities and proprietary software remain the possession of the utilities.

**TABLE OF CONTENTS**

**1.0 INTRODUCTION .....5**

**2.0 APPROACH .....9**

2.1 MODELS AND DESCRIPTIONS ..... 9

    2.1.1 *Types of Simulation Models* ..... 9

    2.1.2 *Physical Model and Cluster Descriptions* ..... 10

2.2 EVALUATION CRITERIA AND ANALYSIS SCENARIOS ..... 15

    2.2.1 *Load Profiles*..... 15

    2.2.2 *Technical Criteria for Evaluation* ..... 18

    2.2.3 *Range of PV Penetrations & Scenarios*..... 20

2.4 MODEL ASSUMPTIONS AND INPUT DATA REQUIREMENTS ..... 24

    2.4.1 *Minimum and Peak Daytime Load Profiles* ..... 25

    2.4.2 *Validation Data and Process* ..... 27

**3.0 RESULTS – STEADY STATE.....29**

3.1 ELECTRICAL CLUSTER A EVALUATION RESULTS ..... 29

    3.1.1 *Electrical Cluster A Load Profiles* ..... 30

    3.1.2 *Electrical Cluster A Validation* ..... 31

    3.1.3 *Electrical Cluster A Results* ..... 34

    3.1.4 *Electrical Cluster A Summary* ..... 37

3.2 ELECTRICAL CLUSTER B EVALUATION RESULTS ..... 38

    3.2.1 *Electrical Cluster B Load Profiles* ..... 39

    3.2.2 *Electrical Cluster B Validation* ..... 41

    3.2.3 *Electrical Cluster B Results* ..... 42

    3.2.4 *Electrical Cluster B Summary* ..... 44

3.3 ELECTRICAL CLUSTER C EVALUATION RESULTS ..... 44

    3.3.1 *Electrical Cluster C Load Profiles* ..... 46

    3.3.2 *Electrical Cluster C Validation* ..... 47

    3.3.3 *Electrical Cluster C Results* ..... 49

    3.3.4 *Electrical Cluster C Summary*..... 51

3.4 APPLYING RESULTS TO QUANTIFY REMAINING CAPACITY ON FEEDERS ..... 52

**4.0 RESULTS – DYNAMIC ANALYSIS OF GENERATOR TRIP EVENT .....55**

4.1 ANALYSIS PROCESS ..... 55

4.2 INPUT DATA ..... 57

4.3 ANALYSIS PROCESS ..... 58

4.4 RESULTS AND ANALYSIS ..... 59

4.5 SUMMARY OF DYNAMIC CASE ..... 61

4.6 RECOMMENDATIONS ON CONTINUING EFFORTS ..... 61

**5.0 MITIGATION MEASURES .....64**

5.1 MITIGATION OPTIONS AND TRADEOFFS..... 64

5.2 OPTIONS APPLIED TO CLUSTERS ..... 70

    5.2.1 *Electrical Cluster C – Loading* ..... 70

5.2.2	<i>Electrical Cluster B – Fault Current Rise</i> .....	72
5.2.3	<i>Electrical Cluster A – Backfeed</i> .....	73
5.3	ASSESSING NEW DISTRIBUTED VOLTAGE REGULATING MITIGATION TECHNOLOGIES .....	80
5.3.1	<i>Low Voltage Model</i> .....	80
5.3.2	<i>Time-Step Analysis</i> .....	81
5.3.3	<i>Summary of Distribution Level Voltage Regulating Technology Analysis</i> .....	81
5.3.4	<i>Conclusions &amp; Recommendations</i> .....	82
5.4	USING PROACTIVE MODELS TO STRATEGICALLY SITE & INFORM DEMONSTRATIONS .....	83
<b>6.0</b>	<b>SUMMARY &amp; RECOMMENDATIONS</b> .....	<b>85</b>
6.1	FEEDER RESULTS AND STREAMLINING BENEFITS .....	85
6.2	NEXT STEPS.....	86
<b>7.0</b>	<b>REFERENCES</b> .....	<b>89</b>

## 1.0 INTRODUCTION

To adequately assess and stay ahead of high-PV penetration concerns on distribution feeders, the Proactive Approach has been developed to enhance planning models and incorporate inverter based information and distributed PV generators within the utility's baseline modeling and planning practice. A prescribed model validation process has also been introduced and described in prior reports [1, 2] for this effort to streamline the data gathering, model build, model validation and reporting process in support of studies including Interconnection Reliability Study (IRS) needs. While the Proactive Approach does not replace the IRS, through the Proactive Approach Methodology, a more transparent and consistent scenario-based analysis and reporting capability is available to help improve high penetration impact analysis for the electrical system and interconnection evaluations. Model, data and prioritization of feeder impacts form fundamental components of the Proactive Approach to conduct cluster evaluations for groups of feeders instead of the traditional one project at a time or one feeder at a time analysis and to be able to consistently "roll-up" distribution level impacts up to the system level. One of the biggest changes to traditional modeling introduced as part of Proactive Approach is modeling distribution resources as generators versus negative load. This enables future smarter functionality to be incorporated to help manage variability due to renewables; however, it also helps improve system reliability and provides cost savings by accounting for behind the meter generation. Hawaiian Electric Companies have enabled a REWatch capability to "see" behind the meter generation, and with a proactive modeling capability, can begin to more timely and effectively "manage" the higher penetrations of variable behind the meter generation.

The cluster evaluations conducted as part of a proactive modeling effort can be performed in anticipation of growth or new development and assess conditions and impacts. Results can be used to inform limits or other impacts that may need further analysis which are typically investigated as part of project IRS or more detailed design studies. To support the level of change resulting from high penetrations of distributed resources on the grid requires the following

- Enhanced modeling tools,
- Consistent screening and evaluation procedures,
- Common queue to prioritize studies, and
- Analysis capability to factor in new resource information and handle the increased volume of customer demand in a timely basis.

As part of grant funded initiatives, Hawaiian Electric Companies developed the Proactive Approach in partnership with western utilities and industry to establish a consistent process using enhanced modeling tools and transparent procedures for conducting high penetrations evaluations and respond to the growing need.

As part of the Renewable Standards Working Group (RSWG), established by the Hawaii Public Utilities Commission to assess recent changes and growth of renewables on the Hawaiian grids, the Proactive Modeling concept was unanimously recommended by the RSWG PV Subgroup for adoption as a viable pathway forward for utilities and the solar industry to develop proactive

planning practices and address DG impacts on the grid. Incorporating the process enables the ability to get a “heads up” on distributed generation conditions and when the conditions can impact transmission and system level operations.

Maintaining updated baseline simulation models and routinely conducting analysis will enable utilities to track changes and assess mitigation strategies in a timely fashion across the overall electric system instead of one project or circuit at a time. The modeling techniques and lessons learned from the Hawaii Proactive Approach are applicable to all utilities contending with challenges (planning, operating & mitigating) of future high penetration issues related to DG.

The objectives of the Proactive Studies include:

- Applying the cluster-based model organization and new variable resource data requirements for conducting high penetration analysis on distribution and transmission systems
- Identifying levels of PV penetration at which specific problems begin to occur for the distribution system;
- Using simulations to quantify remaining capacity in kW on existing distribution infrastructure and provide perspective on the potential of additional PV installations;
- Informing system impacts due to distributed PV through both steady-state and dynamic modeling analysis; and
- Evaluating and recommending mitigation options based on model evaluations.

This report focuses on real-world application of the methodology with simulation results for three Electrical Clusters: Electrical Cluster A – the Southwest region, Electrical Cluster B – Halawa region, and Electrical Cluster C – the West region, as shown in Figure 1.1. Each Electrical Cluster is comprised of interconnected substations (46kV to 12kV level) and associated 12kV distribution circuits. Results presented highlight 3 out of 12 Geographic Regions on Oahu.

These circuits were chosen because of the high penetration of PV, availability of utility data on majority of the circuits in the cluster for validation purposes and also based on the diversity of the types of customer loads on these circuits. These Electrical Clusters provide a good demonstration of the applicability of the Proactive Approach for different infrastructure conditions (i.e. types of customer loads, length of lines, data availability). As there are over 50 Electrical Clusters across the island of Oahu, a Data Verification Process was introduced as part of the Proactive Methodology, as described in Task 2.1 and Task 2.2 reports, to prioritize the clusters for analysis based on the completeness of data (Figure 1.2). At minimum, an appropriate simulation model, measured customer load information (e.g., residential, commercial, industrial) on circuits and field monitored solar data local to the area, constitute “Good” data suitable for Electrical Cluster analysis. Areas that lacked one or many of the data are placed lower on the list and identified for further field monitoring and modeling at a later time when data is available.

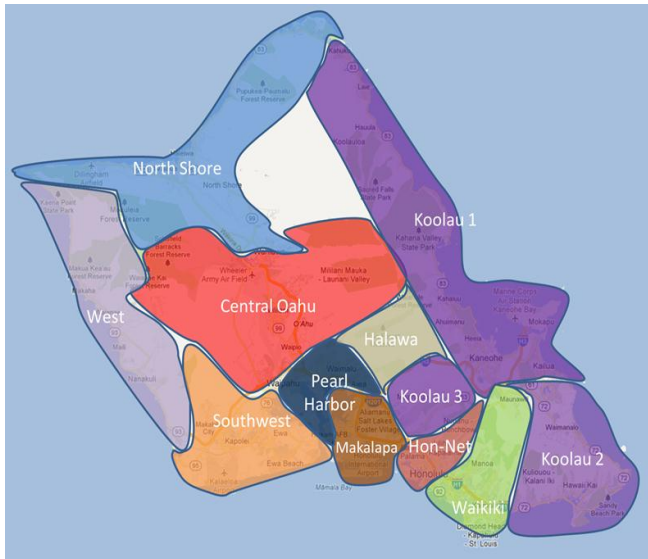

**Electrical Cluster A**

- Located in the Southwest Regional Cluster
- High Penetration PV
- Primarily Residential, some Commercial Customers
- Medium and Short Length Circuits
- Good Data Availability

**Electrical Cluster B**

- Located in the Halawa Regional Cluster
- High Penetration PV
- Residential, Commercial and Industrial Customers
- Medium Length Circuits
- Good Data Availability

**Electrical Cluster C**

- Located in the West Regional Cluster
- High Penetration PV
- Commercial and Residential Customers
- Medium and Long Circuits
- Good Data Availability

Figure 1.1 Three Electrical Clusters identified for Proactive Evaluation studies.

Electrical Cluster (46kV)	Regional Cluster	Model Available	Load Data	Solar Data
Cluster A	Southwest	Yes	Good	Good
Cluster B	Halawa	Yes	Good	Good
Cluster C	West	Yes	Good	Good
Cluster D	North Shore	No	Good	Good
Cluster E	Makalapa	Yes	Good	Limited
Cluster F	Koolau 3	Yes	Good	Limited
Cluster G	Waikiki	Yes	Good	Limited
Cluster H	Pearl Harbor	Yes	Limited	Moderate
Cluster I	Koolau 1	Yes	Moderate	Good
Cluster J	Koolau 2	Yes	No Data	Good

Figure 1.2 Excerpt of Electrical Clusters List organized by data priority.

The three Electrical Clusters highlighted in this report demonstrate varying levels of “Good” data. They will be used to show how the Proactive Analysis can provide early detection of critical



thresholds or impacts resulting from increasing penetrations of PV on the circuit, at the cluster level and even at the system level.

With consistent data and models, the Proactive Approach can progressively build on prior studies as new data becomes available to assess impacts and consider mitigations to address emergent needs. Completed Cluster studies can thus be used to provide proxy information or be used to inform conditions on similar circuits that currently have limited or no data.

This report documents the application of the Proactive Modeling process and showcases how simulations results can be used to track impacts and inform where monitoring and mitigation for high penetration PV is needed. Section 2.0 provides a detailed description of the overall approach in conducting the analysis and stepping through the analysis. High penetrations of distributed PV pose new requirements for traditional distribution modeling. As such, modeling enhancements, new data and analysis considerations are discussed including background on steady-state and dynamic analysis scenarios, description of the clustering approach to organize the grid, new data and validation requirements, technical criteria and assumptions and analysis process. These details are presented to give readers a glimpse into some of the considerations for running simulation models. Section 3.0 and Section 4.0 focus on the steady-state and dynamic results, respectively. Results are presented for the different cluster cases and scenarios. Results are also explained based on a set of high penetration evaluation criteria (both steady-state and dynamic) used to assess different grid conditions and recommend change given changing penetration levels. Insight on remaining capacity for the 4 clusters is also provided. Results for the 3 cluster evaluated provide one of the first attempts to quantify remaining capacity on the feeder and the associated criteria. Section 5.0 provides a discussion on different mitigation options, their pros and cons and considerations as applicable to conditions analyzed. While some mitigation recommendations are more near-term, such as monitoring needs, others require additional review and are provided as consideration options. Section 6.0 summarizes Benefits, Recommendations and Next Steps. The report also provides some recommendations on using the Proactive Approach as part of a routine process and using the results to conduct additional cost-benefit evaluations to consider alternative economic mechanisms and define strategies for integrating renewables. Section 7.0 provides other reference material related to the Proactive Approach to conduct high penetration analysis.

As utilities, Hawaiian Electric Companies are one of the utilities contending with some of the highest levels of distributed PV penetration and are actively working with other utilities like the Sacramento Municipal Utility District, and with support from industry, state and federal resources, to devise ways to assess and address change and enable cost-effective transformation strategies for electric customers. The Proactive Approach does not solve all the issues but hopefully it can provide the beginnings of a consistent framework and systemic process to organize data, prioritize through establishing thresholds, perform evaluations with appropriate models and communicate findings to inform decision-making.

## 2.0 APPROACH

The following sections describe what types of simulation models are used, what data inputs are needed, how the data is used in the analysis, how the model is validated, what data assumptions are made, which evaluation criteria are of concern, and how results can be used to inform decisions. As model simulation analyses are conducted, the results are processed for each distribution circuit to identify the technical conditions or criteria exceeded and at what level of PV penetration. Depending on the evaluation criteria, level of exceedance and existing infrastructure limitations, the results will provide guidance on distributed PV impacts on the system due to existing levels of distributed generation and shed insight on the future potential levels of distributed generation and mitigations.

By providing results for different thresholds or “hot spots” based on the analysis, the hope is that the value and benefit of future upgrades, mitigations or new distributed PV installations can be cost-effectively weighed.

### 2.1 Models and Descriptions

Standard industry electrical load flow modeling tools are used to conduct the high-penetration PV modeling analyses for the 3 Electrical Clusters. The models simulate how electricity flows through a circuit. As such, these models need certain input data containing detailed information on the existing utility infrastructure, including setting and limits. On the island of Oahu, the utility models contain information on the generators, the transmission infrastructure (138kV to 46kV level) and the distribution system (46kV to 12kV nominal levels and down to residential line voltages). Utilities maintain *baseline reference models and proprietary database* information representative of their service territory including generators, infrastructure (i.e., transmission, distribution, protection) and loading characteristics of their customers. These models are typically maintained and used by the utility planning departments.

#### 2.1.1 Types of Simulation Models

Simulation-based models are used to design and assess the system or any part of the network under different steady and time variant conditions, as introduced by those running the model(s). System network stability is one of the most important criteria for maintaining reliability and represents how stable the system will remain due to changes or disturbances. Models are used to represent the system’s response under steady-state and dynamic (time transient) conditions. The following are two types of simulations used in this analysis:

1. Steady state simulations capture the system equilibrium conditions or how stable the system is in response to small and slow changes. Most component design specifications are listed for steady-state operations. Steady state simulations thus look to model the output of PV systems on 1) a clear sunny day compared to 2) a cloudy day condition.
2. Dynamic analysis looks at time-variant and continuous change due to load or generation in normal and non-normal (contingency) conditions. Dynamic studies capture detailed change response over a period of time for the system ranging from faults (transients), recovery to normal conditions. For high penetration PV systems, dynamic simulations are useful to assess system response due to voltage, current and frequency change in transient

conditions (sub-seconds to seconds) or to ramp conditions lasting minutes to hours. Thus dynamic analysis is often the most data and model intensive. As such dynamic modeling requires very accurate model representations and validation data from the actual infrastructure including details such as relays, inverters, line impedances, switching, measured solar conditions and geographic locations.

- Transient simulations are a subset of dynamic analysis that looks at transitory or very short, time-variant change events such as a fault (i.e. line or generator). Transient stability studies for example, assess how quickly the system returns to stable conditions after a sudden fault or change over a prescribed time interval (ranging from sub-seconds to tens of seconds).

For the Proactive Analysis, the SynerGEE distribution model (for steady-state analyses) and PSS/E transmission model (for transient and dynamic analyses) are used to conduct simulations [3, 4]. Both the SynerGEE and PSS/E models are widely used, commercially available load flow models supported by software developers, DNV GL and Siemens, respectively. These models were chosen as they are being used by Hawaiian Electric Distribution and Transmission Planning staff and consultants for conducting distribution and transmission, steady-state and dynamic analysis. Both models have recently been enhanced, as part of the California Solar Initiative (CSI) and in partnership with DNV GL, to integrate distributed PV as generators versus simply as load reducers. Other dynamic simulation models such as PSCAD and CYME have also been used for specific transient studies at the distribution level, however the baseline reference models and validation data come from SynerGEE.

### 2.1.2 Physical Model and Cluster Descriptions

The Feeder Model provides a geographical layout of the distribution system, the equipment specifications and the connected loads on the distribution circuits. With high PV penetrations, the feeder models have also been enhanced to include individual residential roof-top distributed PV systems (Figure 2.1). The completed distribution feeder models and associated databases (one for distribution models and one for transmission model) are maintained by the utility within proprietary GIS mapping applications.

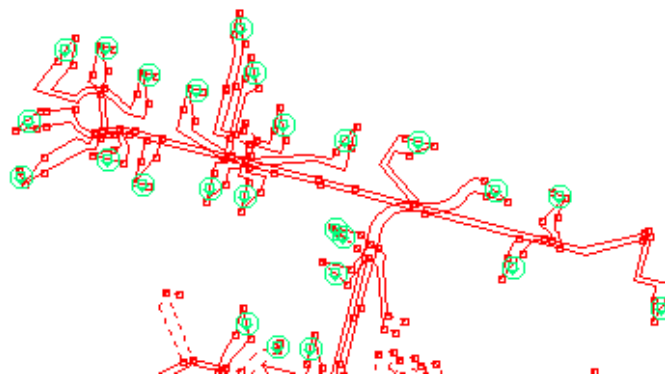

Figure 2.1. Detailed Feeder Model representation of a single distribution circuit and associated distributed roof-top PV systems shown in green.

As studies are conducted, areas of focus can be extracted for use in analysis models as illustrated in Figure 2.2. Studies are conducted using appropriate extracts of the associated sub-transmission and distribution feeders required for each study primarily to improve efficiencies and reduce the time it takes to run the full models.

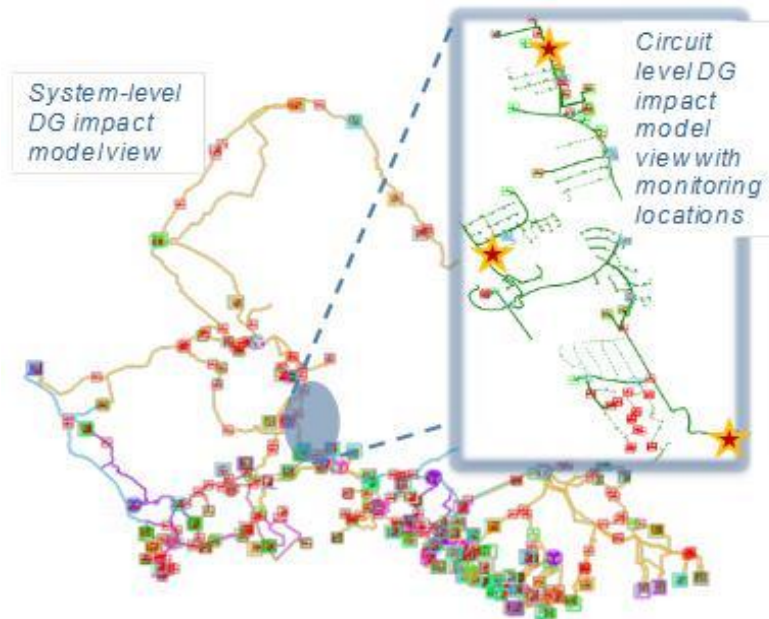

Figure 2.2. Graphical representation of the complete utility-owned distribution system and an extract of a cluster study area in callout box.

Figures 2.3 through 2.8 graphically depict the three Electrical Clusters for this study with and without PV. Within each electrical cluster, there are numerous individual 12kV circuits which are included in the analysis. Existing Generators represent currently connected PV and Additional Generators represent a queued list of PV applicants and future potential. The future potential is a modeling variable used to increase PV levels on circuits and conduct “what-if” scenarios.

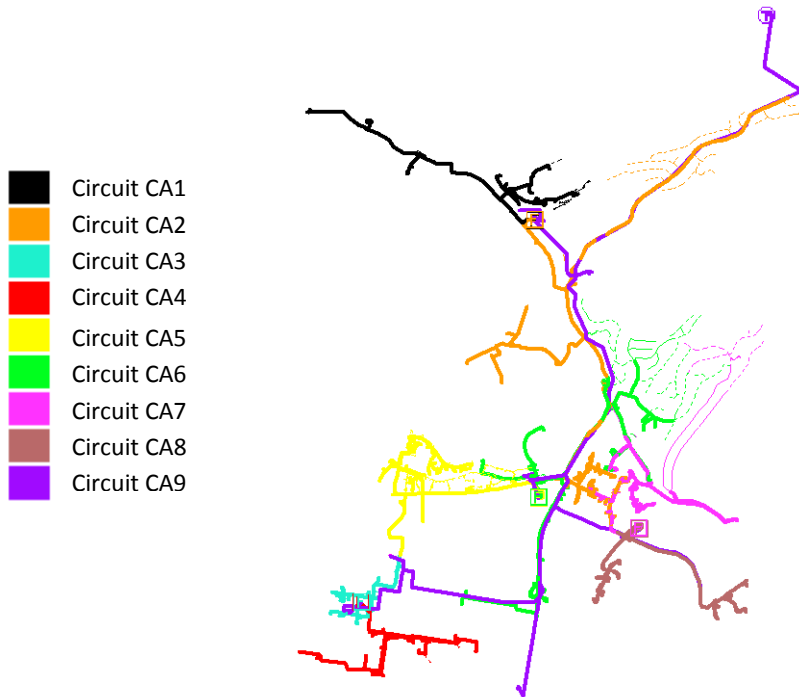

Figure 2.3. Cluster A Feeder Map.

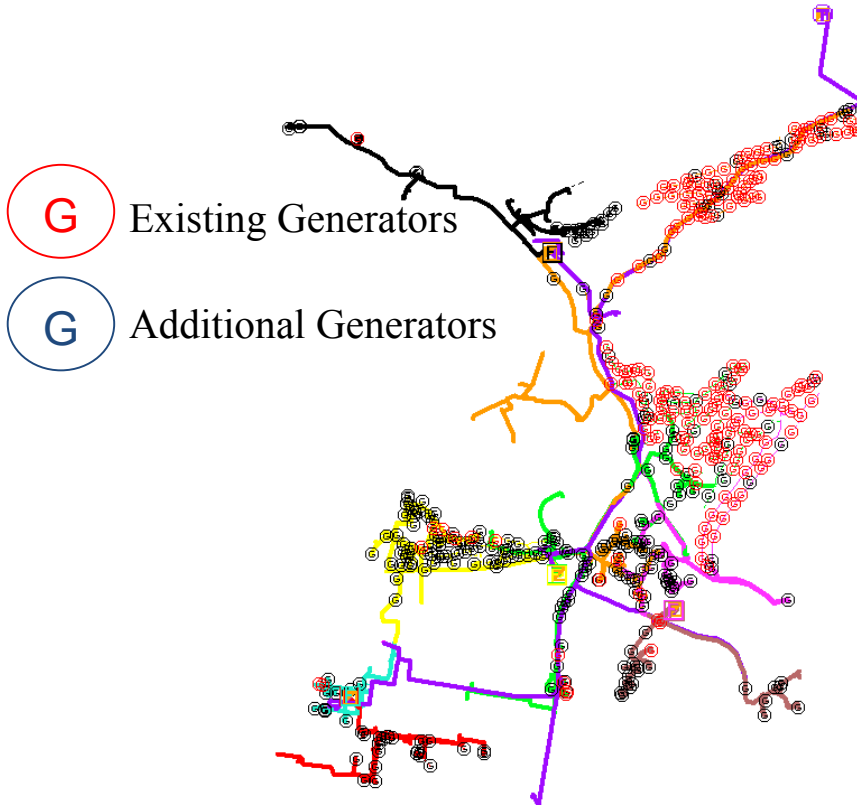

Figure 2.4. Cluster A PV Locations.

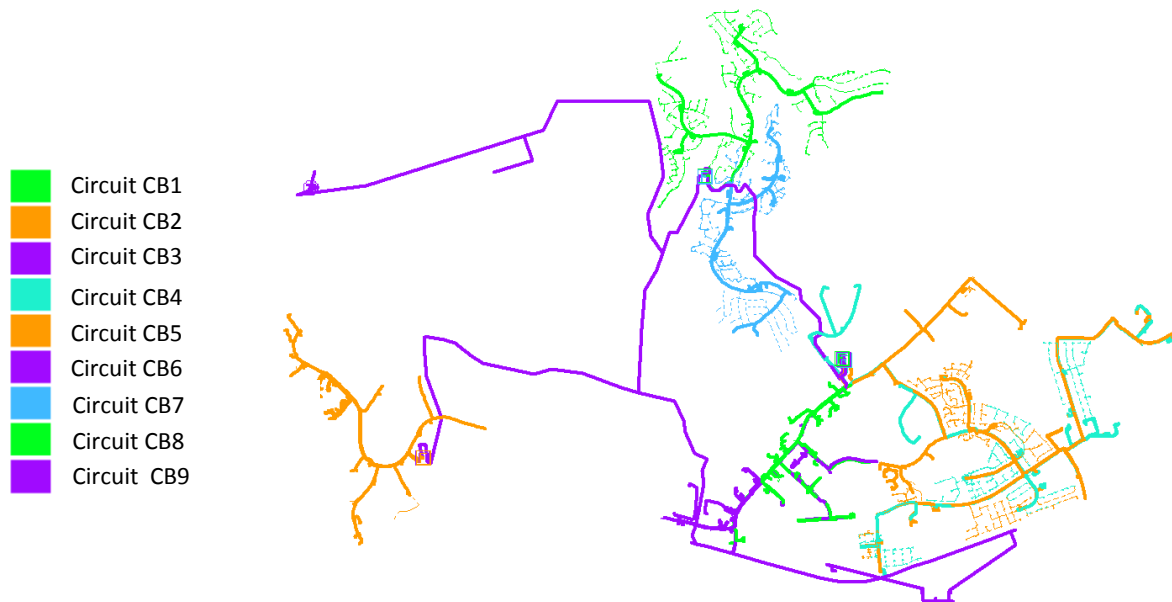

Figure 2.5. Cluster B Feeder Map.

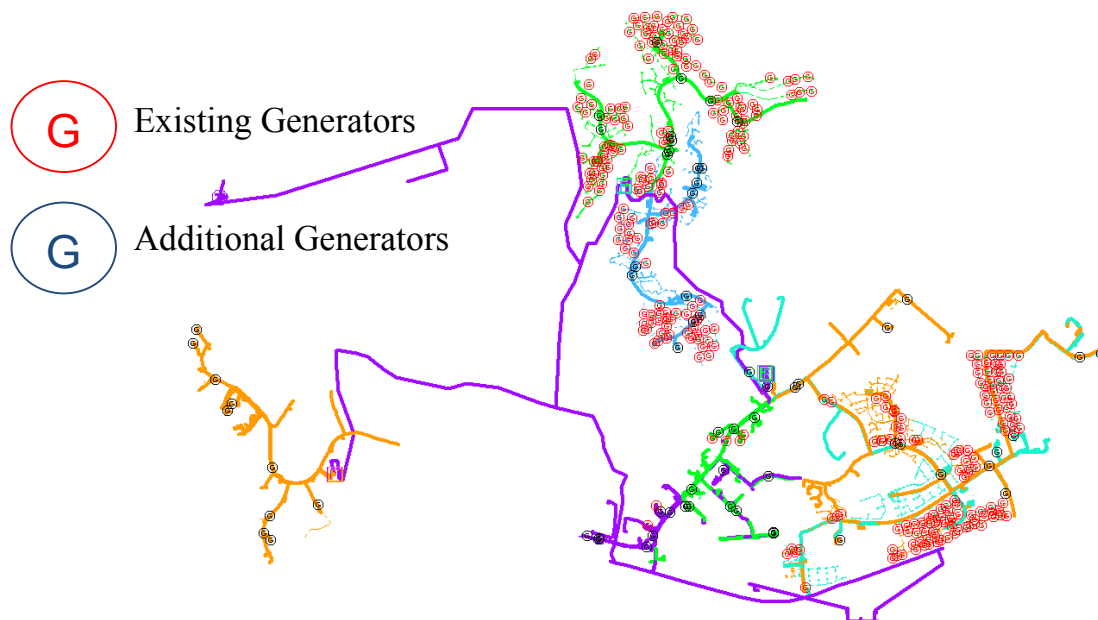

Figure 2.6. Cluster B PV Locations.

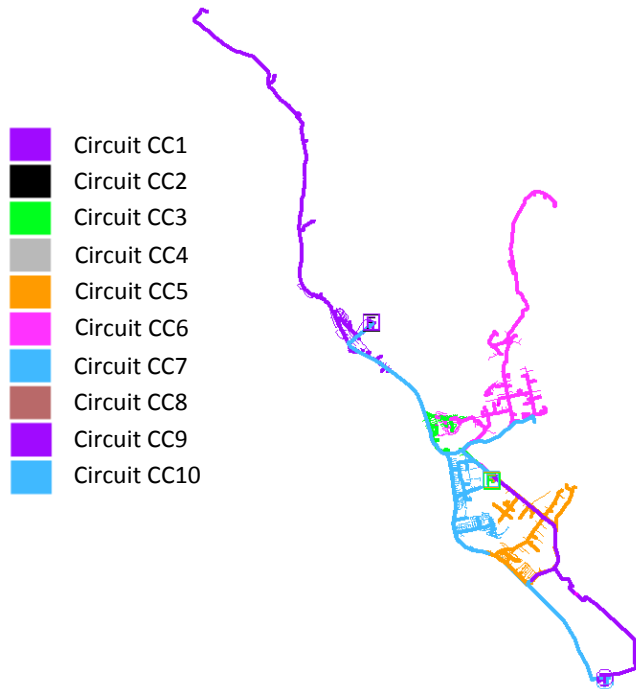

Figure 2.7 Cluster C Feeder Map.

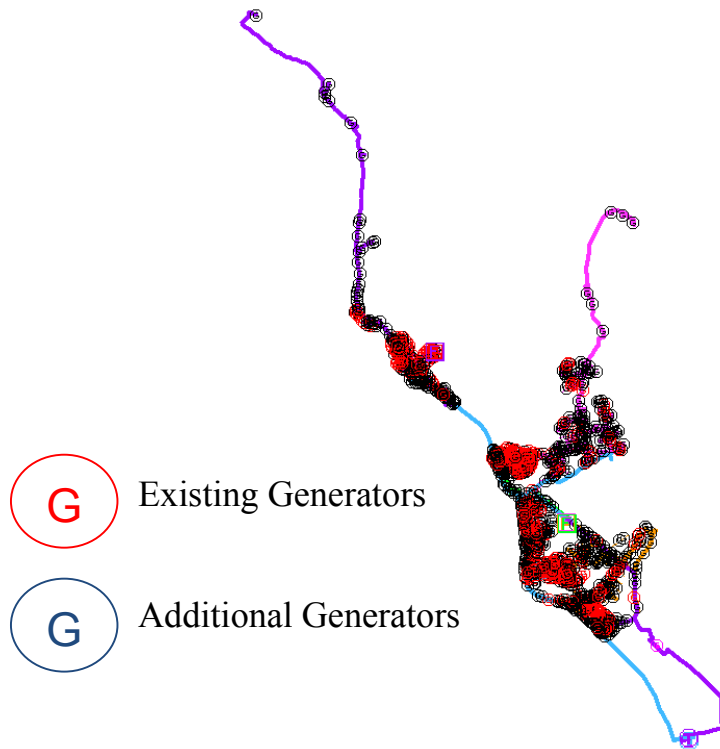

Figure 2.8 Cluster C PV Locations.

Once the Feeder Model is extracted, consistency checks are performed to verify that the model representation of the conditions on the feeder is accurate. Checks include

- Conductor and equipment specifications or closest equivalent representations exist in the modeling database;
- Sub-station connections and equipment are checked for connectivity and correct settings;
- Peak load analysis to double check for line loading violations and ensure appropriate conductor specifications being used; and,
- Levels of PV in the model match location and size by customer installation for feeder.

## 2.2 Evaluation Criteria and Analysis Scenarios

The method of analysis is designed in order to assess the integrated distribution and transmission system with respect to various evaluation criteria or conditions, for a number of different PV penetration levels. A number of different PV penetration scenarios are created and simulation runs conducted using the models. The scenarios are made up of different combinations of load profiles, installed PV capacity, and PV output (how much of that capacity is being generated). Sections below provide descriptive details for the feeder loading profiles, evaluation criteria, and range of PV penetration levels assessed.

### 2.2.1 Load Profiles

For modeling studies, analyses are typically conducted to account for worst case or extreme conditions based on historical load to be served. On distribution feeders, the planning focus is around the two extreme boundary cases:

- A condition of minimum loading on the feeder and the system
- A condition of peak loading on the feeder and the system.

As the impact of PV is of interest, Proactive Studies have included an additional study condition focused on the daytime load profiles, especially concentrating on times when the PV systems are likely to be operating at full output. Figure 2.9 shows an example of two feeders (Breaker A and Breaker B) that have peak loads during the morning (Breaker A around 9:30am) and daytime period (Breaker B from 6:40am to 4pm) which is non-coincident with system peak loads that occur around 7:30pm-8:00pm at night.

At first glance, customers on these feeders would benefit from installing PV to offset their demand during the day since their loads are coincident with the peak solar production during the day. However, upon further investigation, the weekend loads on these two feeders, even during the daytime, are significantly lower than the weekday loads on the feeder. If PV were installed to maximize production to meet customer demand (based on weekday loads), then every weekend, these feeders would potentially be backfeeding onto the transmission system. These feeders are already lightly loaded during the weekends; interconnection analysis would likely have to assess backfeed of excess solar generation onto nearby feeders, bi-directional monitoring and protection device impacts upstream of the distribution feeder. As such, proactively assessing cluster-level impacts would provide visibility to how the load profiles are changing from historical profiles due to PV penetration, how different load profiles can be depending on the type of loads on the feeders (residential, industrial, commercial), and how PV impacts different feeders.



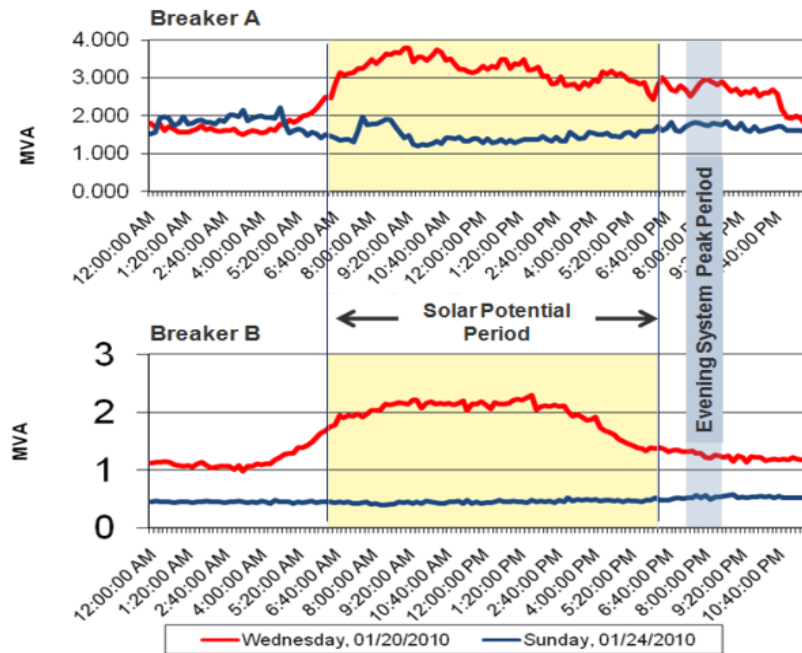

Figure 2.9. Feeder loading during weekday and weekend and compared to system peak.

Once the historical peak and minimum daytime load profiles are obtained, power flow analysis can be conducted using models like SynerGEE to model varying levels of PV (different scenarios) ranging from zero up to upper threshold of the historical peak conditions on the feeder. Results of simulations are presented in Section 3.0.

For purposes of this study effort, the upper threshold was selected at a high level at 135%, meaning the solar penetration on that circuit is 135% of the circuit’s peak load (in addition to several intermediate levels) so that adverse conditions would be encountered and the maximum allowable threshold could be identified by backing down to intermediate levels. Fault current analyses are also run at each of the specified PV penetrations. During a short-circuit fault, the resistance of the section of the circuit where the fault occurs is reduced to near-zero, resulting in a massive increase in the current – this increased current is known as the fault current. Fault current analysis is used to calculate the magnitude or size of the available fault current. Installation of PV inverters typically increases the available fault current, and it is important for the protection systems (such as circuit breakers) to be rated to operate with the maximum available fault current on the circuit.

As PV output changes throughout the day and can range from clear, cloudy and highly variable all in one day, clear day and cloudy day solar production profiles are also introduced. While simplified assumptions for clear day (100% production from PV systems) or some reduced production for cloudy conditions (20% production from PV systems) can be used for steady state (SynerGEE) analysis, actual PV irradiance and production profiles are needed for dynamic models (PSS/E) to capture variability of distributed PV resources across the island and to investigate impact of variability on system response. Figure 2.10 shows solar monitoring devices used by Hawaiian Electric to capture solar irradiance. Figure 2.11 shows an example of generation profiles from a single PV system used for modeling and validation needs.



Figure 2.10. Diverse field monitoring devices for measuring solar resource.

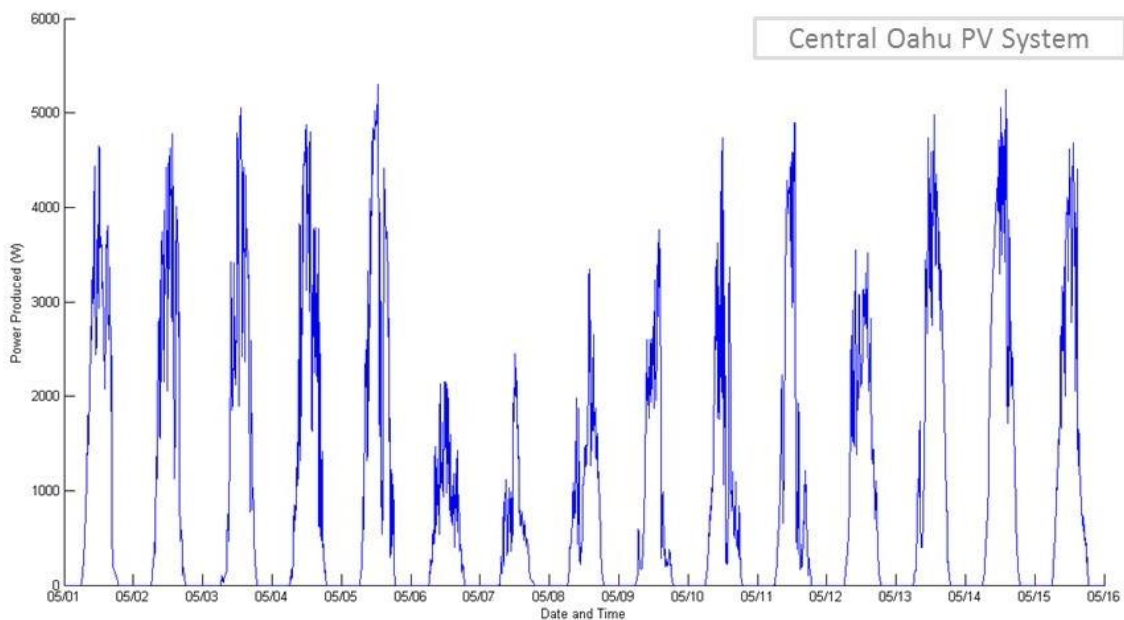

Figure 2.11. Solar PV system production profiles over a 2 week period.

For the Proactive Modeling Approach, in order to account for distributed PV within dynamic models, the individual roof-top PV systems on the feeders are aggregated as representative PV generators and modeled as generating resources versus negative load. Figure 2.12 illustrates how

the load (blue down arrow) and distributed PV (yellow circle) at the 12kV level can be aggregated as equivalent load and distributed generation onto to the transmission system (linkage shown in red).

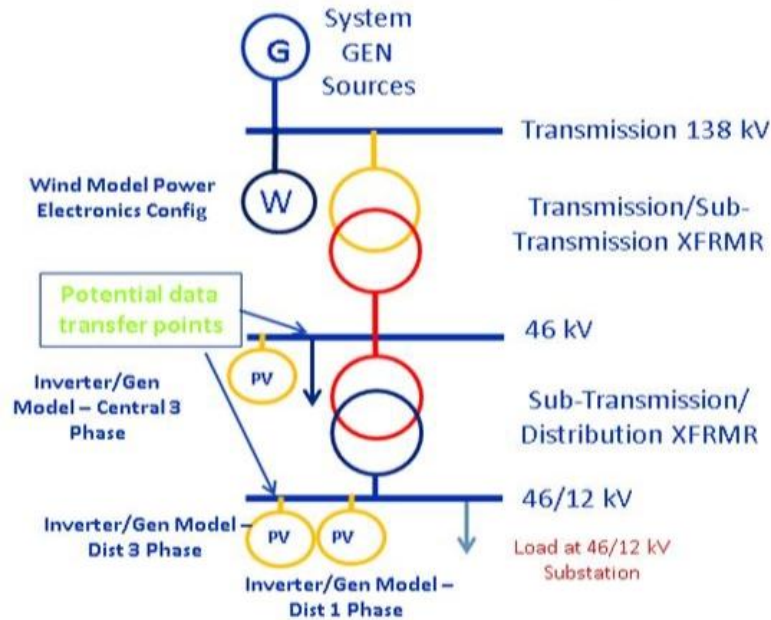

Figure 2.12. Modeling representation of equivalent load and aggregated distributed generation for transmission level analysis.

Time variant PV profiles representative of aggregated distributed PV generators can thus be incorporated and used to investigate impact of distributed PV on the system using the PSS/E model. Initial dynamic results presented in Section 4.0 provide insight on system and aggregated distribution level response under transient conditions (fault of line or generation) and N-1 contingency events. N-1 is a condition of a single failure of a line or generator on the system.

### 2.2.2 Technical Criteria for Evaluation

The evaluation criteria (or Technical Criteria) described in this section are used to identify conditions or issues that impact the grid which may preclude additional PV penetration onto the circuits. Technical Criteria are defined based on a technical problem that would be caused on the electrical system with increasing levels of exceedance.

For steady-state analysis, Table 2.1 lists the Technical Criteria, associated limits and associated effects and impacts. Table 2.2 lists the Technical Criteria pertaining to dynamic modeling analysis conducted as part of this report.

Table 2.1. Technical Criteria for Steady-State Analysis.

Technical Criteria	Limit	Effects and Impacts
<b>Backfeed</b>	Reverse power flow as output of distributed generation exceeds feeder load	Existing distribution system equipment (such as transformers) have control systems that are set up to handle power flow in one direction only – from the transmission system through the distribution system to the customer. When power flow reverses at the transformer, the existing control systems may not recognize the change in direction and only sense the magnitude of the power. This can result in voltage regulation equipment moving in the wrong direction, causing increasing voltage problems.
<b>Load Tap Changer (LTC) Position</b>	Change in LTC position due to variation in PV output between 100% - clear day and 20% - cloudy day	The LTC is a voltage regulation device integrated into the transformer. In order to maintain the voltage on the distribution system within a specified band-width, it can increase or decrease the transformer voltage ratio incrementally when system load or generation conditions change. If the number of LTC position changes increases, this can cause a decrease in the service life of the equipment, and require more frequent maintenance or replacement.
<b>Thermal Loading</b>	Line loaded over 100% of specified capacity	If a line section is overloaded it can over-heat, causing potential damage to the equipment itself or surrounding structures.
<b>Voltage</b>	Voltage at any point on the distribution system is less than 95% or greater than 105% of nominal.	Customers would experience high or low voltage problems which can damage appliances and service may be lost if voltage remains outside nominal $\pm 5\%$ .
<b>Fault Current</b>	Short circuit contribution ratio of all generators connected to the distribution system is greater than 10% (California Rule 21 and Hawaii Rule 14H criterion) or 5% (Hawaii internal criterion).  The two criteria given trigger more detailed studies of protective equipment capacities. The 10% value comes from the Electric Rule No. 21 document, while the 5% value is a limit that	Increases in fault current may require upgrading of protective equipment on the system. Circuit breakers at the sub-stations are rated for a maximum level of fault current, and if this value is exceeded the breakers may not function as required, causing damage to equipment and required replacement.

has been communicated to DNV GL by HECO in previous projects, likely due to some of their distribution circuits being more sensitive to increases in fault current.

Table 2.2. Technical Criteria for Dynamic Analysis.

Technical Criteria	Limit	Effects and Impacts
<b>Under Frequency Inverter Trip</b>	During an N-1 analysis, additional load shedding occurs compared to event occurring with no PV installed.	If PV inverters trip due to under-frequency during a transient event, this can lead to a cascading loss of generation, to which the electrical system responds by shedding load (blackouts) in order to balance the load with the reduced available generation.
<b>Over Voltage Inverter Trip</b>	During an N-1 analysis, additional load shedding occurs compared to event occurring with no PV installed.	As above, during a rapid reduction in generation due to inverters tripping, the voltage may increase, which again can be alleviated in the short term by the electrical system shedding load.

Technical Criteria define the adverse conditions that would result on the electrical system due to exceedance of the described limit and the resulting effects/impacts. For example, backfeed occurs when the output of distributed PV exceeds the customer demand or load on the circuit and may require upgrades to install bi-directional monitoring devices to detect power flow reversals and reviews of proper response from voltage regulating devices, if the backfeed situation cannot be mitigated in another way. Through simulation-based modeling of an increasing range of PV levels, the threshold of backfeed condition on circuits can be determined, a priori, so monitoring devices and assessments can be proactively performed.

### 2.2.3 Range of PV Penetrations & Scenarios

For both the steady-state and dynamic analyses, scenarios are established and used to run the models. The scenarios are a means of capturing a variety of conditions of interest with varying degrees of sensitivity between the different conditions. The Proactive Approach Modeling methodology was developed to identify a list of scenarios that would capture all major conditions on the grid rather than developing a new custom list for each study. With automation introduced into the modeling runs, covering an extensive list of conditions does not have a significant impact on the time it takes to complete the analysis.

The different scenarios for each of the steady-state parameters are shown in the Table 2.3. Note, the analysis is carried out up to 135% of peak load as a modeling criteria and not necessarily indicating that 135% of peak load can be interconnected. This is an extreme level with the

intention of creating an adverse issue and then backing down to identify at what penetration level begins to create the condition.

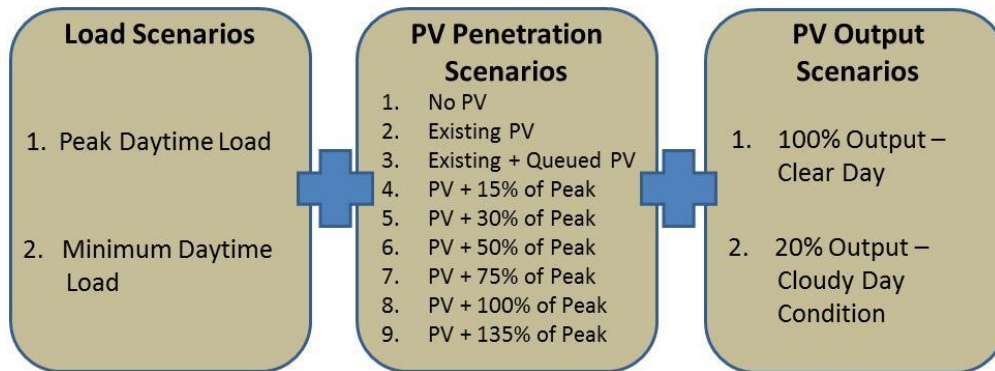

Figure 2.13. Scenario Combinations

By forming all possible combinations of the above options, 34 steady-state cases are defined as listed in Figure 2.13. Note that the existing PV and queued PV penetration levels vary by individual circuit and can vary from 0% to 135% of peak load, and for some circuits even higher than 135% of peak load. Though many of the circuits already have existing installed PV, a “No PV” scenario is created to establish a common baseline for comparison between “No PV” and the “Existing PV” scenarios. “Existing + Queued PV” accounts for another gradation of PV installed on the feeder and accounts for known and approved to be installed PV on the circuit. “PV + 15% of Peak” through “PV + 135% of Peak” identify a systematic range of increasing PV on the feeder. Analyzing the range of scenarios provides planners better understanding for which feeders within the cluster begin to exhibit change first, at what level of PV do exceedance levels begin to occur given the Technical Criteria and what happens at extreme exceedance levels (hopefully attained at or near 135%). The scenarios allow planners to simulate the response of the system at high penetrations, without actually exposing the system to any risks and to consider appropriate and cost-effective mitigation measures that have the most value in resolving conditions for both distribution level and system levels.

Table 2.3. Scenario Definitions.

Case Name	Load Profile	Installed PV Penetration (% of Peak Load)	PV Output
Case 1	Peak	0%	0%
Case 2	Min	0%	0%
Case 3	Peak	Existing	100%
Case 4	Min	Existing	100%
Case 5	Peak	Existing	20%
Case 6	Min	Existing	20%
Case 7	Peak	Existing + Queued	100%
Case 8	Min	Existing + Queued	100%
Case 9	Peak	Existing + Queued	20%
Case 10	Min	Existing + Queued	20%
Case 11	Peak	15%	100%

<b>Case 12</b>	Min	15%	100%
<b>Case 13</b>	Peak	15%	20%
<b>Case 14</b>	Min	15%	20%
<b>Case 15</b>	Peak	30%	100%
<b>Case 16</b>	Min	30%	100%
<b>Case 17</b>	Peak	30%	20%
<b>Case 18</b>	Min	30%	20%
<b>Case 19</b>	Peak	50%	100%
<b>Case 20</b>	Min	50%	100%
<b>Case 21</b>	Peak	50%	20%
<b>Case 22</b>	Min	50%	20%
<b>Case 23</b>	Peak	75%	100%
<b>Case 24</b>	Min	75%	100%
<b>Case 25</b>	Peak	75%	20%
<b>Case 26</b>	Min	75%	20%
<b>Case 27</b>	Peak	100%	100%
<b>Case 28</b>	Min	100%	100%
<b>Case 29</b>	Peak	100%	20%
<b>Case 30</b>	Min	100%	20%
<b>Case 31</b>	Peak	135%	100%
<b>Case 32</b>	Min	135%	100%
<b>Case 33</b>	Peak	135%	20%
<b>Case 34</b>	Min	135%	20%

For each of these cases, 24 steady-state load flow analyses are performed to represent a six-hour segment of the day – 10am to 4pm – split into 15-minute intervals. For each of these time-steps, only the load value was changed, the installed generation and the generator output remained fixed at their specified values. The 24 cases are used to assess the different Technical Criteria (conditions) as described in Table 2.1. Table 2.4 provides a description of the compliance and exceedance levels for each of the Technical Criteria listed in Table 2.1. Descriptions further elaborate on the degree of severity and analysis treatment if the Technical Criteria is exceeded.

Table 2.4. Compliance with and Degree of Exceedance with Respect to the Technical Criteria.

Technical Criteria	Assessment of Degree of Exceedance of Technical Criteria
Backfeed	<ul style="list-style-type: none"> <li>The backfeed study is performed by identifying the minimum daytime load on the feeder. As it is assumed that the PV output could be at 100% at any time between 10am and 4pm, this minimum load represents the PV penetration at which reverse power flow may occur.</li> <li>Backfeed results are reported both at the feeder level and at the transformer level. On the Hawaiian Electric system, each distribution transformer may have from 1 to 3 distribution feeders connected, and there may be the situation where one of these feeders' experiences reverse power flow at the feeder head while the others</li> </ul>

	do not. In this case there may still be voltage control issues on the feeder with reverse power flow, even though there is not reverse flow through the transformer, and as such it is important to be aware of when this condition may occur. The case where there is reverse power flow at the transformer is a more obvious problem as the voltage regulation systems must then be set up to recognize the direction of power flow and act accordingly.
LTC Cycling	<ul style="list-style-type: none"> <li>In order to identify any LTC Cycling violations, for each load and PV penetration case the PV generator output is varied between 100% and 20%. For the same time-step (and therefore same customer load) the LTC position is compared for the two different PV outputs. As all other parameters remain the same, any change in LTC position can be attributed solely to the change in output of the PV generators connected to the circuit. If the LTC position changes, this constitutes a violation.</li> </ul>
Thermal Loading	<ul style="list-style-type: none"> <li>For each load flow analysis performed, the maximum continuous current on each feeder is calculated. Again, the first two cases are checked first to ensure that the customer load alone is not causing load violations. After these are verified, the maximum continuous loading on the feeders for all the other cases is calculated. If the continuous loading is above 100% on any section, this constitutes a violation. As with the voltage results, if a violation is found then the location and reason for the violation (if it is identifiable) is identified and presented.</li> </ul>
Steady-state Voltage	<ul style="list-style-type: none"> <li>For each load flow performed, the maximum and minimum voltage on each feeder is calculated. If these values are within the range 95% to 105% of the nominal voltage then there is no violation. If either the maximum or minimum voltage is outside this range, there is a violation. If the violation occurs in either case 1 or case 2 in Table 2.1.3 above (when there is no PV installed), then the model is checked to identify any inaccuracies as it is generally assumed that there should not be any voltage violations in an existing condition.</li> <li>If voltage violations occur outside of the first two cases, the location of the violation is identified and presented.</li> </ul>
Fault Current Rise	<ul style="list-style-type: none"> <li>The fault current rise study is performed by comparing the maximum fault current for each PV penetration scenario to the maximum fault current when no PV is installed. The results are important for protection systems coordination, and there are two criteria checked: 5% fault current rise (from no-PV condition) and 10% fault current rise (from no-PV condition).</li> </ul>

For high penetration PV, many of the traditional “rules-of-thumb” for compliance and exceedance levels may need to be reconsidered and will take time to evaluate. Planning studies such as these are being conducted by a number of utilities across the world and helping to inform standards development as the electrical grid transforms to accommodate a more diverse generation portfolio. Efforts are also currently underway by the Institute of Electrical and Electronic Engineers (IEEE), Federal Energy Regulatory Commission (FERC) and Underwriters Laboratory (UL) to revise standards that accommodate high levels of variable, distributed resources.



## 2.4 Model Assumptions and Input Data Requirements

The following assumptions are implicit in the cluster study process:

1. PV generation will grow in areas where there are existing customers;
2. Transformer and other voltage regulation equipment settings remain constant;
3. All installed PV generators were functioning and output was directly proportional to measured irradiance during the period of load measurement; and,
4. 100% output of installed PV could occur at any time between 10am and 4pm on any given day.

Table 2.5 shows the data requirements for each of the Technical Criteria identified in the Table 2.1.

Table 2.5. Data Required for Technical Criteria.

Technical Criteria	Data Required
Backfeed	Minimum load value in kW.
LTC Cycling	Peak and minimum load profiles, sub-station data to allow transformer operation to be validated.
Thermal Loading	Peak and minimum load profiles, and feeder model with conductor and other equipment specifications in order to identify current-carrying capacity.
Voltage	Peak and minimum load profiles, feeder and equipment data, sub-station data to allow transformer operation to be validated.
Fault Current Rise	Feeder model with equipment ratings and electrical properties.

In some cases there may be insufficient data on feeders to conduct all these analyses.

- Where feeder measured load data is unavailable, the feeders have been identified and prioritized for monitoring to ensure that actual data will be made available in the future, especially for critical circuits (e.g. feeders with large amounts of PV).
- Depending on the urgency of need, proxy analysis using data from a similar type of feeder can also be used, however for purposes of this present report and within given time constraints, feeders with no measured load data are marked for later analysis. While this precludes conclusions to be drawn on that feeder, evaluation can still proceed as part of the cluster evaluation and as information becomes available for the feeder, analysis can be included.

For Oahu, there are circuits for which an accurate Feeder Model is unavailable or incomplete to the utility due to the feeder being owned by a specific customer and the layout being confidential (such as at the Department of Defense military installations and the University of Hawaii at Manoa campus). In these cases, utility assumptions are made to model the feeder as a single line section of a certain length, with equivalent generators and a load.

- Where feeder models are unavailable, there is no immediate intention to create models for these feeders as they are customer-owned. These cases are identified in the cluster analysis results in Section 3.0 of this report.
- Additional detailed modeling is typically not recommended until more information for the feeder can be provided.

#### 2.4.1 Minimum and Peak Daytime Load Profiles

As discussed in Section 2.2.1, for the cluster analysis, it is required that a minimum daytime load profile based on historical data from the feeders be identified, as well as the peak daytime load profiles for each cluster. In this case, 'daytime' refers to the period between 10am and 4pm where the PV output could be at 100% production. This cluster profile development produces a 24 hour load profile presented in 15-minute intervals resolution. For initial analysis, the data was screened for days with missing data and unusual load switching – resulting in non-representative high demand on the circuit (Figure 2.6).

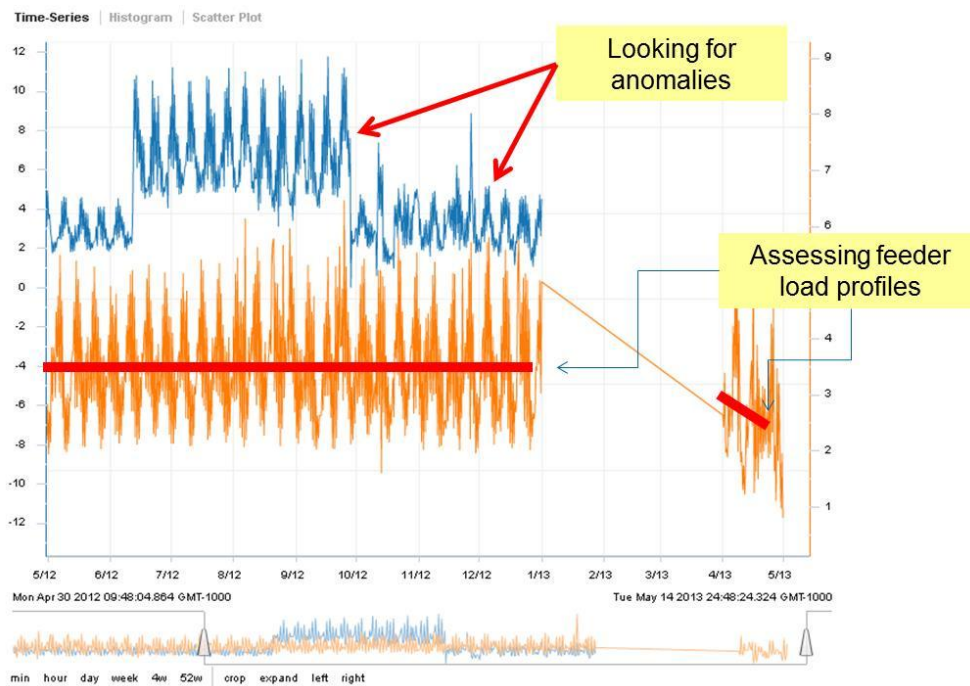

Figure 2.6. Example of load switching on the feeder where load was unusually high for a short period of time.

The load profiles are intended to represent the total energy to supply customers. The demand data is what is measured at the substation and is effectively the net load or actual energy supplied by the utility to the customers. With more PV production on a circuit (sunny day), the net load or demand measured at the substation decreases since part of the demand is served by local generation from roof-top PV. As production of electricity from PV on the circuit decreases (such as on a cloudy day with less solar resource), demand measured at the substation will increase.

The normal process of obtaining the load profile is to start from the demand data (measured at the substation) and add the estimated output from the PV generators on the circuit based on locally measured irradiance for the same period. Figure 2.7 shows an example of how the load, demand, and the load masked by the PV are related.

In this chart, the blue area represents the ‘demand’, which is the load measured at the substation. The green area represents the estimated PV generation profile on the feeder for the day in question, which masks some of the actual load used by the customers. The red line represents the actual load used by the customers connected to the circuit, obtained by adding the masked load to the demand measured at the substation.

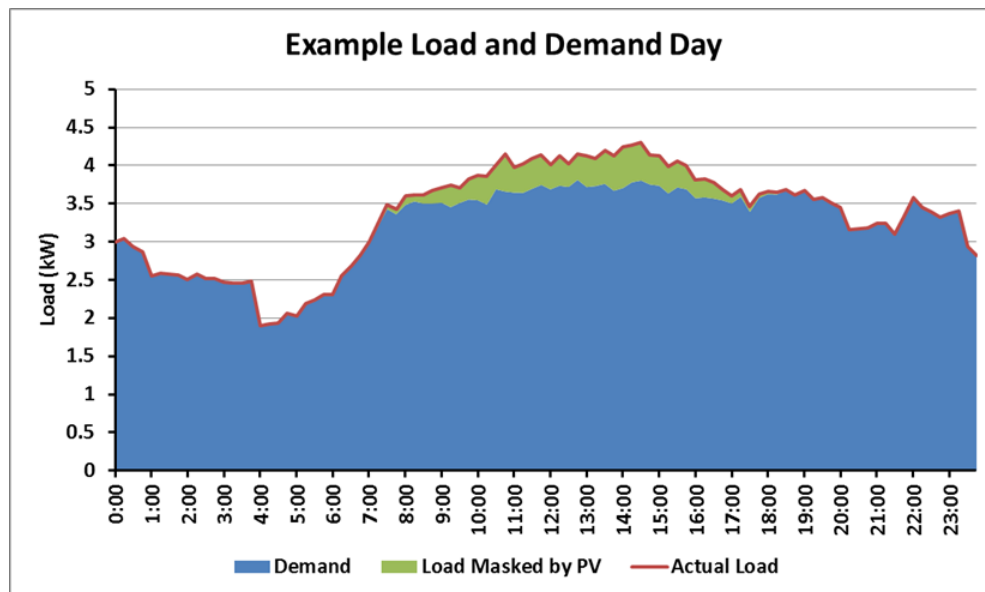

Figure 2.7. Profiles of Total (Actual) Load, Demand (Net Load) and Load Masked by PV.

Demand data is measured by the utility based on coverage of their SCADA (Supervisory Control And Data Acquisition) and monitoring devices and telecommunication services. Traditionally, not all distribution feeders (12kV) are directly or individually measured. For some of the feeders with no monitored data, an estimate of the load on these feeders can be made by taking the summation of all feeder demand served at the 46kV level (which is monitored by SCADA) and subtracting all known 12kV feeder demand on the 46kV line, leaving the remaining demand on the feeders without measurement. Thus, this remaining demand is allocated to the remaining feeders in proportion to their historical peak load values. Peak loads are determined for each circuit on an annual basis by the utility and is derived from the SCADA data where available. For circuits without any SCADA information, temporary monitors are sometimes used to collect the load data for a short period of time to periodically assess conditions.

With higher PV penetrations, there is a growing need to deploy monitoring and categorize the feeders by customer load types to accurately assess impacts and track change. For the purposes of this report and within the given timeframe of analysis, feeders without SCADA data or ability to derive using the summation of feeders, are identified for monitoring and later analysis.

#### 2.4.2 Validation Data and Process

Data is required to verify that the results obtained from the analysis in the model are consistent with those that occur in real life. The parameters that can be checked are the voltage and the transformer LTC (Load Tap Changer) position. In order to check these results, data for a one-day profile of demand (kW, kVAR and kVA), voltage measured at the transformer and the transformer's LTC position are desired. This data is used to validate the operation of the transformers.

Validation data is used to check that the transformer is set up correctly and that the voltage (and LTC position data, if available) is correct for a given input demand. The first step in this validation process is to check the transformer Line Drop Compensation (LDC) settings. LDC is the control process used on an electrical system to ensure that the voltage at the end of the circuit is within an acceptable range. The acceptable range is defined as the LDC voltage set-point, plus or minus a specified band-width. As the length of the circuit increases, the voltage at the end of the circuit drops due to electrical losses in the conductors. In a traditional distribution system, the voltage is only measured at the transformer, so the LDC system is used to calculate the approximate voltage at a specified point in the circuit (usually the end). The LDC system can then instruct the voltage regulation equipment at the transformer to adjust the voltage up or down in order to compensate for the drop in voltage along the circuit.

The objective of the validation analysis is to ensure that, for a given load profile on the circuit, the voltage regulation equipment produces the correct corresponding voltage at the transformer.

To perform the validation analysis, the load on the system is first adjusted such that it is within an acceptable range of the measured value provided by the utility.

Once this is achieved, the voltage is checked against the measured value. In this case, the voltage is to be within the LTC band-width of the measured value. As no band width is given for the HECO transformers, this is normally selected as 0.75V (on a 120V base), which is the smallest band-width available in SynerGEE. The reason for selecting the smallest band-width is that this ensures that the LTC will change position most frequently, and thus represents a conservative assumption with regard to the LTC Cycling criterion described earlier.

If the analyzed voltage is not within the acceptable range for the given input demand, the LTC voltage setting is adjusted to find a setting that would produce acceptable results. Any changes to the specified voltage settings are noted in the validation reports. Once the voltage is checked, the LTC position is also checked (if the data is available). The criterion for this is that the analyzed LTC position should be within one step of the measured position.

For cases where validation data is presently unavailable for voltage or LTC position at the transformer, or where the operation in the model could not be validated following the described process, the results are not provided at this time. As part of this comprehensive review process, these circuits with insufficient data for validation are flagged for priority monitoring. The consequence of circuits with insufficient validation data is that further PV connection may be delayed due to uncertainty and inability to model and assess the feeder(s) condition. The engineers responsible for approval of PV applications will have less data available to carry out their work. Ultimately, if the limits to PV connection are unknown, more conservatism will be needed to manage unforeseen problems. To reduce integration risks and manage high penetrations, it is

important that sufficient distribution level data be gathered and reviewed timely especially for areas where there is high demand for more PV interconnection.

### 3.0 RESULTS – STEADY STATE

This section presents the results of the steady-state analysis for three Electrical Clusters on Oahu. As shown in Figure 1.1, the three clusters are considered high penetration, have a diversity of customers (residential, commercial and industrial) and feature line lengths that range from short to long.

- Electrical Cluster A: Southwest Region , primarily residential, mix commercial
- Electrical Cluster B: Halawa Region, mixed residential, commercial and industrial
- Electrical Cluster C: West Region, primarily commercial, mix residential

Steady state analysis is used to evaluate how stable the system is due to slow and steady change conditions over the course of the day. For each of the clusters, a general description of the circuit, data availability and any missing data is provided and discussed. While not all circuits will have complete data, sufficient data is necessary to conduct validation checks and establish a confidence level for the conditions simulated and technical limits identified. Successful validation of basic parameters such as the demand and voltage provide a sense of confidence that the modeled results reflect reality. When validation parameters are outside validation range, there may be uncertainty in the model or the quality of the data which warrants further investigation. Through the Proactive Approach process, distribution feeders can be evaluated and validated. Results are also presented in a consistent fashion – graphical and tabular formats are presented for each cluster to facilitate analysis and also to compare results from one cluster to another. For each cluster, this report will provide the following:

- 1) Peak and minimum loading profiles for each feeder
- 2) Results of the validation and issues identified
- 3) Technical thresholds on feeders and existing PV levels
- 4) Summary of results

#### 3.1 Electrical Cluster A Evaluation Results

Electrical Cluster A represents a typical group of feeders serving primarily residential customers. Located in the Southwest Region this area has good solar resource. The analysis covered 8 feeders (CA1 through CA8) serving this community, representing short to medium in length (within 1 mile in length) connected to 4 separate transformers (TA1, TA2, TA3, TA4). Table 3.1 presents the distribution circuits included in the analysis, the transformer they are connected through, the SLACA (historical peak load) value and the existing and queued PV generation on the circuit. Table 3.2 shows which data was available for the distribution circuits included in the study.

Table 3.1 Electrical Cluster A Distribution Circuit Data.

Distribution Circuit	Transformer	SLACA (kW)	Existing PV (kW)	Queued PV (kW)
CA1	TA1	1062	312	0
CA2	TA1	3531	1244.67	0
CA3	TA2	3007	127.75	240
CA4	TA2	520	0	0
CA5	TA3	4106	51.45	180
CA6	TA3	2628	844.34	0
CA7	TA4	1688	361.6	0

CA8	TA4	2412	288.94	200
-----	-----	------	--------	-----

Table 3.2 Electrical Cluster A Data Availability.

Feeder	SCADA/BMI	Feeder Model	Validation Data
CA1	Yes	Yes	Yes
CA2	Yes	Yes	Yes
CA3	Yes	Yes	Yes*
CA4	Yes	Yes	Yes*
CA5	Yes	Yes	Yes*
CA6	Yes	Yes	Yes*
CA7	Yes	Yes	Yes*
CA8	Yes	Yes	Yes*

\* LTC data not available, only voltage data for validation

Based on the data review, not all feeders have sufficient measured data to complete the different analysis. In this case as a number of the feeders do not have LTC data for validation, thus the LTC position results will not be reported. For feeders with available data, if validation is successful, the following results will be provided.

- CA1, CA2      All results are reported
- CA3 to CA8      Backfeed, Loading, Voltage and Fault Current Rise results reported, no LTC results presented

### 3.1.1 Electrical Cluster A Load Profiles

Figure 3.1 shows the loading profiles on the different feeders on Cluster A for a minimally loaded day (minimum load day). Figure 3.2 below shows feeder loadings on a highly loaded day (peak load day). The profiles are shown over the 10am to 4pm period of analysis for high penetration conditions. Graphically, these feeders can be reviewed for highest loaded feeder, lowest loaded feeder, most peaky load feeder and feeder with limited change between minimum and peak load conditions. For example, the average loading on feeder CA3 changes from about 3 MW minimum loading to over 5 MW at peak loading conditions. Feeder CA2 has loads that exhibit a “peaky” load which may be indicative of customer loads that have a lot of on-off conditions. Other feeders like CA5 remain relatively steady in terms of loading around 3 MW in either minimum or peak conditions.

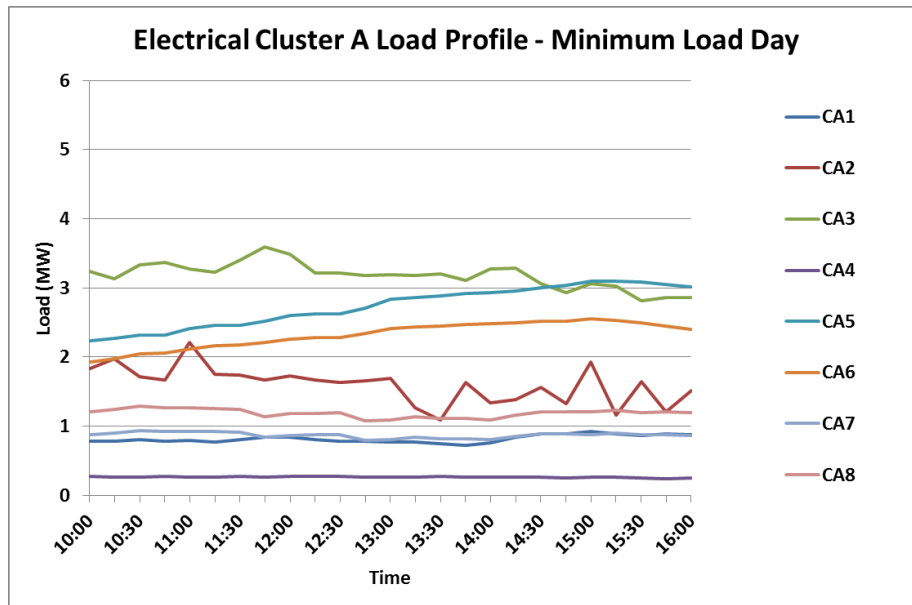

Figure 3.1. Electrical Cluster A Minimum Load Profiles.

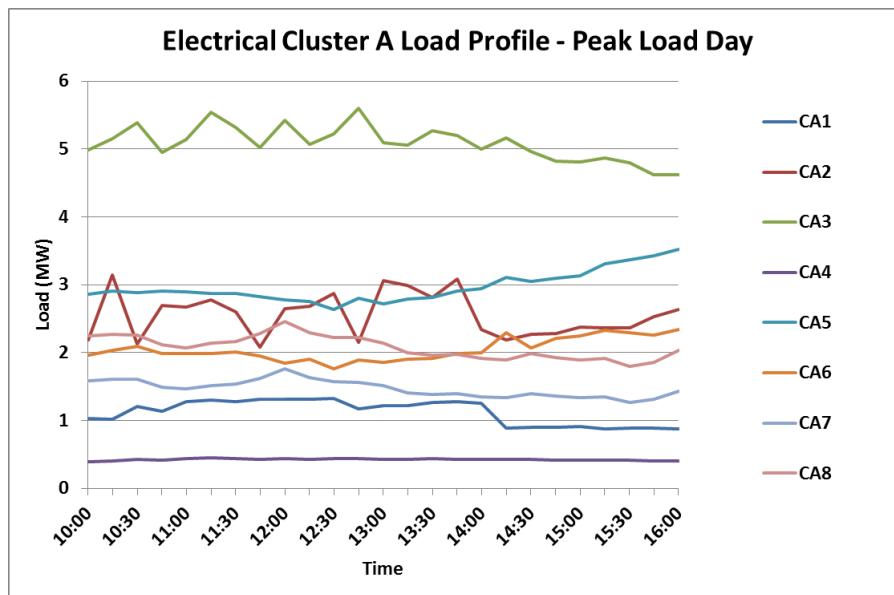

Figure 3.2. Electrical Cluster A Peak Load Profiles.

### 3.1.2 Electrical Cluster A Validation

The validation data for the four transformers in the model – TA1, TA2, TA3 and TA4 – are shown in Figures 3.3 to 3.6 below. For each transformer, the acceptable demand profile is shown on the left, along with the profile that is modeled. These should demonstrate that the demand entered into the SynerGEE model was within 1% of the measured value for both kW and power factor (pf in the chart below). The blue areas on the chart represent the acceptable range for both the kW demand (dark blue) and power factor (light blue). If the solid green line – which represents the kW demand obtained from the model – runs through the dark blue area, this shows that the kW demand has

Hawaiian Electric Company



been modeled within the acceptable range (the measured demand +/-1%). If the orange line remains within the light blue area, this shows that the power factor has also been modeled within the acceptable range (measured power factor +/-1%).

The chart on the right in each case shows the corresponding voltage profile at the transformer. The acceptable range is the measured voltage value in the data provided by the utility  $\pm 0.75V$  (on a 120V base). In cases where alterations are required to the LTC voltage set-point in order to bring the voltage profile within the acceptable range, the original voltage set-point is also shown. The chart on the right also shows the LTC position validation, where data is available.

If the voltage and LTC position can be validated, it shows that the SynerGEE model of the transformer produces results consistent with those observed on the real system. This check provides a degree of confidence in the analysis to report results. If either of these parameters cannot be validated, then there may be too much uncertainty in the results from the SynerGEE model, and the results are considered un-validated. For this report, un-validated parameters will not be reported.

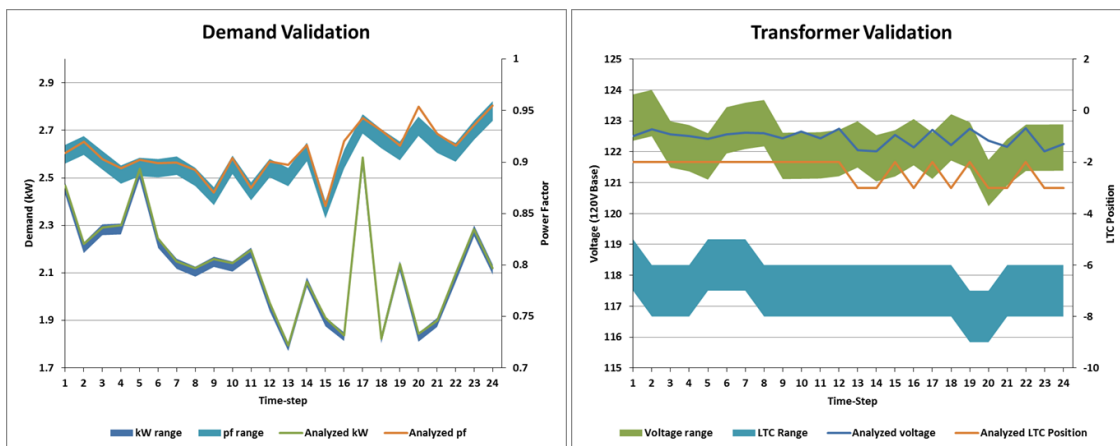

Figure 3.3. TA1 Transformer Validation Results.

The chart on the left in Figure 3.3 shows that the demand was modeled within the acceptable ranges for most of the time-steps. The chart on the right shows that the voltage profile also stays within the acceptable range for all but one of the time-steps. For the time-step where the voltage is out of range, the demand chart shows that the power factor was not modeled within the acceptable range, so the result for this one time-step can be excluded. The voltage behavior is therefore validated for this transformer and the voltage results from the analysis will be reported. As the LTC position could not be modeled within the acceptable range, it is not possible to validate the LTC operation given the existing information and additional investigation is warranted. For purposes of this study, the LTC position results for this transformer are therefore not reported.

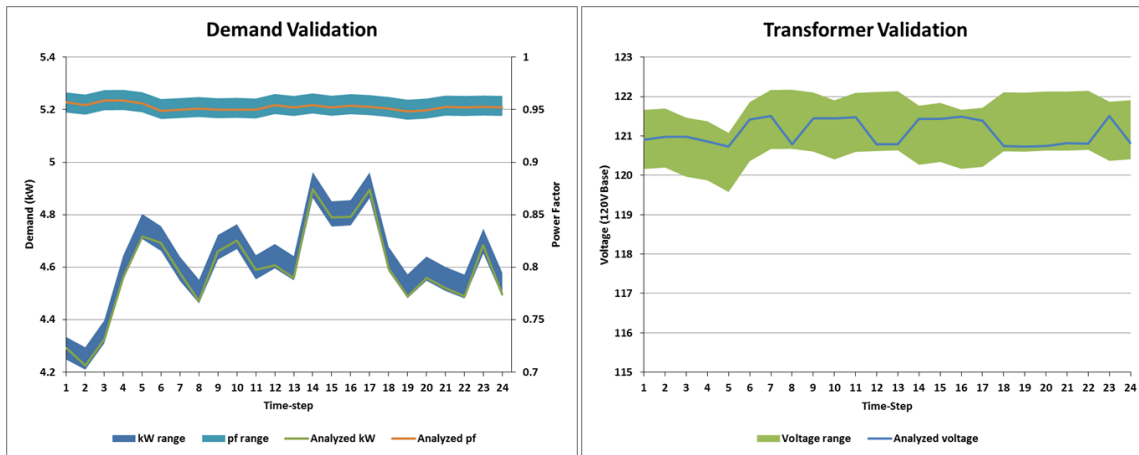

Figure 3.4. TA2 Transformer Validation Results.

The chart on the left in Figure 3.4 shows that the demand is modeled within the acceptable ranges for all of the time-steps. The chart on the right shows that the voltage profile also stays within the acceptable range for every time-step, so the voltage behavior of the transformer can be considered validated and voltage results will be reported for this feeder. As LTC position data is not available for this transformer, the LTC position results are not reported.

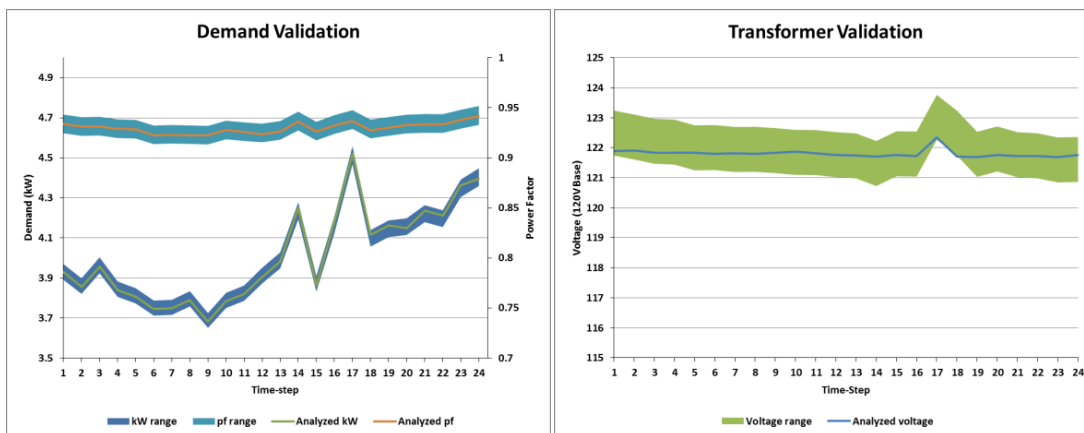

Figure 3.5. TA3 Transformer Validation Results.

The chart on the left in Figure 3.5 shows that the demand is modeled within the acceptable ranges for all time-steps. The chart on the right shows that the voltage profile is also within the acceptable range for all time-steps, so the voltage behavior of this transformer can be considered validated and voltage results can be reported. As LTC position data is not available for this transformer, the LTC position results are not reported.

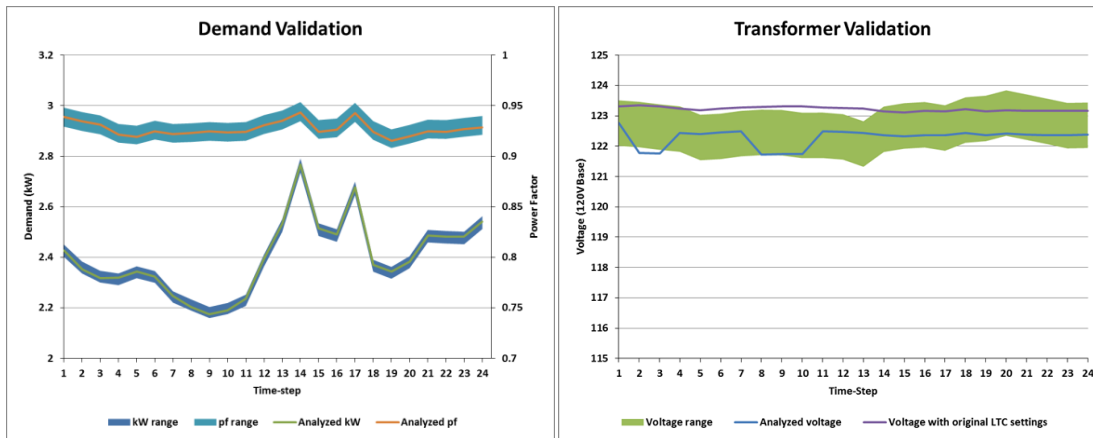

Figure 3.6. TA4 Transformer Validation Results.

The chart on the left in Figure 3.6 shows that the demand is modeled within the acceptable ranges for all time-steps. The chart on the right shows that the voltage profile is not within the acceptable range using the original LTC voltage set-point of 123V. An adjustment of the voltage set-point down to 122V brought the voltage profile within the acceptable range for all but two time-steps, which can be considered acceptable. The voltage behavior of the transformer is therefore considered validated while noting that the LTC voltage set-point had to be adjusted. As LTC position data is not available for this transformer, the LTC position results are not reported.

### 3.1.3 Electrical Cluster A Results

Table 3.3 and Figures 3.7 and 3.8 summarize the results for the distribution circuits on Electrical Cluster A. Table 3.3 tabularizes the circuit conditions and PV penetration levels provided at the time of the study and corresponding backfeed, voltage and loading thresholds assessed.

Table 3.3. Electrical Cluster A Distribution Circuit Results.

Distribution Circuit	SLACA (kW)	Existing PV %	Existing + Queued PV %	5% Fault Current Limit	10% Fault Current Limit	Backfeed Limit	Voltage Limit up to 135%	Loading Limit up to 135%
CA1	1062	29.38%	29.38%	N/A	N/A	68%	None	None
CA2	3531	35.25%	35.25%	N/A	N/A	31%	None	None
CA3	3007	4.25%	12.23%	N/A	N/A	96%	None	None
CA4	520	0.00%	0.00%	N/A	N/A	48%	None	None
CA5	4106	1.25%	5.64%	N/A	N/A	54%	None	None
CA6	2628	32.13%	32.13%	N/A	N/A	66%	None	None
CA7	1688	21.42%	21.42%	N/A	N/A	46%	None	None
CA8	2412	11.98%	20.27%	N/A	N/A	44%	None	None

1. N/A = Not Available (will not be completed within the timeframe of this project)
2. Where limit is given as 'None', this should be understood as 'no limit was found up to PV penetration of 135%'. Limits may exist at higher penetrations than 135%, but these higher penetrations levels are not assessed in this study.

As described in Section 2, threshold limits were evaluated for PV penetrations up to 135%. Limits may exist at higher penetrations and may need to be periodically reassessed as the existing PV and queued levels continue to change.

Figure 3.7 and 3.8 shows the results for all the distribution circuits in Electrical Cluster A. On each graph, the orange dashed lines represent the existing PV penetration, the smaller light-blue dashed lines represent the additional queued PV penetrations, if any. The shaded blue/white ranges represent the limit thresholds based on the PV penetrations range analyzed. The red horizontal line within this range marks the most likely estimate of the limit of PV penetration per criteria investigated (such as backfeed), based on linear approximation between the two PV penetrations defining the range.

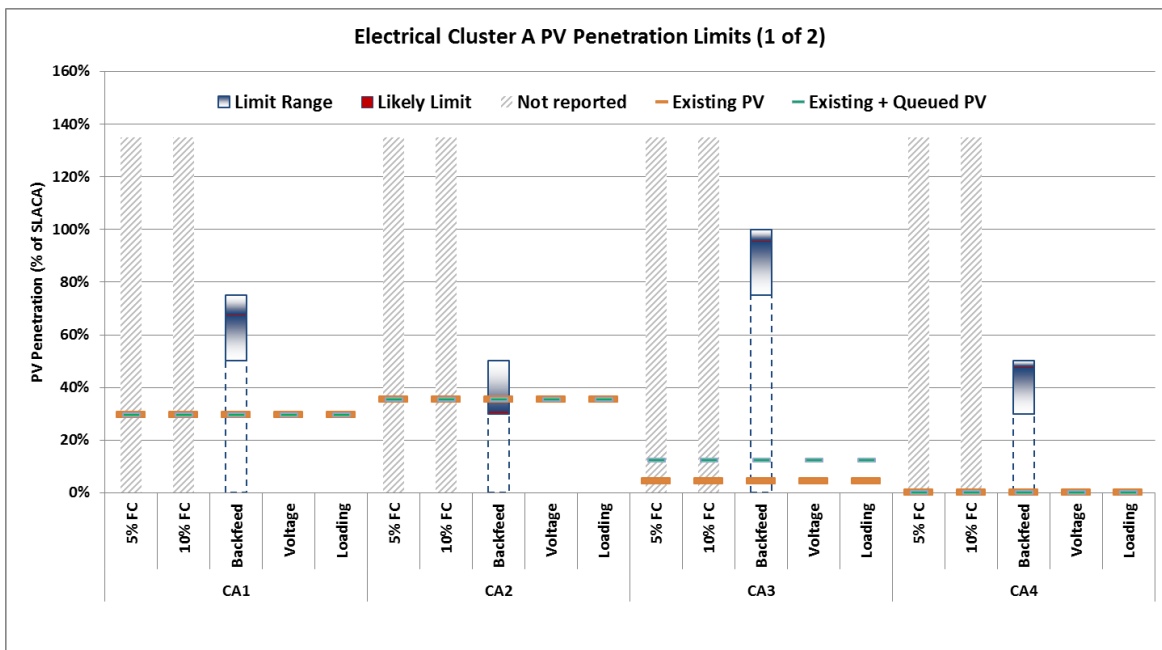

Figure 3.7. Electrical Cluster A Distribution Circuit Results (1 of 2).

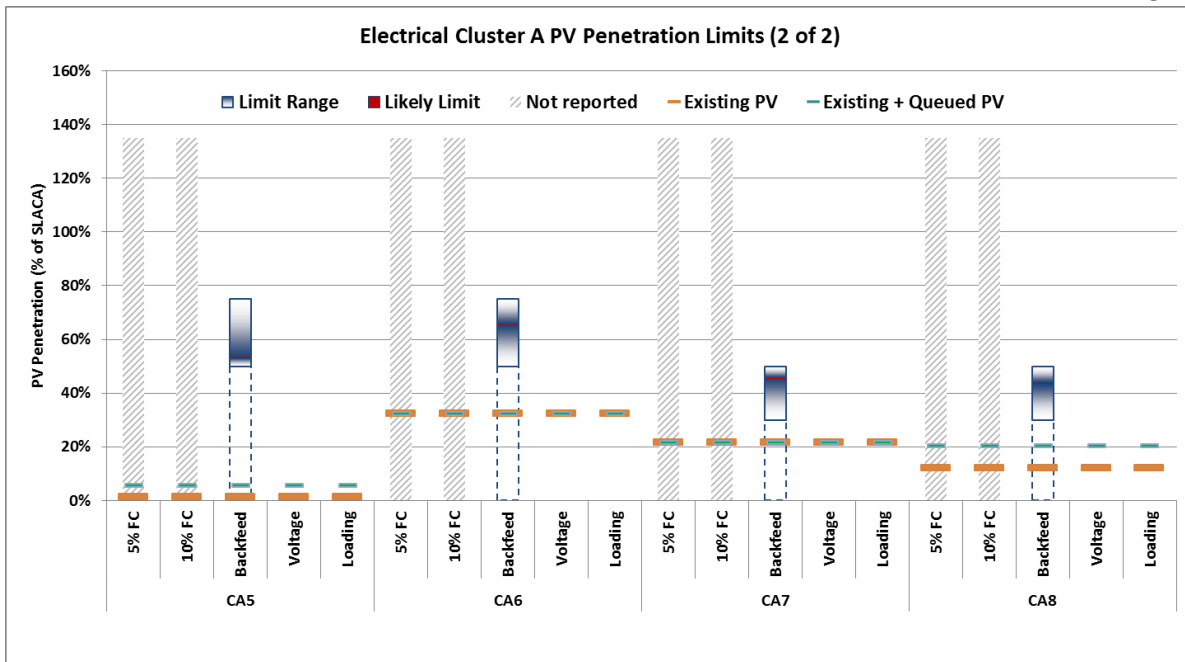

Figure 3.8. Electrical Cluster A Distribution Circuit Results (2 of 2).

Based on Figures 3.7 and 3.8, for all but 1 feeder, there are no existing backfeed conditions on the other circuits given current and queued PV values. However for CA 2, the dashed orange line is within the limit threshold and above the red line, which represents the likely PV penetration at which backfeed occurs. This indicates that there may be situations with the existing PV where reverse power flow at the feeder head (start of the feeder) is possible on this circuit. This condition may result in voltage regulation problems on the feeder. Additionally, from Table 3.1, CA2 is connected to the same transformer (TA1) as circuit CA1. As such, PV penetration conditions on CA1 may also need to be observed for potential backfeed. Under backfeed conditions on CA2 (currently at 35% peak load penetration level), the reverse power flow from PV generation may feed directly into CA1 (currently at 29% peak penetration), assuming CA1 is not near a condition of backfeed. For CA1, its backfeed threshold based on analysis is around 50% and likely limit is near 65%. If the reverse power from CA2 does flow to CA1, measurements taken at the transformer (TA1) would only see a drop in overall load (on both CA1 and CA2) and not the reverse power flow due to PV. If both feeders had reverse power flow – or if the reverse power flow in CA2 is of a higher magnitude than the demand of circuit CA1 – then the transformer would see negative load due to reverse power flow and likely increased voltage problems on the circuits. Based on analysis, further PV penetration increases on circuit CA2 should be monitored along with CA1 conditions to prevent problems caused by reverse power flow and appropriate protection and mitigations measures may need to be considered. Up to the 135% PV penetration study scenario, no loading or voltage violations are observed on these circuits.

Table 3.4 and Figure 3.9 below show the results in tabular and graphical format for the transformers in Electrical Cluster A.

Table 3.4. Electrical Cluster A Transformer Results.

Transformer	Distribution Circuit	SLACA (kW)	Existing PV %	Existing + Queued PV %	Backfeed Limit	LTC Cycling Limit
TA1	CA1, CA2	4593	33.9%	33.9%	39%	N/R
TA2	CA3, CA4	3527	3.6%	10.4%	89%	N/R
TA3	CA5, CA6	6734	13.3%	16.0%	59%	N/R
TA4	CA7, CA8	4100	15.9%	20.7%	45%	N/R

3. N/R = Not Reported (insufficient data available)

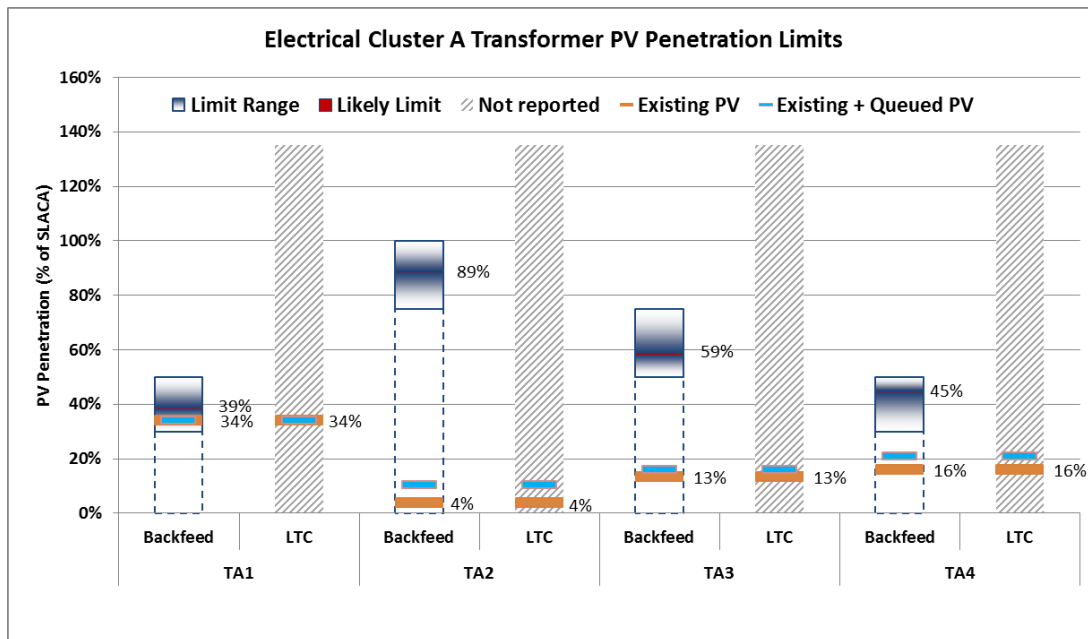

Figure 3.9. Electrical Cluster A Transformer Results.

Figure 3.9 shows that the backfeed threshold on the transformer TA1 has been reached given existing PV penetrations and is only narrowly below the estimated limit (approximately 5%). Reverse power flow may be likely on the transformer, especially on days with very low load (e.g. cool, sunny and breezy days), or if the PV penetration continues to increase on the circuits connected (CA1 and CA2). Additional LTC monitoring and some mitigation may therefore be necessary if more PV is to be accommodated and to prevent issues associated to reverse power flow. For the other transformers the backfeed thresholds are significantly more than the existing or queued PV penetrations, so no mitigations are immediately necessary. While no mitigations may be needed at this time, monitoring of the LTC position data for voltage regulation problems may be something to consider as these circuits have the potential for more PV penetration.

### 3.1.4 Electrical Cluster A Summary

The analysis presented in this report is intended to identify the technical limitations to future deployment of distributed PV generators on distribution circuits attached to the Electrical Cluster A Hawaiian Electric Company

sub-transmission line on Oahu. The distribution circuits' locations, loading and existing PV generation are presented, along with some peak and minimum load profiles. The analysis is split into 34 cases representing different combinations of load profile, installed PV capacity and PV generator output, with the intention that these are used to identify the point at which specific technical limits are exceeded.

Validation processes are performed for the transformers where data was available. In order to get the voltage at the transformers to be consistent with measured data, it is necessary to alter the LTC voltage set-point on one of the transformers (TA4) from the specified set-point. LTC position data is not available for three of the transformers (TA2, TA3, TA4), and LTC behavior is not validated for the fourth (TA1). With the caveat that the LTC voltage set-point is altered for the transformer TA4, the voltage behavior is validated for all transformers in the system.

The results show that one of the distribution circuits (CA2) has existing PV penetrations in excess of the backfeed limit, which suggests that it may already be experiencing reverse power flow at the head of the distribution circuit. The transformer TA1 also has an existing PV penetration very close to the backfeed limit which indicates that there is a strong possibility of reverse power flow occurring at this transformer if any future PV installations are considered. Monitoring and some mitigation measures are therefore necessary on these circuits in order to install further PV systems to address the potential of reverse power flow. Fault Current Rise results are not available at the time due to data limitations and should be addressed in the next analysis cycle.

### 3.2 Electrical Cluster B Evaluation Results

Electrical Cluster B represents a group of feeders serving a mixed base of customers ranging from residential, commercial and industrial in the Halawa Region. The Halawa Region is an ahupua'a, or a narrow wedge-shaped land section that runs North-East to South-West from the mountains to the harbor. The ahupua'a is indicative of the island's natural landscape and is a representative topology of many of the residential load centers on the islands. Thus, the area has good to moderate solar resource due to the valley and mountainous terrain. The analysis covered 7 feeders (CB1 through CB7) serving this community, representing medium length circuits (ranging from 1 mile to 1.5 miles) connected through 4 different transformers (TB1, TB2, TB3, TB4). Table 3.5 presents the distribution circuits included in the analysis, the transformers they are connected through, the SLACA (historical peak load) value and the existing and queued PV generation on the circuit. Table 3.6 below shows which data was available for the distribution circuits included in the study.

Table 3.5. Electrical Cluster B Distribution Circuit Data.

Distribution Circuit	Transformer	SLACA (kW)	Existing PV (kW)	Queued PV (kW)
CB1	TB1	4342	210	500
CB2	TB1	1898	586	0
CB3	TB2	3072	198	0
CB4	TB2	709	722	0
CB5	TB3	2470	0	0
CB6	TB4	3400	426	0
CB7	TB4	3920	926	0

Table 3.6. Electrical Cluster B Data Availability.

Distribution Circuit	SCADA/BMI	Feeder Model	Validation Data
CB1	Yes	Yes	Yes
CB2	Yes	Yes	Yes
CB3	Yes	Yes	Yes
CB4	Yes	Yes	Yes
CB5	No	Yes	No
CB6	Yes	Yes	No
CB7	Yes	Yes	No

Based on the data review, not all feeders have sufficient measured data to perform some of the analysis. In this case as a number of the feeders do not have LTC data for validation, the LTC position results will not be assessed at this time. For feeders with available data, if validation is successful, the following results will be provided.

- CB1 to CB4      All results are reported
- CB6 and CB7      Backfeed, Loading and Fault Current Rise results reported, no LTC or voltage data at this time to present
- CB5              Only Fault Current Rise reported, no load data at this time to present

### 3.2.1 Electrical Cluster B Load Profiles

Figure 3.10 shows the loading profiles in MW on the different feeders on Cluster A for a minimally loaded day (minimum load day). Figure 3.11 below shows feeder loadings on a highly loaded day (peak load day). The profiles are shown over the 10am to 4pm period of analysis for high penetration conditions.

Graphically, these feeders can be reviewed for highest loaded feeder, lowest loaded feeder, peaky load feeders and feeder with limited change between minimum and peak load conditions. For example, CB1 exhibits the highest loading amongst all the feeders during peak and minimum load conditions. CB2, CB3 and CB5 remain relatively steady in terms of loading for both peak and minimum conditions. CB6 and CB7 are connected to TB4 and exhibits peaky load during minimum load conditions. Knowing the range of low and high load swing between minimum load and peak load profiles helps to frame the potential variability impact of PV on the circuit.

From Table 3.5, the penetration of PV on the circuits can be compared. Two examples of observations are provided below that may be useful to inform analysis,

- For CB4, the percent penetration is over already over 100%, and it will be useful to identify what thresholds of exceedance this circuit is already exhibiting.
- For CB4, the percentage penetration (ratio of PV on circuit divided by SLACA) is already over 100% for a small historical peak load of 708kW, whereas for CB5, which has a high historical load of 2470kW, there currently is no PV installed. Better understanding of the types of customers on these circuits through rate classification and future smart meter data



may help to provide insights on user adoption and usage patterns for high penetration circuit analysis.

- CB1 has 210kW of distributed PV with another 500kW in the queue. The resulting percent penetration of PV will be greater than 25% (ratio of PV divided by SLACA). Based on Electric Cluster A analysis, circuits with over 25% penetration showed the potential to backfeed and also required checking of the circuit's associated transformer and any other connected circuit. For CB1, the associated transformer and circuit would be TB1 and CB2, respectively. For CB2, the percent penetration of PV is already greater than 30%. Continued monitoring of CB1 and CB2 may be warranted especially with more PV being planned for CB1.

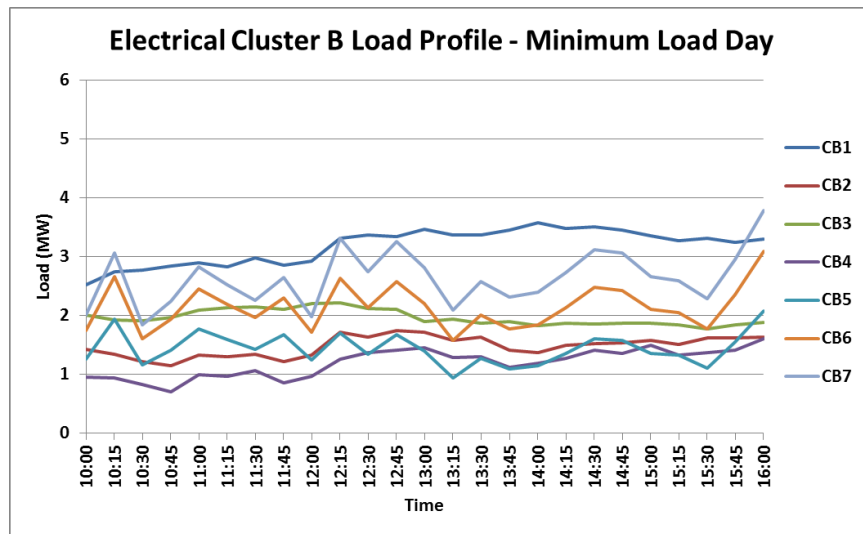

Figure 3.10. Electrical Cluster B Minimum Load Profiles.

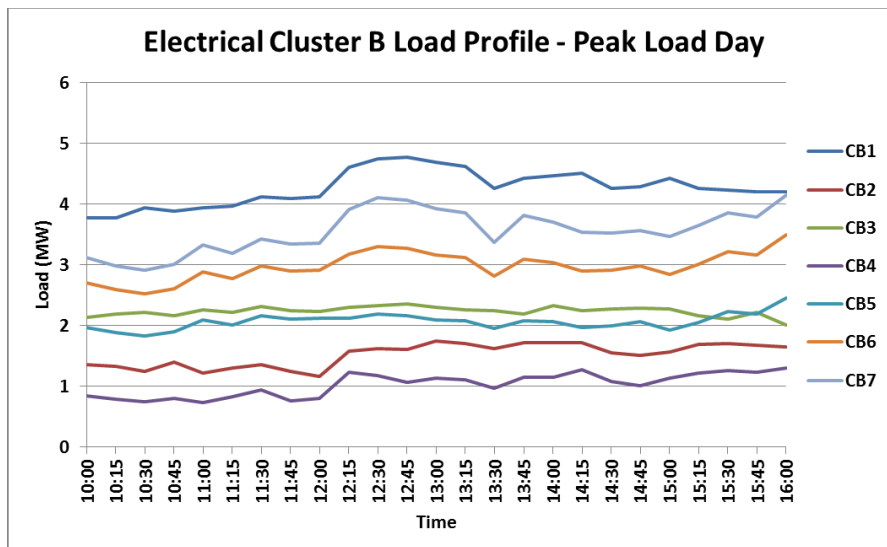

Figure 3.11. Electrical Cluster B Peak Load Profiles.

### 3.2.2 Electrical Cluster B Validation

For validation purposes, only single time instance measurements are available for the transformers TB1 and TB2, so the validation is performed only in these cases, as opposed to the longer load profile shown in Section 3.1.2. This is another advantage of using a consistent approach and reporting format to be able to consistently compare analysis results as the validation data and the input information may vary from circuit to circuit and regions.

The same analysis process is followed as for Electrical Cluster A. For example, a measured value for the transformer (size rating in MVA or power factor rating) is used in the model and set to be within 1% of the measured value. Voltage data obtained from the model is checked for consistency with the measured value. The results are shown in Tables 3.7 and 3.8.

Table 3.7. Transformer TB1 Validation.

Transformer TB1: Instance 1 February 28th 2013 - 14:28	Measured Value	Modeled Value	Validated
<b>TB1 Power (MVA)</b>	5.16	5.14	Yes
<b>TB1 Power Factor</b>	0.959	0.962	Yes
<b>TB1 Voltage</b>	122.5	122.0	Yes
<b>TB1 LTC Position</b>	1(L)	2(L)	Yes

Table 3.8. Transformer TB2 Validation.

Transformer TB2: Instance 1 February 28th 2013 - 14:42	Measured Value	Modeled Value	Validated
<b>TB2 Power (MVA)</b>	2.88	2.89	Yes
<b>TB2 Power Factor</b>	0.991	0.991	Yes
<b>TB2 Voltage</b>	121.67	122.08	Yes
<b>TB2 LTC Position</b>	4(L)	5(L)	Yes

For TB1 and TB2, results summarized in Tables 3.7 and 3.8 show the transform apparent power in units of mega volt-ampere (MVA), power factor, voltage and LTC position. Power factor is a ratio of the power (real power to perform work) to the apparent power (product of the current and voltage of the circuit). Power factor is a number between -1 and 1 and provides an indicator of the current draw. The lower the power factor, the more current the load draws. Higher currents on the circuits result in higher losses, larger wires and higher current equipment on the distribution system. For electrical systems, maintaining unity power factor (PF =1) is desired to minimize costs to customers due to losses and cost of larger equipment. A negative power factor gives an indication that the load may be generating power and back flowing toward the direction of the generator source.

With the demand (measured in terms of MVA and Power Factor) from the model within 1% of the measured values, there is confirmation that the model is capturing the conditions correctly. Validation result also show that the modeled voltage is within the 0.75V of the measured value requirement for voltage and the modeled LTC position is within one step of the measured value. These steps demonstrate and validate the consistency of the SynerGEE model based on the real transformer information both in terms of voltage and LTC position. Therefore, both the voltage results and LTC position results can be validated and will be reported for purposes of the analysis.

### 3.2.3 Electrical Cluster B Results

Table 3.9 and Figure 3.12 and Figure 3.13 summarize the results for the Electrical Cluster B distribution circuits. Table 3.9 tabularizes the circuit conditions and PV penetration levels provided at the time of the study, along with fault current limits and voltage and loading thresholds assessed.

As described in Section 2, threshold limits were evaluated for PV penetrations up to 135%. Limits may exist at higher penetration and may need to be periodically reassessed as the existing PV and queued levels continue to change.

Table 3.9. Electrical Cluster B Distribution Circuit Results.

Distribution Circuit	SLACA (kW)	Existing PV %	Existing + Queued PV %	5% Fault Current Limit	10% Fault Current Limit	Voltage Limit up to 135%	Loading Limit up to 135%
CB1	4342	16.4%	27.9%	26%	59%	None	None
CB2	1898	30.6%	30.6%	27%	61%	None	None
CB3	3072	6.5%	6.5%	44%	104%	None	None
CB4	709	101.3%	101.3%	47%	108%	None	None
CB5	2470	0%	0%	79%	None	N/R	N/R
CB6	3400	12.5%	12.5%	31%	62%	N/R	None
CB7	3920	23.2%	23.2%	30%	62%	N/R	None

- N/R = Not Reported (data not presently available)
- Where limit is given as 'None', this should be understood as 'no limit was found up to PV penetration of 135%' Limits may exist at higher penetrations than 135%, but these higher penetrations are not assessed in this study.

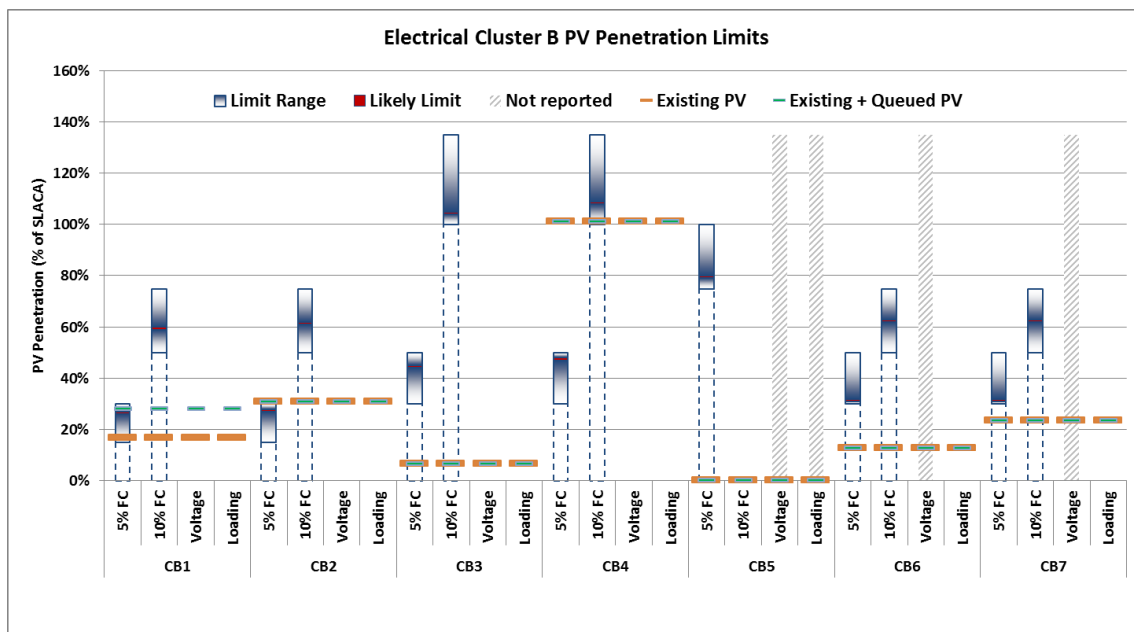

Figure 3.12. Electrical Cluster B Distribution Circuit Results.

Figure 3.12 shows the results for the seven distribution circuits in the cluster. The orange and blue dashed lines represent existing and queued PV levels consistent with Electrical Cluster A descriptions. Points of interest in the results include:

- On CB1 the queued PV penetration (blue dashed line) is above the limit for 5% Fault Current Rise;
- On CB2 the existing PV penetration (orange dashed line) is above the limit for 5% Fault Current Rise;
- On CB4 the existing PV penetration is significantly above the limit for 5% Fault Current Rise, and very close to or in excess of the limits for 10% Fault Current Rise and potential backfeed.

CB4 may already be seeing reverse power flow on some occasions at the head of the circuit, and therefore mitigation measures may be necessary in order to successfully add additional PV. For the feeders where the 5% or 10% rise in Fault Current criteria are exceeded (CB1, CB2 and CB4), additional checks on equipment are necessary to investigate whether the circuit breaker current ratings are exceeded. Inadequate fault current protection may lead to protection coordination issues on the circuit and can lead to equipment damage. The other circuits are not exhibiting these concerns as the PV penetrations are currently well below the thresholds identified in the analysis (denoted with the limit range).

Table 3.10 and Figure 3.13 summarize results for the transformers of Electrical Cluster B. Based on results depicted in Figure 3.13, existing PV penetration levels are well within the backfeed and LTC thresholds on the transformers. At present PV penetration levels, the transformers are not close to or exceeding the backfeed or LTC cycling limit. As penetration levels continue to increase for TB1 up toward 50% and TB2 up toward 30%, as identified by the lower end of the limit range bar, backfeed or LTC conditions need to be reviewed. TB3 and TB4 validation data was not completed and therefore not reported here, however once data is available to validate, similar analysis can be completed and immediately added to these results to track the changes on Cluster B.

Table 3.10. Electrical Cluster B Transformer Results.

Transformer	Feeders	SLACA (kW)	Existing PV %	Existing + Queued PV %	Backfeed Limit	LTC Cycling Limit
<b>TB1</b>	CB1, CB2	6240	20.7%	28.9%	65%	50%
<b>TB2</b>	CB3, CB4	3781	24.2%	24.2%	66%	49%
<b>TB3</b>	CB5, CB6	7320	18.2%	18.2%	47%	N/R

6. N/R = Not Reported (insufficient data available)

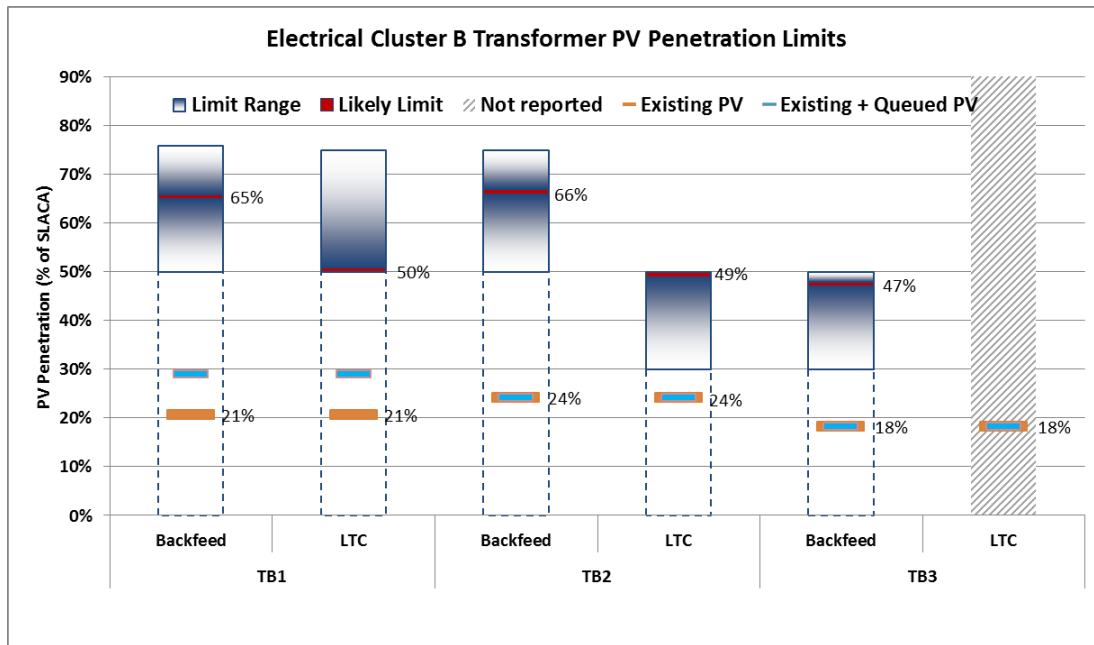

Figure 3.13. Electrical Cluster B Transformer Results.

### 3.2.4 Electrical Cluster B Summary

The analysis presented in this report is intended to identify the technical limitations to future deployment of distributed PV generators on distribution circuits connected to the Electrical Cluster B sub-transmission feeders on Oahu. Validation processes were performed for the transformers where data was available and identified data needs to inform future monitoring. For this evaluation, only single time-steps were used for validation on the TB1 and TB2 transformers. Model results for voltage and LTC position characteristics were successfully validated and reported.

The results show that two of the distribution circuits (CB2 and CB4) have existing PV penetrations in excess of the 5% Fault Current Rise limit. This means that the circuit breaker ratings should be checked to ensure that the total available fault current on these circuits does not exceed the ratings. This is also true for the queued PV penetration on CB1. On CB4, the existing PV penetration is also in excess of the backfeed limit, which indicates that reverse power flow may be occurring at the head of the distribution circuit, and therefore some mitigation measures may be necessary to facilitate increased PV penetration on this circuit without causing problems due to reverse power flow, as described in section 2.2. At the transformer level, none of the existing or queued PV penetrations are close to the identified limiting penetrations, and therefore no mitigation measures are immediately necessary to facilitate increased PV penetrations without causing problems at the transformers.

### 3.3 Electrical Cluster C Evaluation Results

Electrical Cluster C represents a group of feeders serving commercial and residential loads in the West Region. The West Region is less densely populated compared to Electrical Cluster A and B, has more land open space land zoned for agriculture. This area has good solar resource especially at the southern end of the region but has some foothills near residential communities. The analysis covered 5 feeders (CC1 through CC5) serving this community, representing medium to long length

circuits (ranging greater than 1.5 miles) connected through 4 different transformers (TC1, TC2, TC3, TC4). Table 3.11 presents the distribution circuits included in the analysis, the transformers they are connected through, the SLACA (historical peak load) value and the existing and queued PV generation on the circuit. Table 3.12 below shows which data was available for the distribution circuits included in the study.

Table 3.11. Electrical Cluster C Distribution Circuit Data.

Distribution Circuit	Transformer	SLACA (kW)	Existing PV (kW)	Queued PV (kW)
CC1	TC1	6200	173.19	245
CC2	TC2	3850	726.51	300
CC3	TC3	3787	671.383	2950
CC4	TC3	2143	471.07	3050
CC5	TC4	5300	1051.56	1750

Table 3.12. Electrical Cluster C Data Availability.

Distribution Circuit	SCADA/BMI	Feeder Model	Validation Data
CC1	Yes	Yes	Yes*
CC2	Yes	Yes	Yes*
CC3	Yes	Yes	Yes*
CC4	Yes	Yes	Yes*
CC5	Yes	Yes	Yes*

\*: LTC position data not available, only voltage data is available for validation

Based on the data review, not all feeders have sufficient measured data to perform some of the analysis. In this case, the LTC data was not available based on measurements in the field, thus the LTC position results will not be reported at this time. While LTC position is an important indicator for high penetration PV impacts, it is not the sole indicator. As noted in Cluster B analysis, the fault current rise conditions may be a more limiting condition due to circuit protection device capabilities. For Cluster C, a significant amount of the evaluations can still be performed with valuable insights to be gained even without the LTC position data. Through this process, the condition has also been identified for further utility review and prioritized for LTC monitoring equipment so condition can be assessed in future analysis cycles. For feeders with available data, if validation is successful, the following results will be provided.

- All circuits Backfeed, Voltage, Loading and Fault Current Rise results will be reported

Based on Table 3.11, preliminary review indicates that at existing levels, CC5 is approaching 20% penetration, however to accommodate the queued PV, proactive modeling of the circuits to identify threshold and likely exceedance limits on high penetration criteria identified in Table 2.1 is essential. With queued PV, CC3 and CC4, both connected at TC3 will have penetration percentages over 100%. As noted in Cluster A analysis, the condition of backfeed on both circuits and at the transformer (TC3) will require careful review and mitigation. CC5 will also be approaching 50% penetration and based on Cluster B, this was a condition of fault current exceedance on some of the circuits.

### 3.3.1 Electrical Cluster C Load Profiles

Figure 3.14 shows the loading profiles in MW on the different feeders on Cluster C for a minimally loaded day (minimum load day). Figure 3.15 shows feeder loadings on a highly loaded day (peak load day). The profiles are shown over the 10am to 4pm period of analysis for high penetration conditions.

Graphically, these feeders can be reviewed for highest loaded feeder, lowest loaded feeder, peaky load feeders and feeder with limited change between minimum and peak load conditions. For example, CC1 exhibits the highest loading (at or above 4 MW) amongst all the feeders during peak and minimum load conditions. CC1 and CC4 remain relatively steady in terms of loading for both peak and minimum conditions.

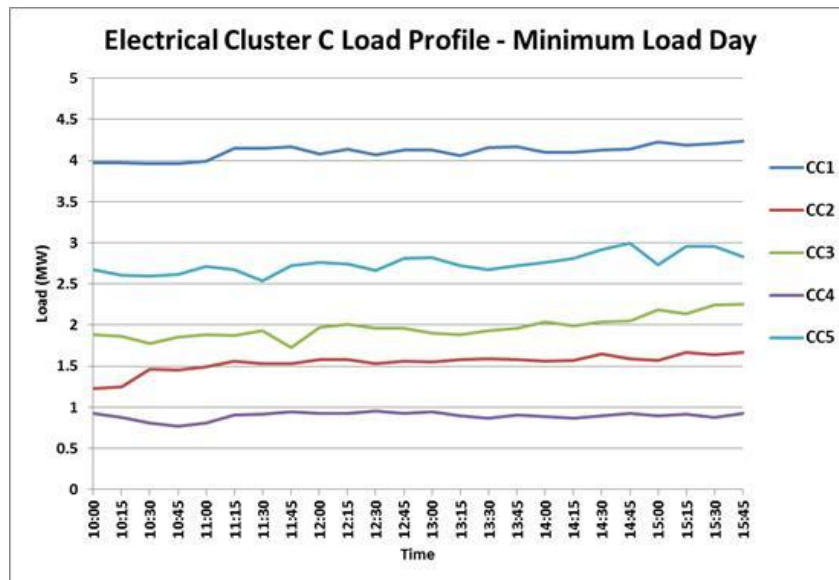

Figure 3.14. Electrical Cluster C Minimum Load Profiles.

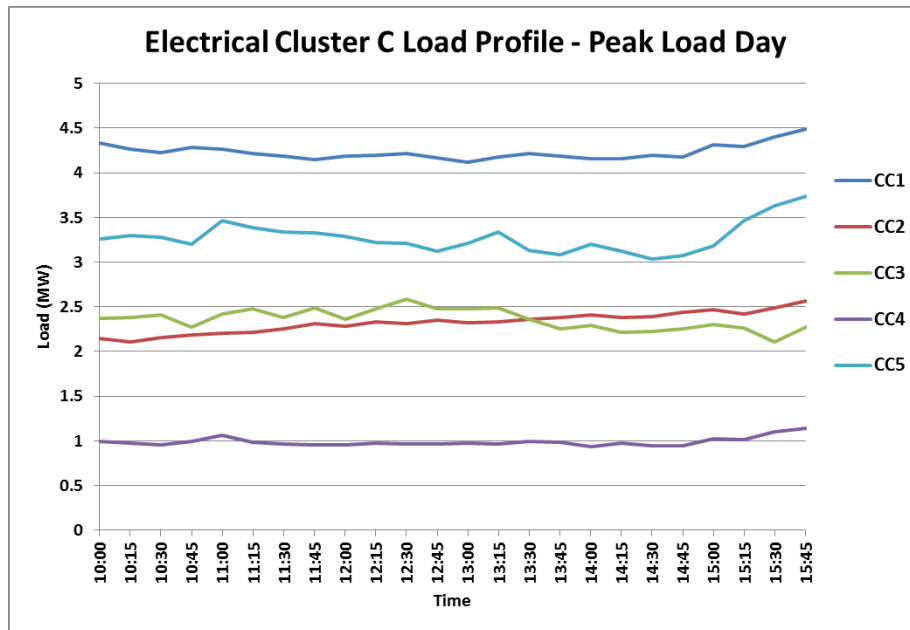

Figure 3.15. Electrical Cluster C Peak Load Profiles.

### 3.3.2 Electrical Cluster C Validation

The validation data for four of the transformers in the model – TC1, TC2, TC3 and TC4– are shown in Tables 3.13 to 3.20. Two different measured daytime instances are used for validation (April 8<sup>th</sup> and April 23<sup>rd</sup>). The values measured and obtained from the model are shown. In some instances, the LTC set points had to be adjusted for the conditions to be validated, similar to Cluster A.

Table 3.13. Transformer TC1 Instance 1 Validation.

Transformer TC1: Instance 1 April 8 <sup>th</sup> 2012 – 12:03	Measured Value	Modeled Value (Original Settings)	Modeled Value (LTC setpoint adjusted)	Validated
<b>TC1 1 MVA</b>	4.85	4.85	4.87	Yes
<b>TC1 Power Factor</b>	0.9	0.9	0.9	Yes
<b>TC1 Voltage</b>	122.18	124.39	122.79	Yes
<b>TC1 LTC Position</b>	N/A	N/A	N/A	No

Table 3.14 Transformer TC1 Instance 2 Validation

Transformer TC1: Instance 2 April 23 <sup>rd</sup> 2012 – 12:34	Measured Value	Modeled Value (Original Settings)	Modeled Value (LTC setpoint adjusted)	Validated
<b>TC1 MVA</b>	4.600	4.618	4.597	Yes
<b>TC1 Power Factor</b>	0.9	0.9	0.9	Yes
<b>TC1 Voltage</b>	121.51	124.62	122.25	Yes
<b>TC1 LTC Position</b>	N/A	N/A	N/A	No



Table 3.15. Transformer TC2 Instance 1 Validation.

Transformer TC2: Instance 1 March 16 <sup>th</sup> 2012 - 12:01	Measured Value	Modeled Value (Original Settings)	Modeled Value (LTC setpoint adjusted)	Validated
<b>TC2 MVA</b>	3.24	3.238	3.242	Yes
<b>TC2 Power Factor</b>	0.9	0.9	0.9	Yes
<b>TC2 Voltage</b>	122.14	124.87	121.74	Yes
<b>TC2 LTC Position</b>	N/A	N/A	N/A	No

Table 3.16. Transformer TC2 Instance 2 Validation.

Transformer TC2: Instance 2 March 28 <sup>th</sup> 2012 - 14:18	Measured Value	Modeled Value (Original Settings)	Modeled Value (LTC setpoint adjusted)	Validated
<b>TC2 MVA</b>	3.042	3.042	3.044	Yes
<b>TC2 Power Factor</b>	0.9	0.9	0.9	Yes
<b>TC2 Voltage</b>	122.06	125.04	121.91	Yes
<b>TC2 LTC Position</b>	N/A	N/A	N/A	No

Table 3.17. Transformer TC3 Instance 1 Validation.

Transformer TC3: Instance 1 March 16 <sup>th</sup> 2012 - 12:01	Measured Value	Modeled Value (Original Settings)	Modeled Value (LTC setpoint adjusted)	Validated
<b>TC3 MVA</b>	3.477	3.466	3.478	Yes
<b>TC3 Power Factor</b>	0.9	0.9	0.9	Yes
<b>TC3 Voltage</b>	122.281	123.79	122.19	Yes
<b>TC3 LTC Position</b>	N/A	N/A	N/A	No

Table 3.18. Transformer TC3 Instance 2 Validation.

Transformer TC3: Instance 2 March 28 <sup>th</sup> 2012 - 14:18	Measured Value	Modeled Value (Original Settings)	Modeled Value (LTC setpoint adjusted)	Validated
<b>TC3 MVA</b>	3.434	3.436	3.435	Yes
<b>TC3 Power Factor</b>	0.9	0.9	0.9	Yes
<b>TC3 Voltage</b>	121.972	123.81	122.22	Yes
<b>TC3 LTC Position</b>	N/A	N/A	N/A	No

Table 3.19. Transformer TC4 Instance 1 Validation.

Transformer TC4: Instance 1 March 16 <sup>th</sup> 2012 - 12:01	Measured Value	Modeled Value (Original Settings)	Modeled Value (LTC setpoint adjusted)	Validated
--	----------------	-----------------------------------	---------------------------------------	-----------

<b>TC4 MVA</b>	2.633	2.631	2.632	Yes
<b>TC4 Power Factor</b>	0.9	0.9	0.9	Yes
<b>TC4 Voltage</b>	121.35	123.18	120.83	Yes
<b>TC4 LTC Position</b>	N/A	N/A	N/A	No

Table 3.20. Transformer TC4 Instance 2 Validation.

<b>Transformer TC4: Instance 2 March 28<sup>th</sup> 2012 – 14:18</b>	<b>Measured Value</b>	<b>Modeled Value (Original Settings)</b>	<b>Modeled Value (LTC setpoint adjusted)</b>	<b>Validated</b>
<b>TC4 MVA</b>	2.661	2.662	2.657	Yes
<b>TC4 Power Factor</b>	0.9	0.9	0.9	Yes
<b>TC4 Voltage</b>	121.004	123.24	120.9	Yes
<b>TC4 LTC Position</b>	N/A	N/A	N/A	No

In all instances, summaries show that the voltage is not within the required band-width of 0.75V using the original LTC voltage set-point of 122V. In order to shift the voltage down towards the measured value, the LTC set-point is changed to 120V, and with this setting the tables show that the voltage is within 0.75V of the measured value at both time-steps. Therefore, with the caveat that the LTC voltage set-point has been changed from the given value, these transformers can be considered validated for voltage. Data on LTC position was not available at this time, so these results are not reported for these transformers.

### 3.3.3 Electrical Cluster C Results

Table 3.21 and Figure 3.16 show the results for the five distribution circuits in Electrical Cluster C. There are several areas of interest to point out. Based on existing PV installations, none of the circuits are in excess of the identified thresholds and exceedance limits. However, at queued PV penetrations, circuits CC3, CC4 and CC5 are in excess of Fault Current Rise and Backfeed limits, indicating that several problems are likely to occur if all of the queued PV is installed. Note how much CC4 is in exceedance of the likely backfeed and fault current limits as the queued level is even beyond the upper 135% of the analysis threshold. Based on these new thresholds and exceedance limits, the queued projects may need to be reassessed. Issues of concern include:

- If the Backfeed limit is exceeded, reverse power flow may occur at the feeder head may cause problems for voltage regulation on the feeder and some mitigation measures may be necessary.
- Where the Fault Current Rise limits are exceeded, the available fault current should be checked to ensure that it does not exceed the current rating on the circuit breakers.

As there seems to be interest in more PV installations based on the larger queued projects and availability of land in this region, additional monitoring and timely reassessment of SLACA numbers and circuit LTC performance is recommended.

Table 3.21 Electrical Cluster C Distribution Circuit Results

Distribution Circuit	SLACA (kW)	Existing PV %	Existing + Queued PV %	5% Fault Current Limit	10% Fault Current Limit	Voltage Limit up to 135%	Loading Limit up to 135%
CC1	6200	10.8%	14.8%	N/A	N/A	122%	None
CC2	3850	9.3%	17.1%	47%	99%	None	None
CC3	3787	13.0%	90.9%	38%	89%	None	None
CC4	2143	22.0%	188.0%	42%	96%	None	None
CC5	5300	19.8%	52.9%	33%	74%	None	127%

7. N/A = Not Available (analysis will not be completed within the timeframe of this project)
8. Where limit is given as 'None', this should be understood as 'no limit was found up to PV penetration of 135%' Limits may exist at higher penetrations than 135%, but these higher penetrations are not assessed in this study

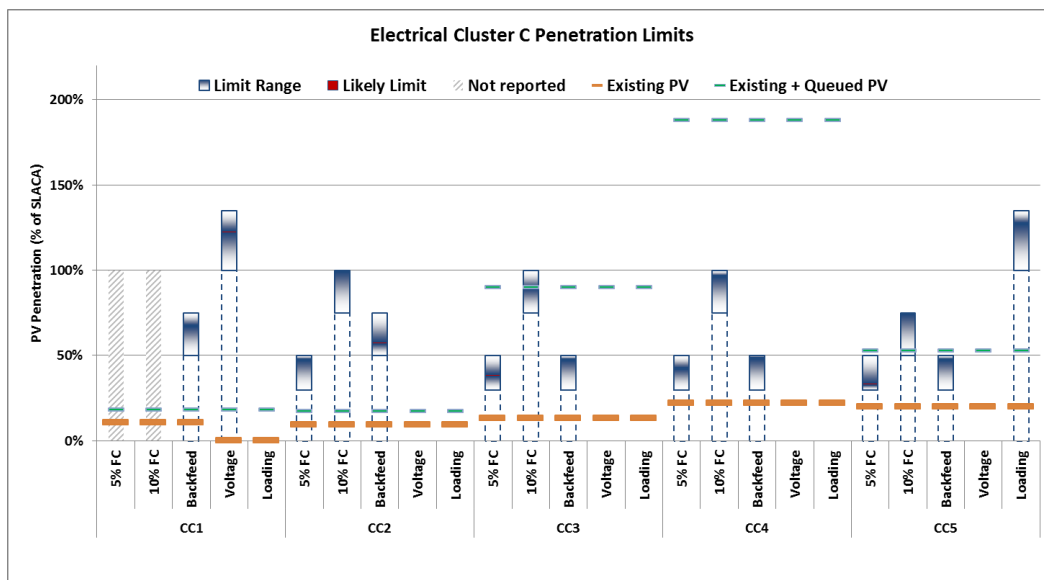

Figure 3.16. Electrical Cluster C Distribution Circuit Results.

Table 3.22 and Figure 3.17 summarize the results for the transformers in Cluster C. Existing and queued penetrations on the transformers are within the thresholds identified for transformers TC1 and TC2. For transformers TC3 and TC4 the existing PV penetrations are also within the threshold limits, but if all the queued PV on the circuits are included, reverse power flow at the transformer is likely given current circuit configurations and will cause problems for voltage regulation equipment. Managing levels within the Backfeed and LTC threshold limits would be an initial recommendation to minimize unforeseen impacts on the system and would allow for further monitoring as penetration levels increase. For TC3, for example the backfeed threshold is more limiting than the LTC threshold. Initial Backfeed lower threshold range is around 30% penetration with likely exceedance limit at 47% (red line) where the LTC exceedance limit is at 76%. Queued levels on TC3 would push the penetration to 125% which is nearly 50% over the exceedance limit. These values provide insight on what may be practical given upgrade costs versus impact on system reliability and can be used to periodically track penetration.

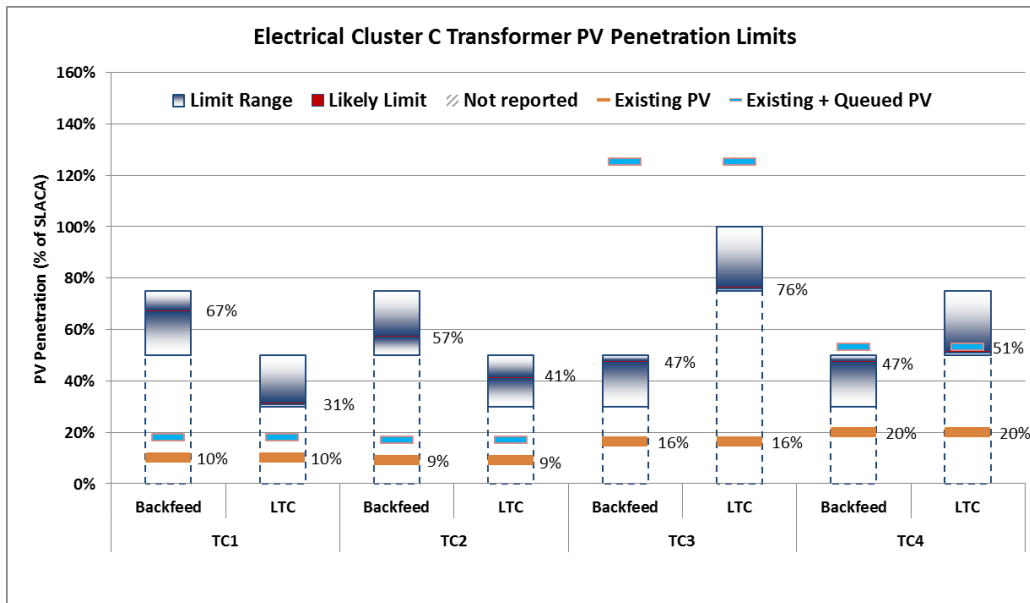

Figure 3.17. Electrical Cluster C Transformer Results.

Table 3.22. Electrical Cluster Transformer Results.

Transformer	Distribution Circuit	SLACA (kW)	Existing PV %	Existing + Queued PV %	Backfeed Limit	LTC Cycling Limit
TC1	CC1	6200	10.8%	14.8%	67%	31%
TC2	CC2	3850	9.3%	17.1%	57%	41%
TC3	CC3, CC4	5930	16.3%	125%	47%	76%
TC4	CC5	5300	19.8%	52.9%	47%	51%

9. N/R = Not Reported (Requires additional information, not within timeframe of this project)

### 3.3.4 Electrical Cluster C Summary

For Cluster C, validation was performed based on 2 time instances. Validation indicated that additional monitoring for LTC position information is needed as it was necessary to alter the LTC voltage set-point on all the transformers in order to achieve validation of voltage conditions. LTC position data is unavailable for any of the transformers in this study, so this aspect has not been validated, and any limitations on increased PV penetration due to LTC cycling are not identified in this analysis. Additionally, more frequent analysis may also be needed given the great interest in PV development in the region, as indicated by the queue.

The analysis provided threshold ranges and exceedance limits based on the Technical Criteria established for high penetration PV evaluation. At present levels of PV, results showed that all circuits are within threshold and exceedance levels. The queued PV penetrations on the system are very high, and if all of the queued PV on distribution circuits (CC3, CC4 and CC5) is implemented, Fault Current Rise and Backfeed limits will be exceeded. If Fault Current Rise limits are exceeded, further analysis is necessary to check that the circuit breaker current rating is not exceeded by the available fault current. If this rating is exceeded, the circuit breaker would have to be upgraded to facilitate increased PV penetration. If the Backfeed limit is exceeded, mitigation measures may be

required to ensure that reverse power flow does not cause problems for voltage regulation equipment, which can result in unstable voltages on the distribution circuit. Transformers TC3 and TC4 would also be likely to see reverse power flow if all of this queued PV is installed.

Mitigation measures including upgrades to facilitate all these PV systems will warrant a further level of evaluation to assess the economic and reliability impact for the need to increase PV to these levels at these locations. This level of review is beyond the Proactive analysis however the hope is that these thresholds on circuits, once determined and assessed in a timely fashion can be used to inform decisions.

### 3.4 Applying Results to Quantify Remaining Capacity on Feeders

Results of detailed feeder and cluster analysis in the previous sections are summarized in Table 3.23. Instead of percentage limits, the % Backfeed Limit and % LTC Cycling Limit values are converted back into kW of remaining capacity to provide perspective on the potential of more PV installations. This remaining capacity however is only a projection and may be further constrained depending on system conditions (due to changing on-line generation) and dynamic analysis such as contingency considerations in Section 4. These steady-state runs provide perspective on the thresholds at the distribution level which can now be consistently aggregated up to the system level so distribution level impacts may be included in system level assessments.

As shown in Table 3.23, the simulation based limits for each of the Electrical Clusters is presented in kW. Results at the Transformer level provide perspective on the distribution impacts due to high penetration PV. For example, for Cluster B – TB1 in Table 3.23, the Backfeed Limit is 4056 kW and the LTC Cycling Limit is 3120 kW. These kW values correspond to the % values presented in Figure 3.13 and Table 3.10 (65% Backfeed Limit equates to 4056 kW and 50% LTC Cycling Limit equates to 3120 kW). The remaining capacity for Backfeed and LTC are calculated by taking the difference of these limits and the Existing PV in kW. For Cluster B – TB1, the Remaining Capacity by Backfeed is 2764 kW which is the difference between 4056 kW (Backfeed Limit) and 1292 kW (Existing PV). For Cluster B – TB1, the Remaining Capacity by LTC is 1828 kW which is the difference between 3120 kW (LTC Cycling Limit) and 1292 kW (Existing PV).

The lower of the Backfeed or LTC is chosen as the Remaining Transformer Level Capacity and is shown in 'red' in Table 3.23. This value can then be used to assess new installations that are in the Existing + Queued (shown in 'BLUE' in Table 3.23) column. Per the evaluation, for Cluster B and Cluster C, a number of the Transformers within each cluster will exceed remaining capacity levels if all queued PV is installed.

Table 3.23. Summary of Cluster A, B and C Results by Transformer Limits.

Electrical Cluster and Transformer	Existing PV (kW)	Existing + Queued PV (kW)*	Backfeed Limit (kW)	Remaining Capacity by Backfeed (kW)	LTC Cycling Limit (kW)	Remaining Capacity by LTC (kW)	Remaining Transformer Level Capacity (kW)**
Cluster A - TA1	1557	1557	1791	234	N/R	N/R	234
Cluster A - TA2	127	367	3139	3012	N/R	N/R	3012

<b>Cluster A - TA3</b>	896	1077	3973	3077	N/R	N/R	3077
<b>Cluster A - TA4</b>	652	849	1845	1193	N/R	N/R	1193
<b>Cluster B - TB1</b>	1292	1803	4056	2764	3120	1828	1828
<b>Cluster B - TB2</b>	915	915	2495	1580	1853	938	938
<b>Cluster B - TB3</b>	1332	1332	3440	2108	N/R	N/R	2108
<b>Cluster C - TC1</b>	670	918	4154	3484	1922	1252	1252
<b>Cluster C - TC2</b>	358	658	2195	1836	1579	1220	1220
<b>Cluster C - TC3</b>	967	7413	2787	1821	4507	3540	1821
<b>Cluster C - TC4</b>	1049	2804	2491	1442	2703	1654	1442

\* PV penetration levels at the time of analysis

\*\* Remaining capacity value listed may be further constrained by system conditions and are presented to offer perspective versus an absolute number.

Table 3.24 shows each of the Clusters’ total Existing PV, Queued PV and Total Remaining Capacity. Results at the Cluster level provide perspective on likely potential for system impacts due to high penetration PV. The Total Remaining Capacity for the Cluster is calculated by adding the individual Remaining Transformer Level Capacities shown in Table 3.23. Only the Transformer Remaining Capacity is additively shown and compared with Existing + Queued PV. This offers a quick way to gauge penetration levels at the Cluster level and potential to impact the system. Assessments however still need to be conducted based on the individual Transformer level thresholds and individual Transformers penetrations due to PV.

Table 3.24. Existing PV, Queued PV and Remaining Transformer Level Capacity for Cluster A, B & C.

	Existing PV (kW)	Existing + Queued PV (kW)*	Total Remaining Capacity for Cluster (kW)**	Grid Impact Factor (GIF)
<b>Cluster A Total</b>	3232	3850	7517	0.49
<b>Cluster B Total</b>	3539	4051	4874	0.16
<b>Cluster C Total</b>	3044	11793	5735	-1.05

The Grid Impact Factor (GIF) provides a gauge of impact to the grid. Positive GIF has more available capacity for DG installations. Large negative GIF indicates constrained and likely extensive studies and mitigations. GIF close to 0 indicates the Cluster should be closely monitored as it is approaching a threshold of exceedance identified in the study.

- For Cluster A, all transformer levels are within the remaining threshold values based only on the Backfeed Limit threshold as LTC data was not available for this cluster. Cluster A – TA1 is getting close to its transformer’s Remaining Capacity of 234 kW. While the Existing + Queued

PV values for the other transformers (TA2 through TA4) are a little more than half of the remaining capacity, LTC monitoring is advised to be implemented so the backfeed threshold can also be assessed in a timely basis. Based on other cluster evaluations, the LTC threshold can be more limiting than backfeed conditions due to the physical characteristics of the feeder (e.g. length, conductor size, type of loads). From a system impact perspective, at the current levels assessed, this cluster has relatively low impact with a GIF = 0.49. However as noted above, LTC monitoring is recommended to assess limits based on these thresholds.

- For Cluster B, the results on all transformers (TB1 to TB 3) indicate that there is remaining capacity to consider all the Existing + Queued PV assessed within the timing of this analysis using June 2013 data. Some mitigation measures related to backfeed may need to be considered and evaluated by the utility as demand to install PV (shown as 4051 kW) is approaching the 4874 kW threshold given the increase in the queue. From a system impact perspective, at the current levels assessed, this cluster has moderate impact with a GIF = 0.16 which means more routine monitoring at the feeders.
- For Cluster C, results show that the demand for PV in the queue will surpass the existing infrastructure with a GIF = -1.05. Specifically at Cluster C – TA3, the Existing + Queued PV is 7413 kW and the Remaining Transformer Level Capacity is 1821 kW from Table 3.23. At the distribution level, as the feeders are interconnected by their transforms and transformer loads may also be switched over to other feeders for maintenance or switching conditions, protection devices that sense backfeed and review of circuit switching schemes need to be closely reviewed by Distribution Planning. Given the current queue at the time of the study (June 2013 data), demand for PV has increased on all Transformers from an aggregated installed total of 3044 kW to 11,793 kW or 8749 kW of new PV requested to be installed. Total Remaining Capacity for Cluster is estimated at 5735 kW from Table 3.24. If approximately 5000 kW of the 5735 kW is installed (pending other switching and system considerations which may reduce this value), there are still over 3700 kW (11,793 – 3044 kW (existing) – 5000 kW (assumed queued and installed)) more to consider in the queue that is beyond the existing infrastructure capabilities. Assuming 3 kW typical sized installations for a home on Oahu, this equates to approximately 1666 customers added with PV and 1200 customer in excess of the limit. Assuming 500 kW Feed-in-Tariff installations, this would equate to approximately 10 projects interconnected and 6 projects in exceedence. Customers and developers need to work with the utility to understand interconnection needs, the cost implications and determine the cost effectiveness of further additions to the feeders and any mitigation pursued.

Such analysis provides perspective on the challenges utility planners face. The evaluation methodology also provides a transparent process to further investigate appropriate upgrades and mitigation strategies with customers and developers. For some transformers and existing infrastructure, the costs may surpass the need and the sooner those instances can be identified, the more informed the customer and developers may be in further waiting or pursuing costly upgrades or studies. Actively addressing the queue of projects also ensures the most viable projects remain to be considered for interconnection.

## 4.0 RESULTS – DYNAMIC ANALYSIS OF GENERATOR TRIP EVENT

To assess the impact of distributed PV on system and on time variant conditions, dynamic analysis must be performed using an appropriate model. This portion of the Proactive Approach uses the PSS/E model to conduct dynamic analysis. The model is built in the licensed PSS/E software developed by Siemens. The proprietary transmission system data set for Oahu originates from Hawaiian Electric’s Transmission Planning group, and forms the basis of the analysis.

The dynamic portion of the Electric Cluster study is aimed at identifying any technical violations due to transient events at sub-transmission and transmission circuit levels – in this case the transient event is the scenario where the largest generator on the transmission system trips offline. The dynamic studies criteria for PV penetration limits are:

- Extra load shedding (compared to case with no PV) due to under-frequency inverter trips; and,
- Extra load shedding (compared to case with no PV) due to over-voltage inverter trips.

Similar to the steady-state analysis, the dynamic analysis follows a data review and model validation process. Once validated, the simulation is conducted based on a prescribed scenario which in this case is a N-1 or contingency event due to the loss of a large generator on the transmission system. Other contingencies will need to be assessed but to show the connection of the steady state and dynamic models for the Proactive Approach, this scenario example is described for the circuits evaluated.

### 4.1 Analysis Process

To capture the distributed PV impacts, the existing Oahu transmission model had to be extended with distribution infrastructure information based on the Electric Cluster models in SynerGEE. Figure 4.1 illustrates the additional modeling architecture that was added for the purposes of this. It should be noted that the existing transmission model includes further systems above the 138kV branch shown in blue in Figure 4.1 (such as other 138kV sub-stations and generation connected to the transmission system), and the section shown in green was added as part of the model enhancements to incorporate the impact of the distribution system and distributed DG, as part of the distribution network and to capture the PV as distributed generators.

The transmission data set originally provided runs from the 138kV level down to the 46kV side of the 138/46kV transformers in the system, but does not include anything beyond this level (i.e. it does not include the actual 46kV sub-transmission lines or the 12kV distribution circuits). Therefore, for each Electrical Cluster study performed, the 46kV sub-transmission line is added to the relevant transformer, along with a 46/12kV transformer to represent each sub-station on the 46kV feeder. On the 12kV side of each of the 46/12kV transformers the existing generators are aggregated to a single generator, the future generators (used for the increased PV penetrations) are aggregated to a separate single generator, and the load is aggregated to a single load. This is illustrated in Figure 2.12.

The rationale for aggregating the generators in this way is that

- 1) it is understood that the existing PV generator inverters will disconnect at a different frequency level to the future PV generator inverters, and that all inverters with the same settings will behave the same way; and



- 2) it reduces the complexity and processing time, but it should be noted that the voltage drop (or rise at higher PV penetrations) along the 12kV feeder is not considered in this analysis. As discussed in Section 2.4.3, voltage drops along a circuit in the direction of current flow due to the resistance of the conductors. In the worst cases, the maximum voltage drop from the 12kV feeder head in the steady-state analyses is 1.1%, while the maximum voltage rise from the 12kV feeder head is 0.475%. The voltage rise value is considered more significant in this analysis as over-voltage tripping is more likely than under-voltage.

If the dynamic analysis produces a result where the voltage is very close to the disconnect setting of the inverters, it should be checked whether it is within these ranges of the disconnect setting. The settings assumed for the inverters are given in Table 4.1. Clearing times represent the time for which the disconnect criterion must be maintained in order for the inverter to disconnect from the circuit.

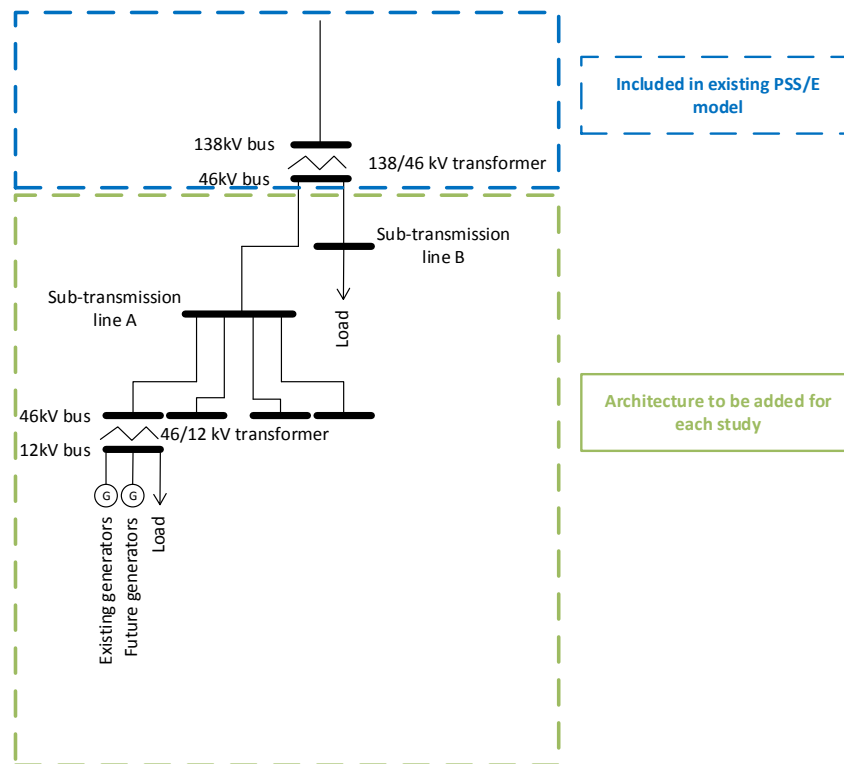

Figure 4.1. Dynamic Model Architecture includes Distribution Level representation in the Transmission Model.

Table 4.1. Inverter Trip Settings.

Setting	Disconnect Criterion	Generators Clearing Time
<b>Under voltage</b>	$V < 50\%$ of base voltage	10 cycles (0.16 seconds)
<b>Under voltage</b>	$50\% < V < 88\%$ of	120 cycles (2 seconds)

	base voltage	
<b>Over voltage</b>	110% < V < 120% of base voltage	60 cycles (1 second)
<b>Over voltage</b>	V > 120% of base voltage	10 cycles (0.16 seconds)
<b>Under frequency - Future Generators</b>	Frequency < 57 Hz	10 cycles (0.16 seconds)
<b>Under frequency - Existing Generators</b>	Frequency < 59.3 Hz	10 cycles (0.16 seconds)
<b>Over frequency</b>	Frequency > 60.5 Hz	10 cycles (0.16 seconds)

## 4.2 Input Data

The transmission model in PSS/E includes a data warehouse of information on equipment to include in that model. However, as PSS/E is typically a transmission model, the 12 kV distribution equipment data does not exist. For distributed generation and distribution architecture representation, the equipment data is imported into PSS/E from the SynerGEE model so that the model parameters remain consistent between the steady-state studies and dynamic analysis.

The dynamic model also includes load data at the 46kV level of the 138/46kV transformer (see Figure 4.1), while for the study this must be broken down by each 12kV distribution circuit. Each of the 138/46kV transformers feeds either one or two 46kV sub-transmission lines. The load given in the model is therefore split between the two sub-transmission lines for the purposes of the study, and the split is calculated in proportion to the peak load value of the connected feeders. As the cluster study generally concerns only one 46kV line, the load on the other line connected to the 138/46kV transformer can be aggregated at a separate 46kV bus. The load on the sub-transmission line under study is further broken down by the 46/12kV transformers, again in proportion to their peak load.

A snapshot of the system or point of reference was desired at the onset of this study. To meet the timeframe of the project, the existing distributed generation (DG) capacities used for this analysis are thus from a June 2013 level provided by the utility planning coinciding with the latest version of the model for the distribution infrastructure at the time of project initiation. This maintains consistency between the latest model extraction of the infrastructure and the baseline load and DG capacities. For both the steady state and dynamic analysis, maintaining baseline consistency is more important than capturing the latest values. The reason is that studies will be conducted to capture a range of penetrations beyond existing values and the installed technologies, such as the inverters, would likely have similar performance features as any installations within the next year or so, as shown in Table 4.1. Therefore, the analysis steps would be the same whether the June 2013 scenario or a more recent scenario is used. Using more recent values would show that the threshold limits are being reached as more recent installations are included.

DG resources included planned power purchase and distributed generation comprised of Net Energy Metering (NEM), Feed in Tariff (FIT) and Standard Interconnect Agreements (SIA). As the cluster evaluations are completed, the desire is to conduct the evaluation to a common reference

Hawaiian Electric Company

data to provide a baseline reference for the system. Future changes and upgrades that are required can thus be determined based a point of reference.

The capacity of future generators required to scale-up the total distributed generation to 135% of peak load is calculated and represented as distributed generators at the 12kV side of the 46/12kV transformers, along with the existing aggregated PV generators. The relative capacities and loads are given in Table 4.2. Note that the Peak and Minimum Loads specified in this table refer to the Cluster’s portion of the peak and minimum load across the whole HECO transmission system, while the generator capacities are calculated based on the Cluster’s specific peak load. This is the reason why the existing plus future generator capacity does not equal 135% of the peak load specified in this table.

Table 4.2. Cluster Load and PV Generation Scenarios.

Cluster	Peak Load (MW)	Minimum Load (MW)	Existing PV Generators Capacity (MW)	Future PV Generators Capacity (MW)
<b>Electrical Cluster A</b>	25.62	21.61	2.63	26.17
<b>Electrical Cluster B</b>	29.00	20.1	3.67	50.44
<b>Electrical Cluster C</b>	31.18	20.29	3.02	29.05

### 4.3 Analysis Process

Four analyses are performed, with the intention of capturing the extreme cases. These analyses are defined as follows:

1. Minimum load with no PV installed to establish a baseline reference.
2. Peak load with no PV installed also to establish a baseline.
3. Minimum load with PV equivalent to 135% of peak load.
4. Peak load with PV equivalent to 135% of peak load.

For analyses 3 and 4 above, the PV is separated into two categories – existing PV and future PV, as discussed above. For modeling purposes, there was a desire to investigate how different inverter settings impacted under-frequency trip response on the system. For this analysis, an assumption was made to leave all existing PV at 59.3 Hz trip setting and the future PV at the 57 Hz trip setting, as specified in Table 2.6. Since September 2013, new policy for inverter trip settings to conform to a 57 Hz trip requirement was adopted by the Hawaiian Electric Companies so this assumption may result in more aggressive PV system trips than what currently may occur now during an under-frequency event. However, as PV inverter systems are not monitored by the utility nor maintained similarly by residential customers in the same fashion, having an understanding of what the more aggressive response levels are helps gauge proper response and action for system reliability.

In each analysis the following process is performed:

- System is run in existing state up to 10 seconds with no disturbances imposed to check model stability;
- Largest generator (in this case the AES generator at 201 MW) is tripped offline; and,

- Simulation continues for 60 seconds and inverter trip and load-shed events are identified and quantified.

Within the timeframe of this effort, dynamic analysis will not include inverter re-closing (re-connecting after they have been tripped) operations up to 300 seconds of analysis. While this scenario is very important for understanding of system restoration after a generator trip event, it requires additional analysis that is beyond the timeframe of this study effort. This scenario is a critical dynamic study as part of high penetration PV impact analysis and will be conducted as part of the Proactive Analysis under continuing utility investigation efforts.

Other assumptions for modeling include:

- Instructions for load shedding (disconnection of customers to restore system frequency). Load shedding occurs when the frequency or voltage are outside the specified ranges for a specified period of time. The load shedding settings are as given in the transmission model prescribed by the utility based on critical loads and circuit loadings.
- The spinning reserve is specific to the fault event. In this case, the spinning reserve is the amount to cover the AES generator. The simulation covers the case where the utility would be able to source power from a back-up generator to cover for the loss of one of the generators on their transmission system. No spinning reserve is added to this to cover the PV which may be disconnected and no other generation is turned on after the simulated fault. This is based on the current assumption that the utility does not supply back-up generation for the distributed generation over which it has less control.

As the analysis proceeds, these assumptions may need to be further refined or changed and analysis can be rerun to compare results. Results obtained within the timeframe of this effort are based on the scenario described above and assumptions are presented.

#### 4.4 Results and Analysis

Results based on an initial run are presented in Table 4.3. In the Minimum Load case the installation of the PV generators showed no significant impact on changing the amount of load shed in response to a generator outage. Note that the PV generation tripped is equivalent to the existing PV generator capacity, and these are the only generators that were tripped.

Using the Peak Load condition, initial results showed that installation of PV generators caused less load to be shed than in the case with no PV generators, which is counter-intuitive as this would lead one to presume that installing more PV may have positive impacts on load shed. However upon further analysis, the modeling assumptions were unrealistic in terms of the actual operations including dispatch of the generators.

Table 4.3. Cluster Load and PV Generation Scenarios.

Load Case	Load Shed – No PV (MW)	Load Shed – With PV (MW)	PV Generation Tripped (MW)
<b>Minimum Load</b>	71.87	71.87	9.32
<b>Peak Load</b>	173.8	84.68	9.32

Further investigation of the initial scenario set-up and the frequency profiles shows that the result of less load shed at peak load condition is due to a modeling assumption that kept conventional generators running at reduced capacities and operating at un-realistically low levels where they were technically inefficient. In the simulation, when the N-1 contingency event occurs with the trip of a generator, these other generators are all running and have the response capability to increase their output, which prevented the system frequency from showing the necessary load shed response. This condition was further investigated by re-dispatching and de-committing 2 generators to compare this condition with the prior assumption.

An example analysis has been performed in which two conventional generators are selected to be turned off in order to accommodate the addition of the PV generators. The results – shown in Figure 4.2 - show that in this new case the frequency drops below the lowest frequency found in the other two cases, which suggests that load shedding would be equal to and likely higher than the load shed in the case with no PV. This is only an example of how the assumptions affect the results of this analysis, and should not be used to determine what dispatch should actually occur.

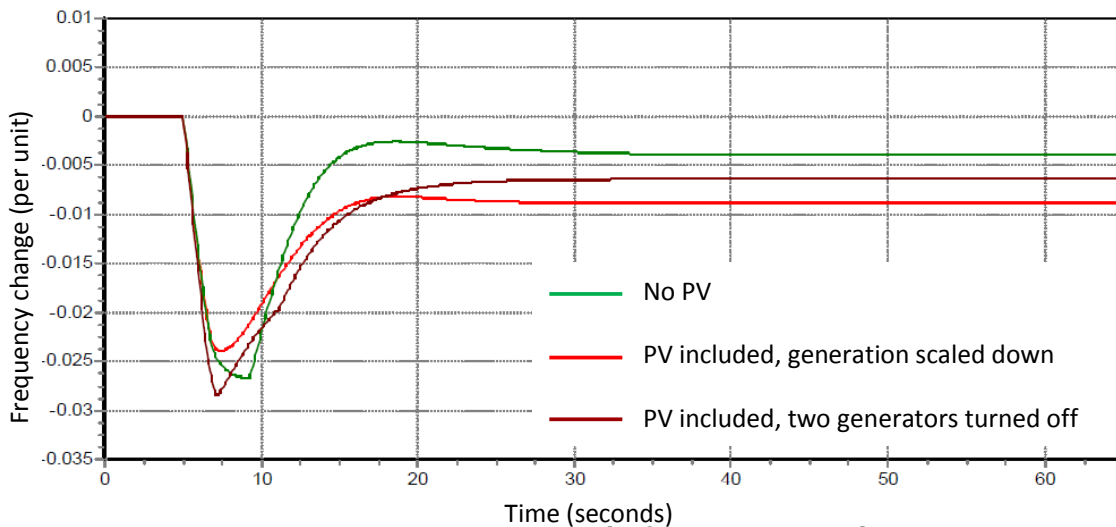

Figure 4.2. Frequency Results from Dynamic Analyses.

Based on this dynamic analysis, distributed generation does have an impact on system performance especially during contingencies such as the N-1 condition evaluated. Additional evaluation and careful consideration of the generator dispatch and contingency response of the system needs to be re-evaluated given high penetration PV impacts.

In this case (Figure 4.2), the results show that in the case with ‘PV with two generators turned off’, the rate of system frequency change shows the steepest slope compared to the other cases with ‘no PV’ on the system and ‘PV with generation scaled-down’. The ‘PV with two generators turned off’ also dips to the lowest point of the three analyses, which indicates that addition of PV in this case causes the same or more load to be shed compared to the case with ‘no PV’. Further investigation and evaluation by the utility’s planning department will be needed to ascertain appropriate levels of dispatch that also consider other contingencies not included in this analysis. These results highlight the importance of integrating distribution impact analysis on system performance as penetration levels increase. Impacts may be as far reaching as considering PV impacts on long range generation planning, on combination of units dispatched and on scheduling of utility generators for maintenance. Units available must also account for a new condition of variable PV

output and aggregated performance as distributed generators, in addition to the traditional consideration for ensuring adequate coverage of reserves and system inertia to preserve grid frequency during contingencies.

#### 4.5 Summary of Dynamic Case

The dynamic study presented here is performed to identify any impacts on load shedding due to increased installation of PV systems on the three clusters analyzed. The analysis is performed in peak load conditions, with and without PV in order to capture the extreme cases. In the cases where PV generators are included, they are modeled in two separate forms – existing and future generators – in order to capture the effect of differences in their under-frequency trip settings. In the main analysis, the PV generators are accommodated in the dynamic model by reducing the output of the conventional generators proportionally in order to maintain the balance between overall generation and load.

The results of the main study show that in this case – with the conventional generator output reduced across the system – adding PV generators has a positive effect in that less load was required to be shed. Further investigation shows that this result may be unrealistic and is dependent on how the conventional generation is modified to accommodate the PV generators. An example analysis is performed to assess the effect of changing this assumption. In this example analysis, instead of reducing the output from all conventional generators, two of the generators are switched off completely while the others remain at their original output.

Based on this dynamic analysis, distributed generation does have an impact on system performance especially during contingencies such as the N-1 condition evaluated. Additional evaluation and careful consideration of the generator dispatch and contingency response of the system needs to be re-evaluated given high penetration PV impacts. System events and DG monitoring is recommended to investigate if reliability issues are being encountered but masked due to limited monitoring of distribution level impacts and traditional modeling assumptions which may not adequately account for the impact of distributed generation in current planning practices. Re-evaluation of the system dispatch may be needed along with an update performance and response from conventional generators to accommodate variability impacts of distributed PV.

#### 4.6 Recommendations on Continuing Efforts

The dynamic studies carried out for the 3 clusters described in this report analyzed the existing Oahu transmission system for the following scenario:

- Peak load across the system;
- Largest generator trips offline (N-1 scenario);
- Baseline case with no PV installed; and
- Future PV case with PV up to 135% of peak load on the 3 clusters.

This future PV case represents one extreme scenario that could occur on the HECO transmission system and demonstrates how the Proactive Methodology can be used to consistently model the impacts of distributed PV and roll up to transmission level impacts as well as to assess future penetration conditions. To assess a broader range of possible worst case scenarios, it is recommended that work continues to include cases that consider minimum load conditions

throughout the year to account for seasonality and contingencies across the transmission system. By running these scenario-based analyses while holding investigative variables constant, it is possible to determine the range of responses of the system resulting from outages due to large generator trips, operational process change, load and DG penetrations. These scenarios help establish a set of baseline conditions and trajectory that can be monitored and tracked as conditions continue to change.

For the case of a large generator trip, this N-1 contingency case captures one operational scenario and baselines what could be impacted by the increasing PV interconnections. It is recommended that studies continue to be conducted on the Oahu transmission system to increase awareness that DG resource can cause on transmission and grid reliability operations. Additional studies include:

- A 3-phase fault at strategic locations on the transmission system: this analysis would simulate a short-circuit of a 3-phase conductor at critical locations on the system. During this condition, the short-circuit allows extremely large currents to flow in the system, and protection systems must be coordinated to respond correctly to ensure that any damage caused is limited as much as possible.
- Loss of major portion of solar PV on the system: this analysis capture ramp or voltage collapse events where a large part – or all – of the PV on the system is simultaneously disconnected. Analysis would investigate the increase in demand from the other generating units on the system, provide insight on system stability at low frequency conditions, and contingency response and restoration when operating under such conditions.
- Evaluation of effectiveness of load shedding schemes and spinning reserve requirements: during simulation of high penetration PV scenarios inclusive of ramping conditions for all of the described operational cases. Load shedding criteria and responsiveness of load shed programs should be analyzed to evaluate their effectiveness at alleviating the problems (e.g. under-frequency or over-voltage) given different penetration levels and varying distributed locations. Spinning reserve requirements – the backup generation that can be started up at short notice to cover loss of other generators, such as PV – can also be investigated to identify any necessary changes due to the increasing levels of distributed PV on the system.

Another aspect to be investigated in the transmission system study is the dynamic model used to represent the PV generators and inverters. The inverter model used in the study described in this report is a generic model provided in the software. While this model allows for inverter-based technologies to be represented, a generic model will not capture all the features or specific smart inverter performance of specific inverter manufacturers. It is recommended that as the Proactive Approach is implemented, that specific device models, such as from smart inverters, be captured as part of the model enhancement and model database maintenance updates. Similar to the transmission system, updated inverter models should be acquired from inverter manufacturers and developers and be maintained as part of the interconnection requirements for the utility. This will help ensure that the results obtained from modeling efforts are as consistent as possible with field device capabilities.

It is anticipated that adopting a continuous and timely process for completing these studies at varying levels of PV would provide awareness and baseline tracking of identified issues and potential risks due to increasingly high DG penetrations on the utility system. Furthermore, such analyses can help to provide recommendations on changes in settings or additional equipment required on the transmission system to maintain a reliable system in the presence of high capacities

of PV generation. This proactive practice is something that can not only help the Hawaiian grids but all utilities contending with high penetration issues and to proactively manage and assess mitigation needs.



## 5.0 Mitigation Measures

The studies on the impacts of high distributed PV penetrations on the distribution feeders, substations and transmission lines have concentrated on

1. Determining PV penetration thresholds and likely exceedance limits based on technical criteria that can help mitigate adverse impacts on the security, reliability and stability of the grid.
2. Once the thresholds and limits to PV penetration are reached, the question is how much can be afforded and should be done to upgrade and mitigate impacts to further accommodate PV.
3. Based on mitigation studies determine practical solutions based on cost and benefit.

If cost effective mitigation measures can be determined that also improve reliability and stability and facilitate increased PV penetrations, they should be prioritized and pursued.

As solar generation mostly impacts the midday time period between 10am and 4pm, atmospheric conditions, such as cloud formations, that generate variability in solar generation need to be accounted for. Effective mitigation measures using advance solar and wind forecasting by Hawaiian Electric Companies are currently being pursued [5, 6, 7] and are being piloted with federal support to reduce system impacts and facilitate increasing renewables on the system [8].

Some of these measures may require additional controls to be installed at the customer side to better manage solar systems while others require increased capital investment in infrastructure to upgrade monitoring, protection and telecommunications for transferring data in real-time. To make these measures acceptable to utilities and ratepayers requires universal support, despite monetary impacts.

The types and magnitude of mitigation measures are dependent on the circuit configuration, customer mix and PV penetration as the studies have shown. This section lays out some mitigation options, their pros/cons and how modeling analysis can be used to evaluate options. Using the Proactive Analysis, a demonstration of how simulation based studies can be used to evaluate some new technologies, consider cost-effective measures and identify locations to strategically demonstrate, deploy and capture conditions (steady-state and transient) needed to manage high penetration impacts. The proactive and investigative feeder analysis work being conducted today lays the framework for determining and implementing mitigation measures for future robust operations.

As maximum thresholds for PV penetrations are reached, scenario-based studies can also be used to assess expansion needs and evaluate broader mitigation measures as the grid modernizes and changes. New technologies that are appropriately modeled can then be simulated for their effectiveness without sacrificing the reliability and performance of the existing system.

### 5.1 Mitigation Options and Tradeoffs

Table 5.1 shows a partial list of potential mitigation measures that could be implemented under steady-state and first contingency conditions. The list may likely expand to capture other mitigation measures considered as similar transient and dynamic studies are performed.

Table 5.1. Listing of potential mitigation measures.

Mitigation Measure:	Applicable Adverse Condition:						
	Voltage High	Voltage Low	Backfeed	LTC Cycling	High Fault Current	Feeder Over Loads	
<b>Level voltage and lower LTC settings</b>	X	X					
<b>Capacitor relocations</b>	X	X					
<b>Energy Storage</b>	Located on Feeder	X	X	X			
	Located on Residential or Commercial Site	X	X	X		X	
<b>Inverter curtailments</b>	Clipping voltage	X					
	Turning off inverters	X		X			
<b>Regulating Transformers</b>	Voltage	X	X				
	Reactive power	X	X				
<b>Inverter functionalities</b>	Voltage	X	X				
	Frequency						
	Reconnect times	X	X				
	Reactive power	X	X				
	Solar power ramping	X					
<b>Upsizing distribution transformer</b>						X	
<b>Increase secondary cable sizing</b>						X	
<b>Adding distribution transformer &amp; splitting load</b>						X	
<b>Protection upgrades</b>				X	X	X	
<b>Demand response-turning on equipment</b>	AC		X	X			
	Water heaters		X	X			
	EV		X	X			
<b>Demand response-turning off equipment</b>	AC	X				X	
	Water heaters	X				X	
	EV	X				X	

As discussed in the previous sections, PV penetrations impact system conditions at different percentage levels. For example, the PV penetration level required to impact fault current is different than the PV penetration to cause backfeed. As each of these penetrations is reached, there are certain mitigation measures that could reduce or eliminate the problem. Not all of these mitigation issues solve the same problems. For each cluster analyzed above, the mitigation measures are studied one at a time to determine which measure solves the feeder problem, and at what cost. Then the PV can be increased until the next problem is found. This iterative process continues until all of the problems are solved and a new maximum PV is determined. It is probable that the mitigation costs will be prohibitive before all of the reliability issues are solved.

Hawaiian Electric has begun studying and evaluating each of these mitigation measures [9, 10]. As the studies are completed, the reports will be expand the current knowledge base on addressing high penetration needs and also help to explain the costs and economic benefits of various mitigation strategies. As cost values become available, they should be added to each mitigation measure consideration as noted in Table 5.1.

Each of these mitigation measures provides different values to both the utility and the distributed PV owner. A brief description of each is listed below.

Level voltage and lower LTC setting – The utility conducts power flow simulations to determine the optimal place to install line capacitors or line regulators to levelize the distribution voltage across the distribution feeder and the secondary service drops. This allows the utility to lower the voltage at the substation bus so that the LTC operates to a lower bus voltage.

The utility would need to check the required voltage regulation under different customer loads and PV penetrations to determine when the capacitors would need to operate. The utility would also need to verify that this LTC setting does not impact the other distribution feeders on the same bus.

Pros:

- Reduces voltage overloads created from high PV penetrations
- Reduces LTC operation by maintaining a uniform voltage across the feeder by reducing variability of voltage
- Could be an economical solution given the lower cost of capacitor banks compared to other alternatives

Cons:

- Increases current flow on distribution feeder and increases line losses
- Can cause low voltage on other distribution feeders connected to the same bus
- Setting of capacitor operation for varying seasonal load could be complicated due to the large number of capacitor banks installed. This requires maintaining a record of every capacitor and developing a comprehensive maintenance schedule. The periodic switching of feeder segments for maintenance or outage conditions could result in the capacitor banks operating incorrectly. May need to have periodic checking of capacitor size and location as PV increases

Capacitor re-locations – This is a function that is periodically conducted by the planning departments. The distribution feeders are simulated to determine if the current capacitor and regulator settings are still appropriate. These periodic studies would be expanded to study various distributed PV penetrations to determine how the capacitor locations could change with load growth and increasing PV penetrations. This analysis would also require conducting protection studies to determine if the coordination between capacitors, substation equipment, and line fuses are still correct. This study will investigate the current locations of capacitor banks and where to locate the capacitors if existing locations are creating problem issues. The study results could then be used to describe the before and after results of locating the capacitors.

Pros:

- Can be a quick and easy fix to voltage issues

- Development of written protocols and seasonal settings could enable the maintenance staff to easily track the location and settings to schedule required maintenance and capacitor operational changes.
- Would not impact other distribution feeders on same substation bus

Cons:

- Control logic may need to be more sophisticated compared to current logic, hence, requiring more data. For example, the simple setting of fixed and time based may not be accurate enough. The settings may need to be upgraded to provide for more flexibility to operate as the PV output varies by season and load.
- Requires yearly assessment on the capacitor locations and control logic
- Requires seasonal inspection and re-setting of controls

Energy storage – Types of energy storage installations can include those located on the distribution and/or subtransmission feeder and those located at the residential or commercial site

Energy storage devices allow for the storage of excess energy to be used to regulate solar variability and reduce backfeed onto the distribution feeder and substation bus. These devices provide local control to regulate a limited service area. Solar developers are offering storage/solar installations currently. Battery standards and impact on system will also need to be considered. Long term viability of chemistry based batteries also needs to be resolved.

Pros:

- Reduces backfeed onto distribution feeder and substation bus
- Reduces fluctuations in generation from solar variability
- Provides additional generation when needed
- Can be used to control a wider range of voltage issues when installed on distribution feeder

Cons:

- Controlling residential and commercial storage is an issue since the storage devices are located behind the customer meter. Storage controls could be unavailable.
- Cost of storage is very high. A 1 MW device could cost over \$1.5million.
- Lack of track record of diverse commercially available storage options. The types of commercially available battery types with long track records are currently limited. There are many being tested in laboratories and at beta test sites but not very many commercial.
- Safety and security is an issue. The failure of lead acid batteries can cause fires, emit toxic fumes and other harmful elements.
- Waste and disposal of chemistry based batteries need to be considered.

Inverter curtailments – Since there are limited times during the year when PV inverters can create high voltage on the distribution feeder, the utility could add operational logic to the inverter controls to regulate the operation of distributed PV installations. Considerable efforts are being discussed by IEEE and industry on standardizing inverter settings to limit power output so as not to create high voltage. When the voltage at the customer meter reaches 125 voltages, the inverter will limit solar generation to the value until the voltage reduces. The utility could also setup controls using the smart meters to control the operation of the inverter, even shutting the inverter off.

- Option 1: set an upper voltage limit (clipping voltage) on the inverter to maintain a pre-determined voltage level by limiting or reducing PV generation. The control limits PV generation through voltage settings.
- Option 2: Install remote controls on every distributed PV installation to allow the utility to turn the PV inverters on and off to control voltage.

Hawaiian Electric Company

Pros:

- Uses internal inverter logic to control voltage (Option 1), if available
- Could be a quick fix to high voltage conditions on the distribution circuits (Option 1)
- Enables utility operators additional generation controls for incident occurrences (Option 2)
- Curtailing PV generation could be a short term option but longer term strategies need to be considered from customer perspective including duration of curtailment and repayment.

Cons:

- Reduced energy output for PV owner (Option 1, Option 2)
- High cost for controls (Option 2)
- Lack of permission for utility to control customer-owned PV systems (Option 1, Option 2)
- Requires annual updates of PV installations, voltage set points and cost impacts (Option 1, Option 2)

Regulating transformers – Regulating transformers can be installed either on the secondary service drops or the distribution feeder at strategic points to regulate voltages and reactive power. Demonstration projects are being conducted on utility systems to test for operation and functionality. A regulating transformer is a standard utility transformer with regulator solid state controls. If there is an existing transformer in the field, the solid state regulator could be interconnected with the transformer to make a regulating transformer.

Pros:

- Commercially available regulating transformers are now emerging on the market and being tested by utilities in the near term as compared to other options such as batteries, fuel cells, utility controlling customer equipment.
- Controls can be attached to existing pad mount or pole mounted distribution line transformers
- Equipment costs could be very economical since the regulating equipment can be installed on existing transformers
- Time to install and maintain could be low compared to other options. For example, the utility would not be required to be field checked every season or every year as the case for capacitors.

Cons:

- Full life-cycle and maintenance costs are unknown
- Could require high utility maintenance to check a high volume of secondary service installations
- Data delivery to control center could result in high cost upgrades to monitor efficiency. If every transformer requires separate communication equipment to send information back to the control room and then every data sent (1 second, 1 minute, 5 minutes and so on) requires larger storage capability

Inverter functionalities – There are at least five new functions to improve the inverters participation in maintaining reliability and security. These include controlling voltage, controlling frequency, providing reactive power, limit solar power ramping, and staggering reconnect times after incident events. The current inverter logic may not currently have these functions available and a future inverter upgrade would be required. These are not commercially available yet and are only being studied to determine their capability and benefits.

Pros:

- Provides each inverter with its own internal control mechanism

Hawaiian Electric Company

- Reduces utility intervention to control
- Provides utility with increased reliability, security controls and options

Cons:

- May require inclusion in the next inverter logic upgrade
- Could violate current rules and regulations
- May require additional data to automate controls or new inverter logic and a determination of who is paying for these functions.
- Equipment costs may increase if there are new control functions
- Adverse impact to existing circuit protection schemes. Having a large number of inverters changing feeder values while other equipment is also changing values could result in unnecessary equipment trips and unit failures. Even if a system could be designed for one feeder, if feeder segments are switched to other feeders for maintenance or outages, there is no guarantee that the systems would continue to operate properly.

Increasing distribution transformer size, increasing cable sizes, adding distribution transformers and splitting load, protection upgrades – These options are utility modifications to the feeder and the secondary service drops and need to be considered as part of larger grid modernization needs. The utility can implement these without PV owner participation or changes in the inverter logic or operation. The upgrade costs will increase with current and future levels of PV, and determination of a ratepayer structure to cover these costs will need to be addressed. These potential solutions will not work for every feeder and penetration scenario, and will require a detailed study for each feeder with distributed PV.

Pros:

- Does not require PV owner participation
- Utility can study and plan for future upgrades based on projected penetration levels
- Does not require changes in inverter logic

Cons:

- Increases capital investment by utility
- Requires shared payments from PV owners to cover the increased investment
- Is a short term fix with high cost

Demand response options – The utility could implement various demand response options that turns on or off certain residential or commercial equipment during critical periods. Depending on the load versus solar capacity, the demand response may need to turn on equipment or turn off equipment.

Pros:

- Does not require major equipment upgrades from the utility
- Increases control of load instead of solar variability which is easier to implement

Cons:

- Ratepayer must agree to having behind the meter load controlled by the utility
- Could impact utility revenue
- May create a diminishing return or value as options are implemented. A perfect example is the controlling of air conditioners. Customers could be open to having their AC controlled during high ambient temperatures for a while. However, customers could lose interest due to the small amount of funds that they would receive during high temperatures. Hence, they would soon realize that the payments are not high enough for them to sit in their homes being hot.

Hawaiian Electric Company

- Lack of visibility to available demand response loads
- Lack of communication infrastructure
- Lack of backhaul and analysis infrastructure with appropriate controls by utilities

## 5.2 Options Applied to Clusters

Based on analysis conducted and results for each of the electrical clusters described in Sections 3 and 4, mitigation analysis and some technology options are considered. The examples provided below demonstrate how advance modeling introduced as part of the Proactive Modeling Methodology can be used to identify conditions, track issues, increase awareness, evaluate effectiveness of new potential technologies to address issues and assess cost-benefits of varying approaches. While further investigation and pilot demonstration to field test new technologies will be needed, accurately modeling to show effectiveness and cost-benefits shows commitment and a basis to inform actions.

### 5.2.1 Electrical Cluster C - Loading

For Electrical Cluster C, a conductor overload condition was identified during the model evaluation on sections of Circuit CC7 that starts to occur at around 127% PV. The overloaded sections are highlighted in Figure 5.1. The section colored in red in the plot has a utilization (amount of rated current capacity used) across the three phases of 108% (balanced) when the PV penetration is 135% and the minimum load is used. Note that this overload does not occur at existing PV penetrations. As part of the Proactive Modeling, PV penetrations levels were systematically increased through 135% so as to identify “hotspots” and their locations. The peak utilization is for Circuit CC7 is 133% on one phase (Phase A) of the 3-phases. This conductor type is currently specified as #4 AAC OH.

To mitigate the overload, one of the simplest methods of mitigating a conductor overload is to replace the conductor, however there are cost and outage considerations to be factored in. In this case, the type of conductors on either side of the overloaded section can be identified and compared to the overloaded section. Based on review of the updated modeling equipment database and conductor segment information, the overloaded segment has a conductor (#4 AAC OH) size rating that is smaller than the sections around it (336.4 AAC OH), which has higher rated capacity. As such, if this overloaded section is upgraded to a higher rating similar to the surrounding conductors (336.4 AAC OH), the utilization drops to 38% balanced, and 47% on phase A, and the overload is therefore removed.

The orange overloaded sections in the plot do not have an overload in the balanced case, but Phase A has a utilization of 124%, which is flagged as potentially high and a condition to track. Based on the models, the same mitigating solution can be applied to these conductors, and the utilization is reduced to 43% on Phase A.

If all of these conductor upgrades are completed, the total length that would have to be upgraded is 1497 ft. Using an assumed cost of \$500/ft (actual value to be confirmed), this would require a capital expense on equipment of around \$750,000, plus additional time and customer outages to accommodate reconductoring of the lines.

As this type of overload occurs due to the PV output at high penetrations, and is exacerbated as PV output increases, another mitigation solution may be to implement inverter curtailments.

Assuming that curtailing individual PV inverters is technologically feasible, if system operator orders curtailments and assuming PV system owner are agreeable under some agreement for cost energy due to curtailment, the relative costs for this type of curtailment mitigation can be evaluated. An example day has been used to calculate the relative costs of upgrading the conductor versus the cost of curtailment. In this case, an assumed lifetime of the conductor replacement of 50 years is assumed, in order to calculate the cost on a per day basis. Results are summarized in Figure 5.2.



Figure 5.1. Overloaded sections on circuit CC7.



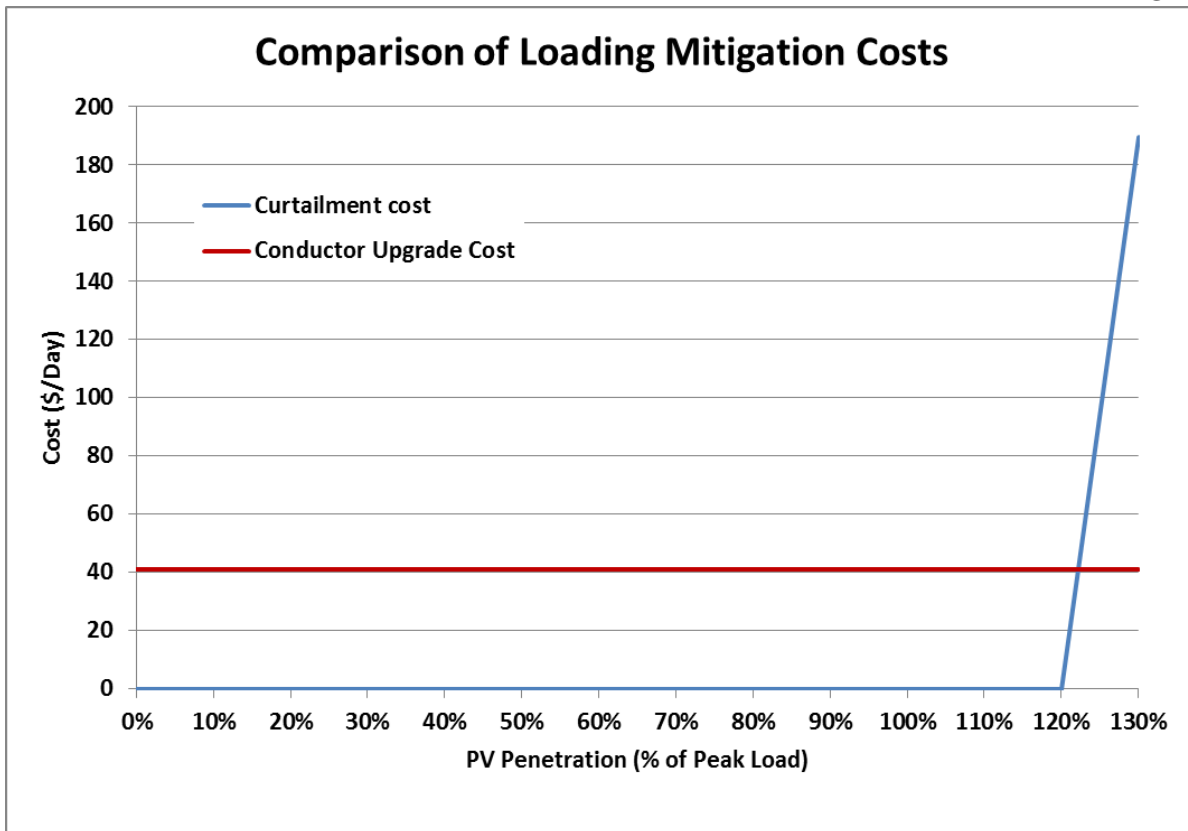

Figure 5.2. Comparison of mitigation costs for thermal overload.

In this case Figure 5.2 shows that the cost of replacing the conductor is significantly cheaper than paying for curtailed energy once the problem starts to occur. However, the loading problem only occurs at relatively high PV penetrations, so until that point no costs need to be incurred for either solution.

Such evaluations can be systematically applied across the Oahu system to identify conductor overload conditions and quantify the costs and prioritize need based on penetration levels for each of the feeders.

### 5.2.2 Electrical Cluster B – Fault Current Rise

For Cluster B, the 5% and 10% Fault Current Rise represent some of the lowest limits identified on these feeders. These limits are included as screening criteria in the existing Rule 21 interconnection procedures, and HECO’s Rule 14H. Understanding that tariff modifications are currently in discussions, at the time of this report, exceeding these limits would trigger further study of the short circuit interrupting capacity of the protection equipment.

Figure 5.3 below shows the limits on PV penetration identified for the Electrical Cluster B.

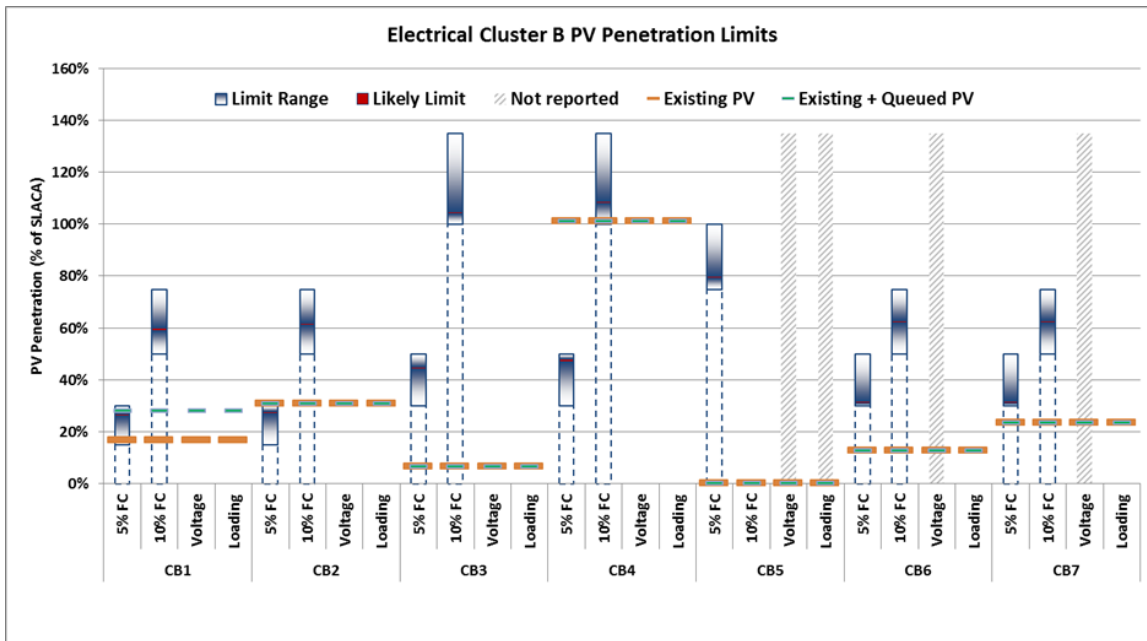

Figure 5.3. Electrical Cluster B analysis results.

A trigger for upgrading protection equipment is that the available fault current exceeds 87.5% of the interrupting capacity of the circuit breakers. Interrupting capacity of the circuit breakers on the Oahu system still needs to be confirmed however for purposes of this analysis and within the timeframe of the evaluation, an assumed value of 25000 Amps has been applied. This value represents the maximum loading at which the device can continue to function as protection for the circuit. If the fault current were to exceed this value, the protection equipment may not provide protection and extensive damage to interconnect equipment can occur on the circuit.

The maximum fault current on the Electrical Cluster B circuits has been calculated at 6761 Amps at 135% PV. This is 27% of the assumed interrupt rating, so in this case no further mitigation would be required. If the installed PV did cause the interrupt rating of the protection equipment to be exceeded, the only option is to upgrade the protection system, so no comparisons are provided in this case. This is a modeled example of implementing protection upgrades to mitigate high fault current. Referring back to Table 5.1, there are presently no other readily viable alternatives to mitigating high fault current on utility side other than to minimize their occurrence.

### 5.2.3 Electrical Cluster A - Backfeed

To deal with the problem of reverse power flow, several options are available. The least expensive, from a capital expenditure perspective, is to curtail the output of the PV systems in proportion to their installed capacity so that the reverse power flow does not happen. The cost of this is the cost of the energy that would have been produced if the curtailment had not been imposed, which increases with increasing PV penetration. Calculating this cost over a year would require large amounts of irradiance and load data, and these are not available for this report, so this method is only addressed for the minimum load day to provide a comparison with the energy storage option discussed in this section.

Another solution is to increase the load on the system by remotely turning on electrical equipment, offsetting the excess energy produced by the generators. One proposal has been to use pumps in the water system for this purpose, which would require some level of expenditure for the integration between the electrical and water utilities as well as investment in new systems. Another possibility in future is to allow certain household appliances (e.g. dishwashers) to be turned on by the utility when necessary during the daytime. However, this would also require investment in communications equipment to make the remote operation possible. The advantages of these demand-response solutions over the curtailment solution are that no energy is lost.

The third mitigation solution is to include energy storage systems either at the customer level or at the sub-station. This would allow excess energy from the PV systems to be stored and used when PV systems turn off during hours of darkness. This would also have the advantage of smoothing out the evening peak energy demand for conventional generation and reducing the demand ramping commonly seen on residential distribution feeders as the PV switches off. This constitutes the most flexible option for the utility as the battery can be switched on or off as necessary. However, it may also require significant capital expenditure.

The fourth option is to upgrade the voltage regulation system at the transformer. As discussed earlier in this report, the main technical problem caused by reverse power flow is that the voltage regulation system at the transformer is not normally set up to recognize the direction of current flow, and only measures the magnitude. This means that when the current flows in the opposite direction the voltage regulation system will use the incorrect logic causing a feedback loop and continually worsening voltage problem. The voltage regulation equipment can be upgraded to sense current direction and reverse the control logic, thus removing the problem of reverse power flow.

The analysis below calculates, for the minimum load day only, the peak reverse power flow and the total energy fed back to the transformer. Subsequently, the cost of an energy storage system and the cost of curtailing the customers are calculated, and these are compared against the cost of upgrading the voltage regulation system to identify the most cost-beneficial option.

Figure 5.4 below shows an example of how the battery could be used.

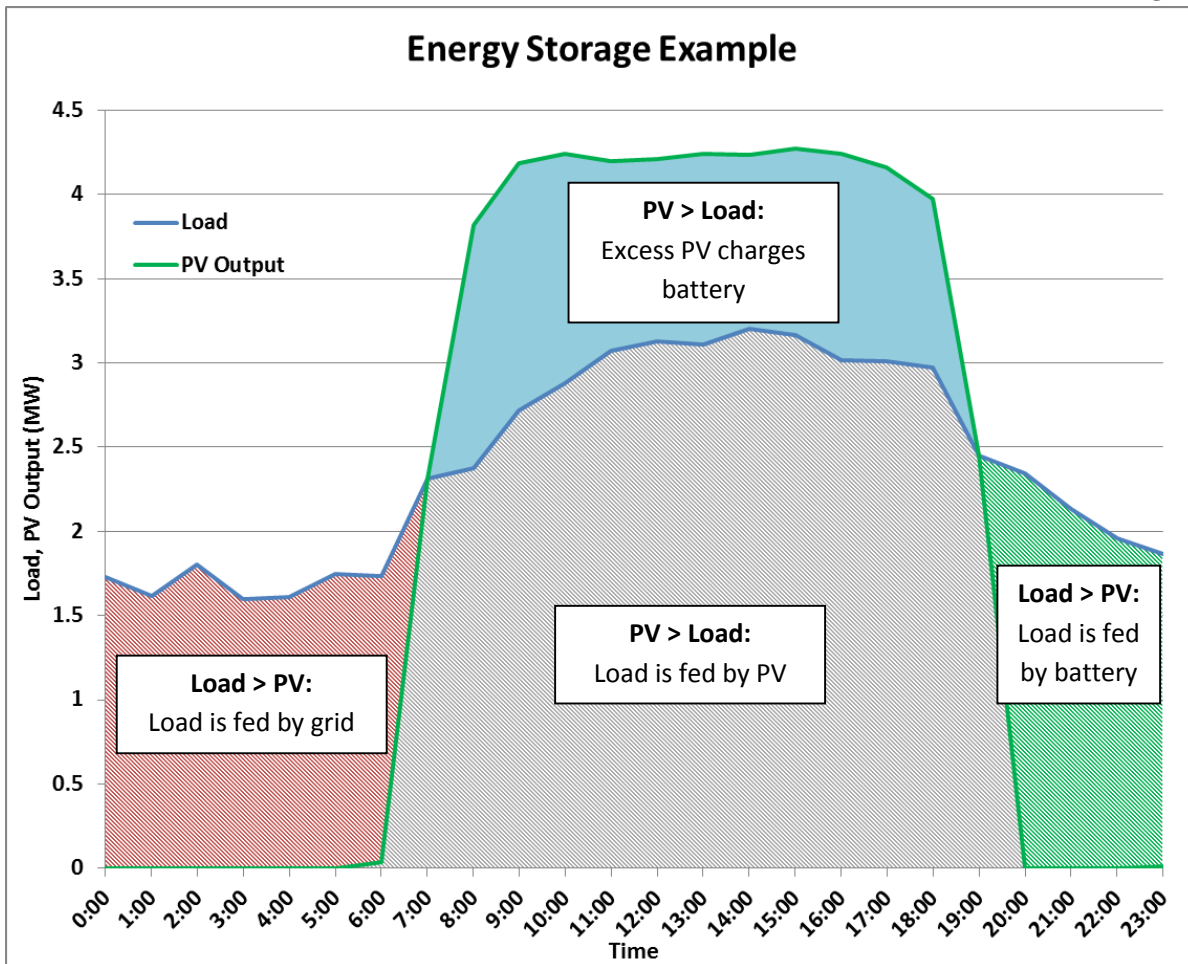

Figure 5.4. Illustration of how storage functionality needs to change due to changing load and PV throughout the day.

The chart is broken up into 4 areas:

- In the red area from midnight until 07:00, the load is greater than the output from the PV, so the customer load is supplied using energy from the grid, as in the conventional approach.
- In the grey area from 05:00 until 20:00 the PV output comes online during the hours of daylight. At this point the load is supplied by the PV output (and from 05:00 to 07:00, by a mixture of PV output and grid output).
- The blue area at the top represents the excess of PV output that is produced above what is needed to serve the customer load. This excess is used to charge a battery, rather than contributing to reverse power flow on the distribution system.
- Finally, the green area on the right represents the time when the PV output is less than the load, after sunset. At this point, the battery which was charged during the daytime is used to supply energy to the customer.

Figures 5.5, 5.6 and 5.7 below show the peak backfeed for each PV penetration on each feeder, the total storage capacity required, and the estimated total cost of the storage solution.

The cost of a battery system is based on the peak rate at which the battery is charged (which is represented by the peak amount of reverse power, or backfeed, on the distribution system in kW), and the peak storage capacity in kWh. For reporting purposes, the cost is calculated using capital cost and Operation & Maintenance (O&M) costs from the EPRI report “Cost-Effectiveness of Energy Storage in California” produced for the CPUC in June 2013. As cost values are developed for Hawaii, these values can be updated to reflect specific costs. In general however, the values are representative of state-of-the-art storage technologies and reflect current technology costs estimated at:

- Capacity Cost: \$528/kWh
- Charge Rate Cost: \$15/kW per year over a 20 year life

Other costs such as Variable O&M cost and replacements should also be factored in. However, to capture specific variable O&M cost would require significantly more localized load for Cluster A and irradiance data in order to find the total kWh stored over a year. To provide a sense and conservative order of magnitude on costs of storage, the variable O&M cost details were not included in the calculation.

The Peak Backfeed and Total Energy Storage charts above can also be used to inform any demand response and curtailment solutions described earlier. These values represent the kW load and total kWh to be offset that would be required of remotely operated machinery.

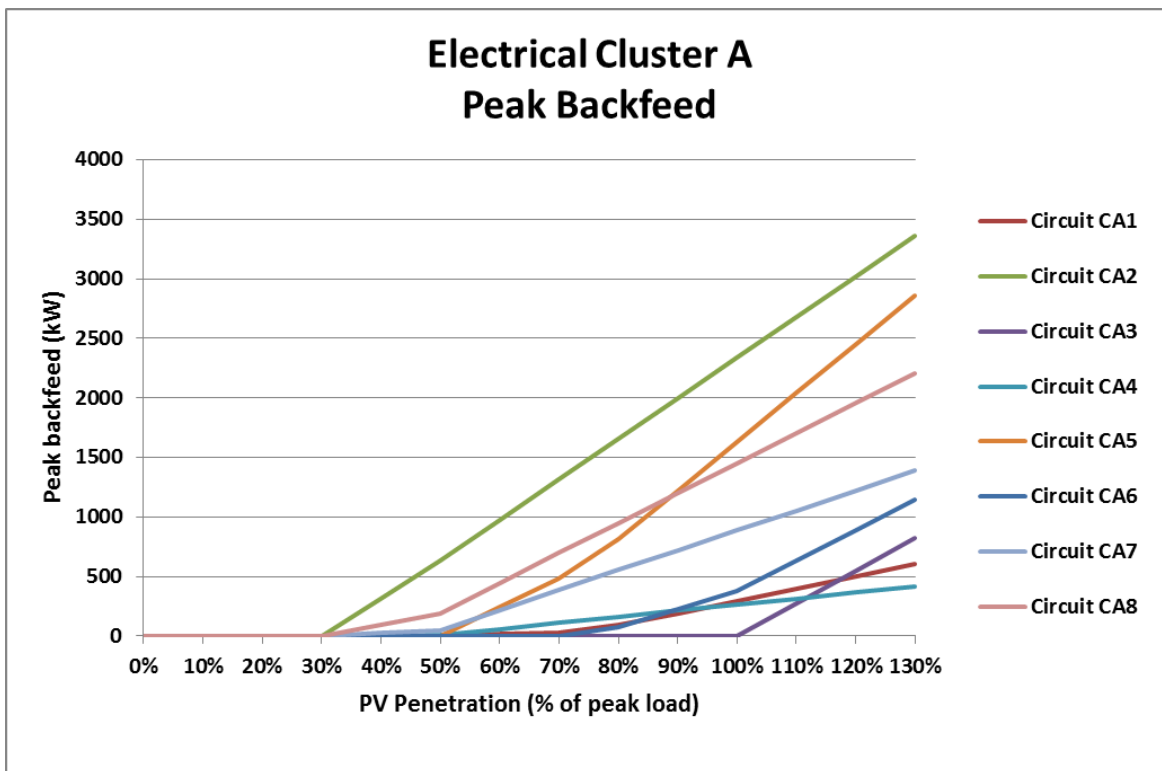

Figure 5.5. Peak backfeed vs PV penetration for circuits on Electrical Cluster A.

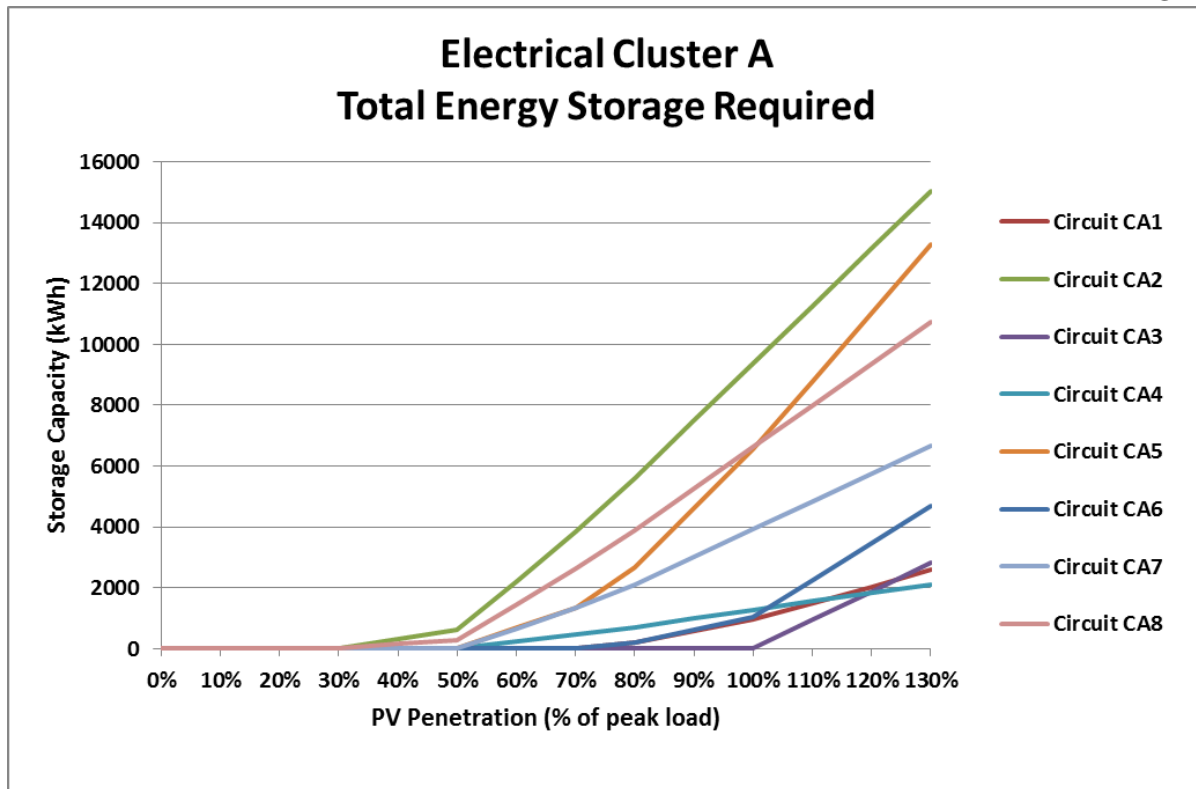

Figure 5.6. Total energy storage required per day vs PV penetration for circuits on Electrical Cluster A.

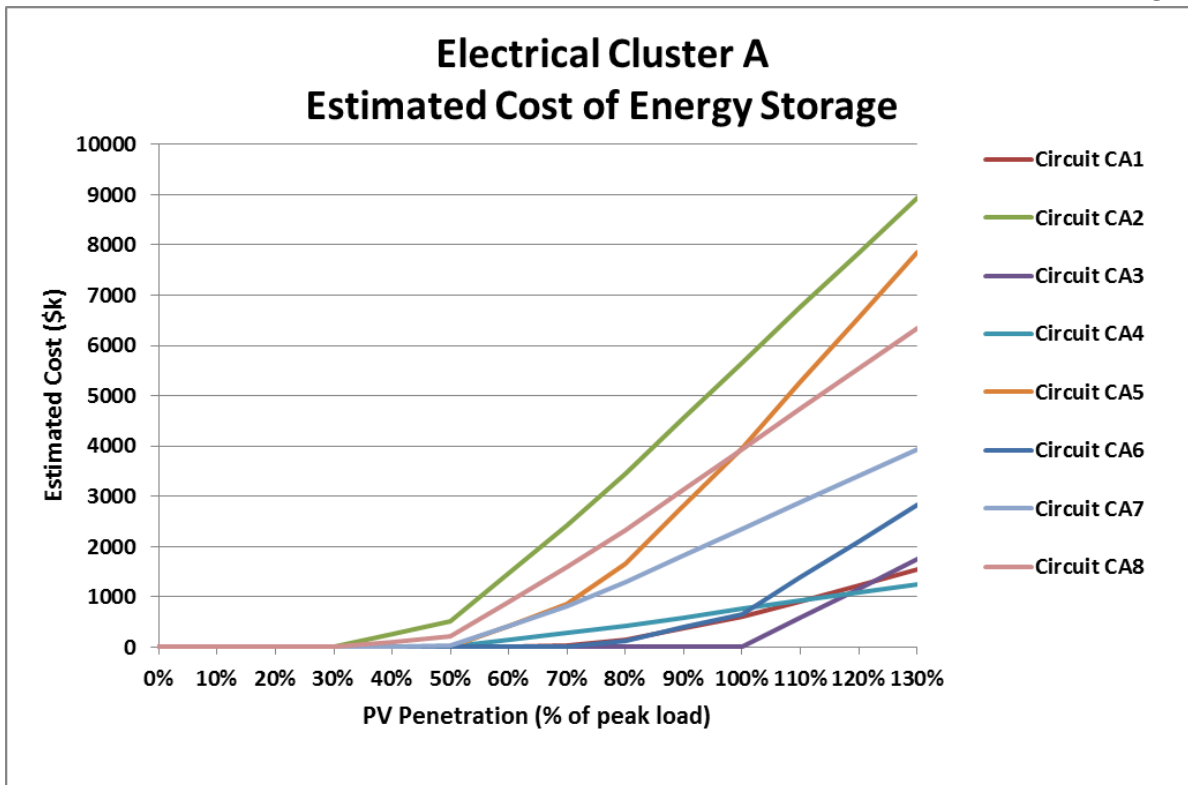

Figure 5.7. Total cost of energy storage vs PV penetration for circuits on Electrical Cluster A.

An example of how all of this data can be used to identify the most cost-effective mitigation strategy is shown in Figure 5.8 below. In this chart, a cost has been assumed for curtailed energy – this represents the price that the PV system may require for the energy lost when they are requested to disconnect their system in order to prevent reverse power flow. In this case, the price has been assumed at \$0.05/kWh. A cost has also been assumed for the upgrade of the voltage regulation equipment, set in this example as a fixed cost of \$500,000. The equipment upgrade cost is based on the existing distribution configuration which includes transformer and both circuits connecting to the transformer. All costs have been calculated on a per day basis, which means that the total costs of the energy storage solution and the transformer upgrade solution have been divided by the expected lifetime of 20 years.

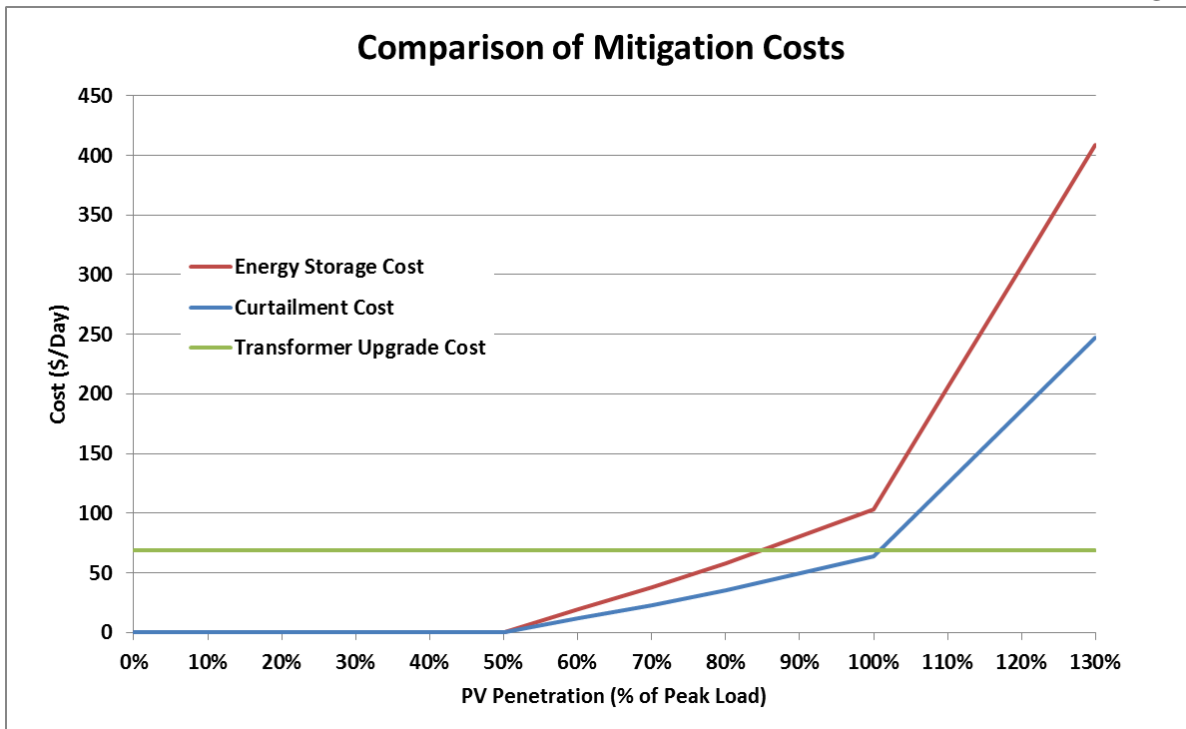

Figure 5.8. Comparison of mitigation costs for backfeed.

Based on cost assumptions discussed, Figure 5.8 shows that the transformer upgrade ends up as the least costly solution at PV penetrations above 100%, while paying for curtailment is the least costly up to about this point. There are two important notes to make about this result:

- These results are highly dependent on the assumed inputs. For example, if the price for curtailed energy is increased from \$0.05/kWh to \$0.1/kWh, the curtailment solution becomes more costly than the energy storage solution;
- The cost of the energy storage solution does not take into account other potential benefits, such as reducing the evening ramp of load that generally occurs as people get home from work, in conjunction with the drop in PV output. This ramp in load requires the utility to ramp up the output of their conventional generation. Using energy stored in batteries during the day could help to alleviate this problem, and could avoid costs associated with maintaining conventional generators just for this load. As this benefit is difficult to quantify, for simplicity it has been left out of the above example.

While the three mitigation examples in this model are dependent upon various costs as to when one becomes more cost effective than another, the characteristic of the Regulating Transformer example shows that there is a threshold of PV penetration above which it is highly cost effective. If the rest of the system can use the energy, then the transformer upgrade solves the Backfeed issue. However if there is no area that can use the energy, then curtailment or storage are the only options. Note that the cost effectiveness is similar to the loading example where once a threshold was reached, hardware upgrades were much more cost effective than curtailment, albeit at high PV penetration values.



### 5.3 Assessing New Distributed Voltage Regulating Mitigation Technologies

One mitigation example that Hawaiian Electric Company is currently looking to implement as a real world solution, is a GridCo integrated power regulator (IPR) [11]. The objective of the project is to investigate the effect of the dynamically controllable regulator on the projected high voltages at or closer to the locations with distributed PV generators on the low voltage side of the distribution transformers. Current configurations have such protective devices up at the utility substation which can often be ineffective when PV voltage issues are at end of line and costlier to fix from that location.

The results from the study show that the voltage at the customer locations would exceed 126V (on a 120V basis), which is a violation and may result in inverters tripping offline depending on their trip settings and the duration of the violation. Using the Gridco IPR, the voltage remains roughly constant at the customer location as the IPR taps down through the increase in PV output and therefore a voltage violation on the low voltage circuit is avoided.

#### 5.3.1 Low Voltage Model

The location of the study with the regulator is on a single-phase section as shown in Figure 5.9 below.

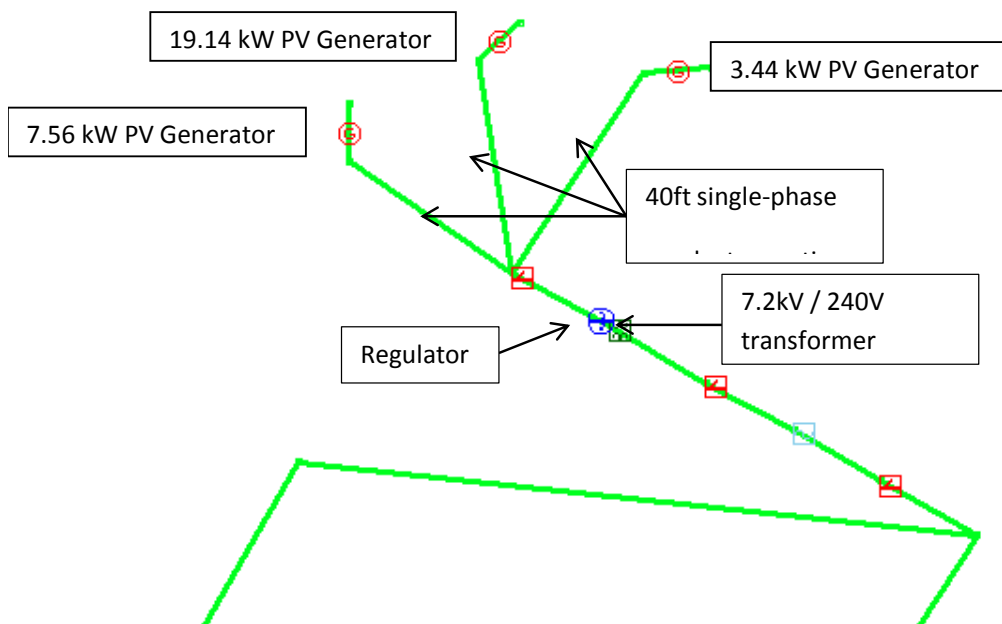

Figure 5.9. GridCo IPR system model.

To model the low voltage sections a single-phase 7.2kV/240V transformer is placed into the model with generic properties. The Gridco IPR is placed on the low voltage side of the transformer, on the same conductor section. The three existing generators represent PV generators with a power factor of 1.0, and these are connected to the transformer by separate 40ft conductor sections.

### 5.3.2 Time-Step Analysis

A time-step analysis is conducted in SynerGEE to determine the effect of the regulator on the maximum voltage in the system, shown above, due to its ability to operate on a continuous basis without the LTC time delay in the substation primary transformer. The simulation utilizes 24 time-steps, with each step representing 2 seconds of real time. The time period selected represents the maximum ramping condition when the rapid increase in PV output creates potential voltage violations. During the analysis, the feeder equipment settings and load are maintained constant.

The first time-step simulation is with the primary substation transformer LTC operating automatically in order to set the initial conditions. For all subsequent time-step simulations the LTC is fixed in the same position to simulate the condition where PV output changes occur within the time delay of the LTC. The time delay on an LTC is the minimum time period allowed between LTC position changes. The reason for having a time delay on this voltage regulation equipment is to prevent it from making rapid adjustments which would cause irritating changes in voltage on the rest of the system, and significantly increased wear on the LTC equipment. Only the output of the PV generators is modified in the analysis, in direct proportion to the change in measured irradiance on the day selected. The irradiance profile used is shown in the Figure 5.10:

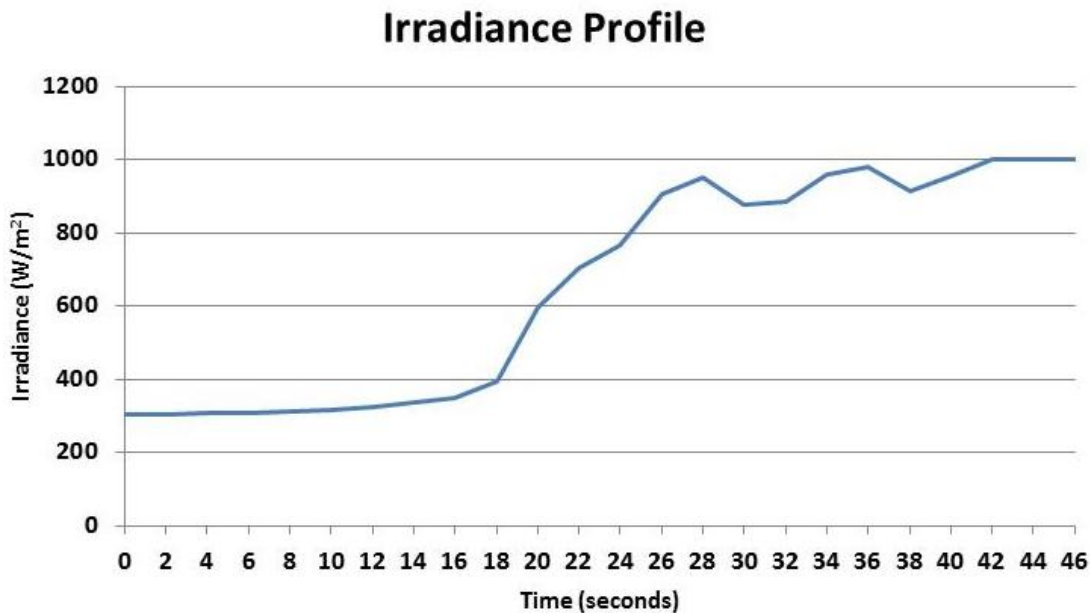

Figure 5.10. Irradiance profile used for maximum solar ramping condition.

The analyses simulate the case with the regulator turned off to define the base case voltage profile during the time period, and then with the regulator turned on to identify the effect on the voltage profile.

### 5.3.3 Summary of Distribution Level Voltage Regulating Technology Analysis

The results of the analysis are shown in Figure 5.11 below. Note that the voltage curves (green and purple lines) are referenced to the left axis while the regulator tap position (red line) is referenced to the right axis.

### Voltages on M3 During PV Ramping

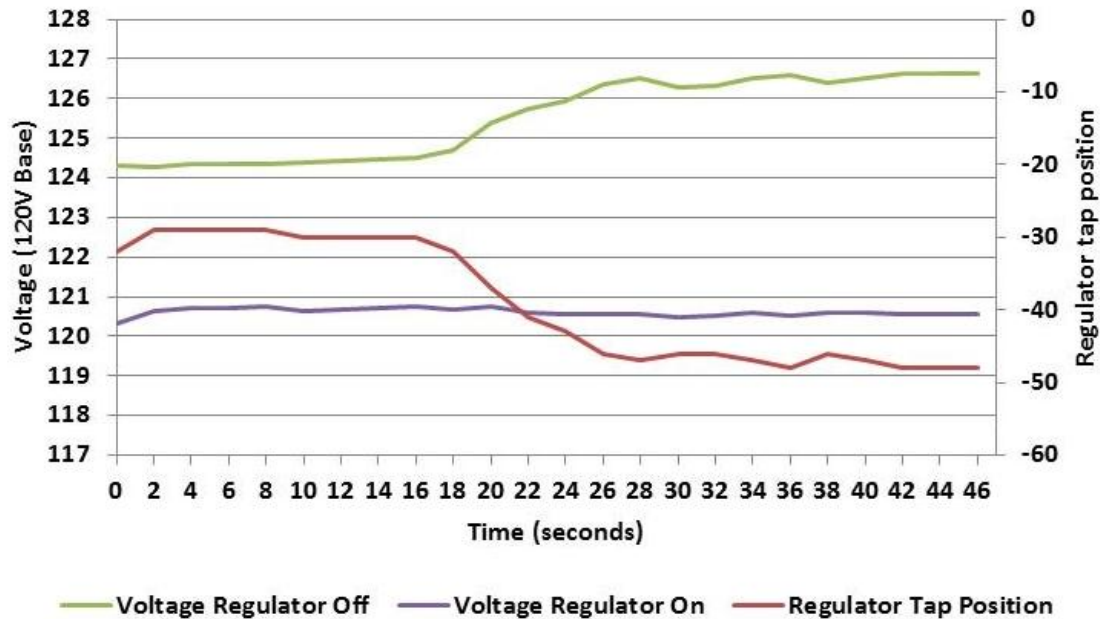

Figure 5.11. Voltage profiles and regulator tap position during simulation of PV output ramping.

The voltage is monitored at the section with the highest voltage in the base case, which is at the location of the 19.14 kW PV generator in the diagram in Figure 5.9. In Figure 5.11 above, the results for the base case without the regulator (green line), show the voltage on this section exceeding 126V after about 25 seconds. In the case with the regulator operating (purple line), the voltage is maintained between 120V and 121V. The regulator (red line) taps down to compensate for the increase in PV output. The time delay of the transformer LTC is not known, but is likely to be 30 seconds. If that is the case, the primary transformer LTC is likely to have one step down at some point in the analysis time frame in the case with the regulator off, but this would probably not occur before the voltage has exceeded 126 V, so it would not prevent the voltage violation from occurring.

It should be noted that the regulator voltage set point is set at an arbitrary value of 123V for this study. It could be set higher or lower depending on the desired voltage at the customer location.

Next steps include evaluating the results at multiple locations by aggregating benefits at the system level using equivalence, 3-phase models. Enhancements are being investigated and will be further developed as part of the demonstration pilot being conducted by Hawaiian Electric Company and Gridco.

#### 5.3.4 Conclusions & Recommendations

The results show a case where there is a large increase in PV output over a short space of time, resulting in a potential high voltage violation on the customer circuit. The voltage in the case with the regulator turned off is compared against that with the regulator turned on for the full analysis period, and it can be seen that the high voltage violation is avoided with the inclusion of the regulator, provided that the regulator does not reach the limits of its voltage adjustment range.

The analysis presented in this report represents a simple quasi-dynamic study of the regulator on a distribution feeder with generic properties. While this is useful when examining the effects of a regulator on customer voltage, it is recommended that a more detailed study be carried out to investigate the performance of the regulator and its effect on inverter operation in a transient/dynamic study.

#### 5.4 Using Proactive Models to Strategically Site & Inform Demonstrations

Strategic partnerships with industry have been established to evaluate other emerging mitigation technologies. Through the Hawaii Energy Excelerator [12] program, Hawaiian Electric Company will be actively engaged in technology demonstrate pilots for new customer engagement and distributed storage technologies. Table 5.2 provides as brief description of the technologies and pilot objectives in the next year to address current needs.

Table 5.2. Examples of New Technology Pilots to Inform Mitigation Needs.

Partner: New Capability	Objective & Benefits
GridCo: Enable cost-effective, dynamic volt/VAR control at the distribution level	<p><b>Objective:</b> Instrument 2-3 highly impacted feeders to demonstrate dynamic volt/VAR control at distribution transformers</p> <p><b>Benefits:</b></p> <ul style="list-style-type: none"> <li>- More effectively manage voltage issues closer to the PV impact areas.</li> <li>- Investigate new capability that enables better utility visibility to mitigate PV impact at the local level for improved response and management of overvoltage conditions.</li> </ul>
STEM: Enable real-time storage response at the distribution level for grid support services	<p><b>Objective:</b> Deploy 1MW of customer-sited, distributed storage that can provide real-time response to manage load and PV variability</p> <p><b>Benefits:</b></p> <ul style="list-style-type: none"> <li>- Facilitate strategically sited, distributed storage that mutually offers customer saving and grid support services</li> <li>- Investigate aggregator capability to use storage to minimize PV backfeed with real-time customer load capability</li> </ul>
PeoplePower & IBIS: Enable access and assessment of high-resolution meter data to improve customer utilization and grid status/reliability monitoring	<p><b>Objective:</b> Utility internal pilot with 70 employees to gather and assess high-resolution meter data for improved customer engagement, load management and value-added grid reliability monitoring</p> <p><b>Benefits:</b></p> <ul style="list-style-type: none"> <li>- Evaluate support services and communication logistics to access, manage and backhaul “big data”</li> <li>- Engage end users in developing web-interface and data portals that provide transparent utility data responsive to customer’s needs for cost-savings and usage by circuit type.</li> </ul>

These pilots will provide new device models and performance information necessary to evaluate responsiveness controls and new operating conditions to cost-effectively shape future grid modernization investments. Through partnerships with “like-minded” vendors and by coupling proactive modeling techniques and field verification pilots of new technologies that offer more utility visibility, control, and distributed response for reliability, cost-effective mitigating solutions can be consistently assessed and confidently fast tracked into operations. The modeling enhancements and demonstration pilots being pursued are aligned with Hawaiian Electric Companies’ strategic objectives for renewable integration and grid modernization.

## 6.0 SUMMARY & RECOMMENDATIONS

The Proactive Modeling methodology was initially developed to study high penetrations of PV on Oahu distribution circuits already experiencing high PV growth. The objectives of this effort were to apply the Proactive Modeling methodology and demonstrate how the approach can be used to consistently and transparently be used to determine high penetration PV impacts on the feeder and the system. The effort defines a new process for proactively monitoring, modeling and tracking the changes on the distribution infrastructure. Given the information, interconnection of PV systems can potentially be streamlined using a cluster analysis approach. Results identify system constraints, help quantify impacts and provide infrastructure upgrade options to accommodate current and future growth of distributed PV.

### 6.1 FEEDER RESULTS AND STREAMLINING BENEFITS

From the initial study, the methodology was developed and improved upon through lessons learned. With the successes and shortfalls of past analyses, the methodology was updated as needed and has developed into its current state, providing a well-defined process and guidelines to conduct high penetration PV studies and report results in a consistent and efficient manner.

In this way, the three Electrical Clusters of this study were analyzed using the Proactive Modeling methodology and have realized the benefits of a standardized routine for analysis and reporting. Study phases for each of the three Electrical Clusters were completed within 2 weeks given the “plug-and-play” nature of the data validation, prioritization and reporting process. Expanded analysis results and mitigation solutions can also be implemented for a variety of conditions.

In summary, electrical clusters on the island of Oahu were assessed using the Proactive Methodology with the aim to find limitations on the distribution circuits, validation processes were performed for the transformers, and finally the effects on the system were identified at existing PV penetration levels and future scenario levels.

#### Cluster A

- At the time of the analysis, the simulation results show that one out of nine circuits in Cluster A has existing PV penetration levels already in excess of the backfeed limit, which suggests that it may already be experiencing reverse power flow or backfeeding. Distribution feeders, transmission lines carrying electricity to a distribution point, are traditionally not designed to carry bidirectional power flow; therefore a number of issues can be occurring when distributed generation causes reverse power flow as this condition occurs when PV generation exceeds the demand (including losses) on the feeder. Additional protective monitoring devices may be recommended for this area.

#### Cluster B

- Simulation results show that two out of nine circuits in Cluster B have existing PV penetration levels in excess of the 5% fault current rise limit. Fault current occurs when too much current flows through the electrical power grid in an uncontrolled manner. This event causes short-circuits, which result in a rapid increase in the electricity drawn from power sources within the grid. This condition if unchecked can lead to cascading or rolling blackouts. If the fault current is higher than the capacity of the protective devices on the system, this can lead to these devices not performing properly and not protecting the distribution circuit which can impact everyone on the circuit. Another identified issue on

this particular cluster is the condition of excessive backfeed. Additional monitoring is recommended along with more frequent assessments. Mitigation strategies will need to consider system impacts which require more than standard interconnection models as described in this analysis.

#### Cluster C

- At the time of the analysis and with existing levels of distributed PV, the simulation results show that these circuits are within the backfeed limit, which suggests that they are unlikely to experience reverse power flow. However, with the queued PV penetrations on the system accounted for in the simulations, and if all of this queued PV on the distribution circuits is implemented, backfeed limits will be exceeded. Given this understanding, additional upgrades including protective devices can already be considered to look at resolving or limiting the PV on certain feeders, installing bi-directional monitoring on protective devices and also requiring additional controls at the distributed PV level depending on the type of projects (e.g. NEM, FIT, SIA)

Based on this set of steady-state results and preliminary dynamic analysis, the Proactive Modeling methodology has demonstrated capability to provide valuable insight to distribution level and system constraints given different scenarios of PV penetration (existing and future potential). Results demonstrate the importance of integrating distribution impact analysis on system performance, especially at high penetration levels. Aggregated PV response and output levels at high penetration may have far reaching impacts on traditional system planning considerations, such as on long range generation planning, on combination of units dispatched and on scheduling of utility generators for maintenance. These traditional system planning considerations will also need to account for a new type of distributed generator on the system. New parameters governing variable PV output and aggregated performance need be captured through new industry policy and requirements and factored in to realistically plan grid reliability and contingencies for the future. Using a more proactive, simulation-based modeling process connecting impacts of DG with system models provides the utility valuable information and capability to look-ahead on critical conditions that may impact reliability and safety and thus inform follow-on decisions or action. Proactive assessments provide continuous tracking and monitoring of critical feeders in a systematic and transparent fashion. The methodology also links distribution and transmission level impacts to inform more robust and cost-effective mitigation measures, even ahead of concerns. The ability to proactively plan ahead enables integration of more viable and appropriate renewable technologies and grid modernization needs.

## 6.2 NEXT STEPS

This report captures the Proactive Process and results from 3 diverse electrical clusters on the island of Oahu covering over 20 distribution feeders. Each feeder now has a percentage level where a condition or threshold of exceedance has been determined using a Grid Impact Factor (GIF) for the interconnected transformers. Positive GIF values show the Cluster has low impact on the grid and negative GIF values indicate mitigations are needed. Efforts in this analysis demonstrate the applicability of the Proactive process to prioritize, validate and consistently conduct model evaluations and assess mitigation strategies. As such what use to take 6-9 months of building models and validating data can be completed in a 2-3wk cycle. This enables more frequent and routing monitoring of the impacts. The goal is to complete assessment on the island of Oahu following the same methodology.

The approach also enables utilities to conduct scenario-based analysis using enhanced distribution and transmission models in steady state and dynamic modes to proactively assess demand for PV on the feeder as part of routine planning. By modeling and identifying feeder thresholds using a range of increasing penetration levels of DG on a feeder coupled with the ability to aggregate impacts up to system levels via cluster models, existing utility modeling tools can be proactively used to study, identify and capture impacts of distributed PV. While this penetration levels were evaluate up through 135% of peak circuit values, this does not mean that the utilities can or have customer requests for PV installations up to those values at present. The range of PV penetrations used in the report was established to assess circuit thresholds and evaluate likely limits resulting from increase PV levels. As the process becomes implemented into planning and ongoing interconnection practice, the range will necessarily be more reflective of each utility and islands mix of resources, load and equipment.

The ability to preview and be more aware of where “hotspots” can occur has significant benefits in helping to inform mitigation strategies and interconnection studies, a priori. These simulation-based analysis and results can also be used to identify potential issues across the system versus just at one location and support investigations to more routinely prioritize upgrades and formulate mitigations and develop more accurate costs factors applicable across multiple projects and across the system.

The Proactive Approach Methodology transcends distribution and transmission modeling by representing and aggregating impacts modeled at the distribution level as equivalent, balanced generation at the transmission level. Applying this aggregation approach, dynamic modeling analysis using PSS/E to evaluate PV variability and ramp impacts on the system and to assess mitigation technologies based on the results from clusters were further evaluated. Based on the clusters evaluated, “hotspots” and specific issues were identified and visually rendered to illustrate the value of modeling results to communicated emerging issues and help prioritize action. These enhanced models were also used to systematically review conditions, evaluate mitigating technologies, such as for overload and backfeed conditions, and quantify effectiveness and cost-benefit for application of similar solutions at other locations on the grid exhibiting similar conditions.

Application of models and results using mitigations options, including evaluation of new technologies, are provided and documented in the series of three reports conducted under this project. Recommendations are to continue to assess the remaining clusters on Oahu and evaluate high penetration priorities and solutions applicable to the majority of clusters and feeders on Oahu, as well as on other islands. Upon completion, this 5 month effort will have documented and demonstrated a consistent methodology for conducting proactive studies on high penetration PV feeders, developed a robust mitigation options list and captured recommendations to help prioritize strategic solutions based on simulation-based analysis and cost-basis to proactively plan grid modernization needs. Efforts layout a pathway to systematically baseline current conditions so as penetration levels continue to increase, there is consistency and transparency on how impacts are tracked, at what level they become very costly and when system reliability and cost impacts outweigh benefits of further interconnections. Ability to systematically establish baselines will provide realistic targets as well as provide a measure of the effectiveness of new technology solutions and cost-benefits of accommodating more distributed generation. Most importantly, the simulation-based approach provides awareness to proactively address concerns and evaluate new technologies without risking utility personnel safety, public safety and system reliability.



Recommended utility actions include:

- Continue and complete additional clusters studies using the Proactive Modeling process for the island of Oahu;
- Integrate results and lessons learned from the Proactive Process into transmission and distribution planning's model maintenance practices;
- Develop a list of mitigation criteria based on issues observed and modeled issues including prioritization of circuit monitoring needs to complete validation;
- Use integrated models to assess the effectiveness and reliability of new technologies and mitigation options to conduct cost benefit analysis to inform investments;
- Link timing of evaluations and re-evaluations of feeders to current resource procurement tariffs and interconnections on the feeders to reflect current conditions and levels of penetration;
- Apply, assess and recommend implementation of mitigation measures per analysis, as appropriate.

## 7.0 REFERENCES

- [1] Hawaiian Electric Company, "Cluster Evaluation Methodology", Hawaii Grid Cluster Evaluation Project Task 2.1 Report, DBEDT, Jan 2014.
- [2] Hawaiian Electric Company, "Circuit Evaluation and Selection", Hawaii Grid Cluster Evaluation Project Task 2.2 Report, DBEDT, July 2014.
- [3] DNV GL SynerGEE Model Website:  
[http://www.gl-group.com/en/powergeneration/SynerGEE\\_Electric.php](http://www.gl-group.com/en/powergeneration/SynerGEE_Electric.php)
- [4] Siemens PSS/E Model Website: <http://w3.siemens.com/smartgrid/global/en/products-systems-solutions/software-solutions/planning-data-management-software/planning-simulation/pages/pss-e.aspx>
- [5] Zack, J. "Renewable Energy Forecast at Hawaiian Electric Company," Asia Pacific Clean Energy Conference, September 2013,  
<http://www.ctsi.org/events/APCE2013/program/pdf/John%20Zack.pdf>
- [6] Nakafuji, D., Dangelmaier, L., and Reynolds, C., Hawaii Utility Initiatives to Enable Wind (WindHUI)", Final Technical Report, DOE/EE0001379,  
<http://www.osti.gov/scitech/servlets/purl/1049311>
- [7] Orwig, K. et al, "Recent Trends in Variable Generation Forecasting and Its Value to the Power System," IEEE Journal Paper, 2013 (submitted).
- [8] Greentechmedia, "Sunshot Launches \$60 Million in DOE Money to Improve Solar," October 2013, <http://www.greentechmedia.com/articles/read/SunShot-Launches-60-Million-in-DOE-Money-To-Improve-Solar>
- [9] High Penetration PV Initiative (HiP-PV), California Public Utility Commission California Solar Initiative website: <http://calsolarresearch.ca.gov/funded-projects/66-high-penetration-pv-initiative>
- [10] Nakafuji, D. et al, "Visualization of High Penetration PV," HiP-PV Project Report, CPUC CSI Consultant Report, July 2013,  
[http://calsolarresearch.ca.gov/images/stories/documents/Sol1\\_funded\\_proj\\_docs/SMUD/SMUD-HECO\\_Task-4\\_PilotVisual\\_FinalRpt\\_2013.pdf](http://calsolarresearch.ca.gov/images/stories/documents/Sol1_funded_proj_docs/SMUD/SMUD-HECO_Task-4_PilotVisual_FinalRpt_2013.pdf)
- [11] GridCo technology website, [www.gridcosystems.com/](http://www.gridcosystems.com/)
- [12] Hawaii Energy Excelerator website, [www.energyexcelerator.com/](http://www.energyexcelerator.com/)

# Hawaii Grid Cluster Evaluation Final Report

Proactive Approach for High Penetration PV  
Cluster/Circuit Analysis & Mitigation Assessment  
Summary Project Report

**HAWAIIAN ELECTRIC COMPANY**

June 2014



Hawaiian Electric  
Maui Electric  
Hawai'i Electric Light

**Proactive Approach for High Penetration PV  
Cluster/Circuit Analysis & Mitigation Assessment  
Final Consolidated Project Report**

**Submitted to the  
Hawaii State Energy Office  
Hawaii Department of Business, Economic Development, and Tourism**

**by**

*Contributing Authors*

Hawaiian Electric Company:  
Dora Nakafuji  
Amra Brightbill

DNV:  
Jonathan Flinn,  
Ronald Davis

**June 2014**

### **Disclaimer**

This report was prepared as an account of work sponsored by an agency of the United States Government. Neither the United States nor any agency thereof, nor any of their employees, makes any warranty, express or implied, or assumes any legal liability or responsibility for the accuracy, completeness, or usefulness of any information, apparatus, product, or process disclosed, or represents that its use would not infringe privately owned rights. Reference herein to any specific commercial product, process, or service by trade name, trademark, manufacturer, or otherwise does not necessarily constitute or imply its endorsement, recommendation, or favoring by the United States Government or any agency thereof. The views and opinions of authors expressed herein do not necessarily state or reflect those of the United States Government or any agency thereof.

### **Acknowledgements**

This material is based upon work supported by the Department of Energy and the State of Hawaii Department of Business, Economic Development, and Tourism under award number DE-EE0005354/0005. Efforts build on methodology utility proprietary models and work developed in collaboration with western utility partners under prior grant award from the California Public Utilities Commission's California Solar Initiative (CSI). No utility customer, grid data or business sensitive information is released under this work and all information pertaining to the utilities and proprietary software remain the possession of the utilities.

**TABLE OF CONTENTS**

**EXECUTIVE SUMMARY .....4**  
**1.0 INTRODUCTION ..... ERROR! BOOKMARK NOT DEFINED.**  
**7.0 APPENDICES .....25**

## EXECUTIVE SUMMARY

Imagine a capability within the utility to rapidly screen and interconnect groups of DG resources and proactively assess and mitigate transmission and distribution impacts due to high penetrations of distributed PV. A new, proactive modeling method for assessing the high growth and penetration of distributed generation (DG) on distribution and transmission systems has been developed as part of a collaborative effort between Hawaiian Electric Companies (Company), the Sacramento Municipal Utility District (SMUD) and Det Norske Veritas (DNV) with funding from the California Public Utilities Commission, California Solar Initiative (CSI) initiative. Through funding by the State of Hawaii Department of Business, Economic Development and Tourism, the proactive approach is applied and documented for three electrical clusters on Oahu to illustrate 1) how the methodology can be used by other utilities to systematically assess and baseline impacts of high penetration of PV resources on the distribution level and 2) how distribution level impacts can be consistently “rolled-up” and accounted for in transmission level and load flow analysis for the system. Three Oahu electric clusters, with distinct load types and varying circuit characteristics, were used to illustrate how the enhanced proactive modeling tools and validation data can be used to keep an eye on growth, identify grid impact issues and suggest mitigating options, a priori. Benefits captured include enhanced models to expedite modeling processes, validated tools and priority for monitoring, mitigation strategies supported by cost-benefit analysis, training to retool and engage workforce and capability to streamline the interconnection process.

### Background

At close to 100% PV penetration levels on circuit peak for many of the distribution feeders, the Hawaiian utilities needed a new approach for modeling and evaluating projects for connection on to the grid. Traditional rules of thumb, standards and existing settings were quickly being compromised as more PV systems were observed on the 12 kV level. Without the ability to see and manage PV contributions to the grid and prioritize studies, the backlog of projects awaiting traditional one-off IRS studies became a drain on utility distribution planning resources and a source of customer complaint.

This Proactive Approach was developed and introduced through utility and industry partnership as a new methodology specifically tailored to contend with high penetration PV analysis and conditions. The methodology leverages and integrates new modeling enhancements made to the transmission and distribution models to expedite analysis with PV that account for the impact of distributed PV by location and installed MW capacity. Unanimously agreed upon and encouraged by industry, including the Hawaii Public Utility Commission recent decision and order and the Reliability Standards Working Group (RSWG) PV Subgroup (<http://puc.hawaii.gov/wp-content/uploads/2013/04/RSWG-Facilitators-Report.pdf>), the Proactive Modeling Approach is being incorporated and evaluated by the utility planning departments to baseline existing grid conditions and to establish a forward looking process to account for the impact of DG resources for planning and operations.

For this project, three electrical clusters (Figure 1) comprised of electrically connected feeders were used to demonstrate the Proactive Approach and document the methodology. These circuits were chosen because of the high penetration of PV, availability of utility data on majority of the circuits in the cluster for validation purposes and also based on the diversity of the types of customer loads on these circuits.

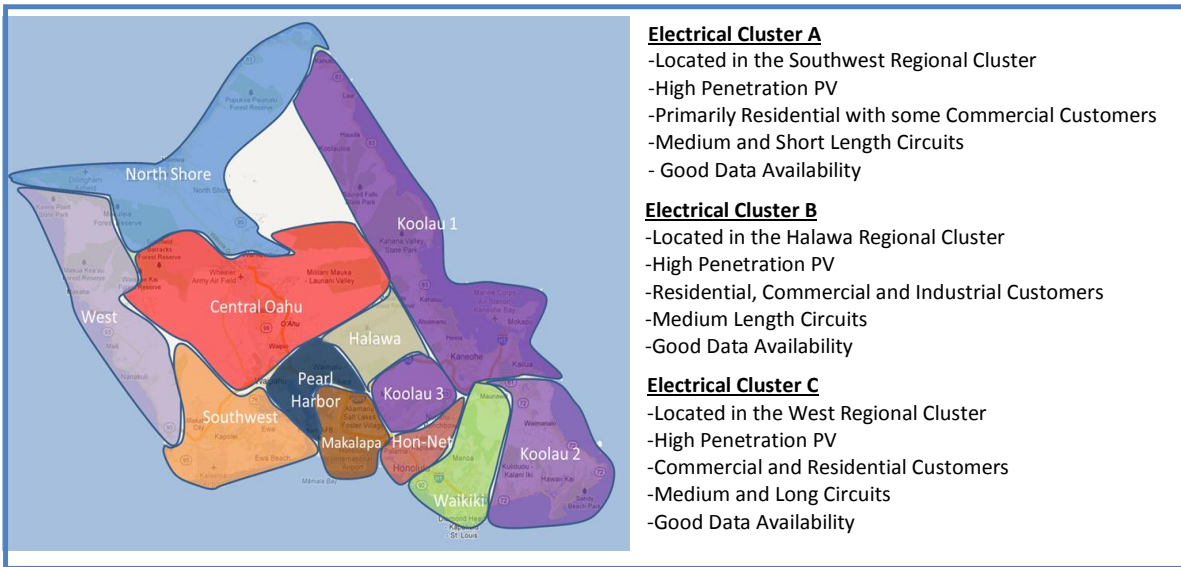

Figure 1. Three Electrical Clusters identified for evaluation studies.

New modeling tools, new terminology and prioritization process, new data and data validation techniques, new metrics to address high penetration PV conditions were introduced as part of the proactive methodology and documented in the reports. Results of the modeling, techniques and lessons learned from the Hawaii Proactive Approach are applicable to all utilities contending with challenges (planning, op rating & mitigating) of future high penetration issues related to DG.

This project summary report provides a high level overview of the Proactive Approach, the genesis and strategic goal. It also serves to unify the three different reports developed as part of this project. The experiences and benefits are captured in a series of three reports that describes the details of the methodology, modeling, validation, results and lessons learned. The reports provide additional details on evaluation criteria and applicable definitions and assumptions as applied on the island of Oahu. Similar methodology can be applied for other utilities and regions. The three reports include

- Report 1: Proactive Approach Methodology
- Report 2: Cluster Selection and Validation
- Report 3: Proactive Approach Modeling Results and Mitigations

### Proactive Modeling Process

To more accurately represent and capture the impact of aggregated DG on the utility infrastructure, the attributes and performance characteristics of DG technologies must be accounted for and represented in standard utility vetted transmission and distribution models. By factoring inverter-based technologies and solar resource (irradiance) information into the models, distributed attributes relevant for capturing regional smoothing effects and cloud impacts of DG resources can be assessed. Figure 2, provides an illustration on how the new layers of information can be overlaid to assess grid conditions and comprehensively be applied to evaluate mitigation solutions for specific conditions and for common systemic issues.



The Proactive Approach does not replace traditional IRS studies which still need to be performed for specific projects, but the approach provides a systematic way to assess penetration impact levels through simulation-based models which can be useful in identifying problematic areas or “hotspots” or regional behavior across the system, a priori, resulting from solar variability and high penetrations. This ability can be looked at as providing a forward-looking, preventative maintenance plan for the distribution and transmission infrastructure.

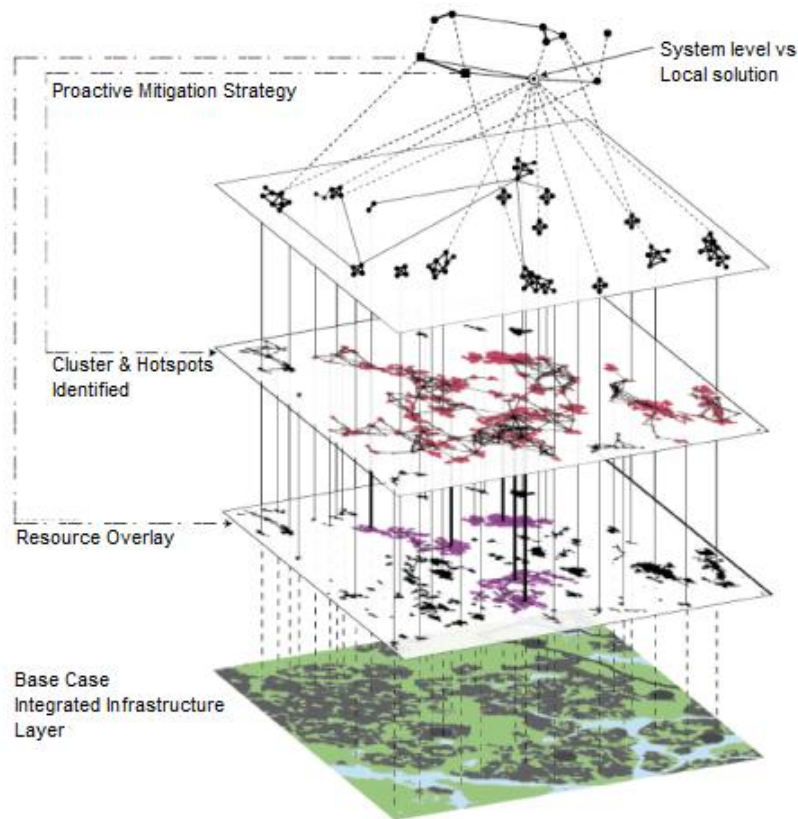

Figure 2. Graphical Representation of the Proactive Modeling Approach.

The objectives of the Proactive Studies include:

- Applying the cluster-based model organization and new variable resource data requirements for conducting high penetration analysis on distribution and transmission systems
- Identifying levels of PV penetration at which specific problems begin to occur for the distribution system;
- Using simulations to quantify remaining capacity in kW on existing distribution infrastructure and provide perspective on the potential of additional PV installations;
- Informing system impacts due to distributed PV through both steady-state and dynamic modeling analysis; and
- Evaluating and recommending mitigation options based on model evaluations.

This strategic approach for enabling a new, more comprehensive process for industry had some major technical challenges to overcome in the areas of modeling, resource and feeder data and Hawaiian Electric Company

distribution planning process change. Working with SMUD staff, DNV Kema modeling staff and AWS Truepower resource forecasting staff, a new process for prioritization and organizing 400 plus distribution feeders based on availability of data was developed by Hawaiian Electric. Modeling training was also conducted using the new tools to support adoption of new capability and confidence building to gain traction. While the change process is still in progress, the proactive process as documented in these reports, demonstrate a viable and consistent pathway for renewable integration and grid modernization needs.

To support the level of change resulting from high penetrations of distributed resources on the grid required development of the following capabilities:

- Enhanced modeling tools,
- Consistent screening and evaluation procedures,
- Common queue to prioritize studies, and
- Analysis capability to factor in new resource information and handle the increased volume of customer demand in a timely basis.

Major enabling milestones leveraged as part of this work include the following enhancements:

- Modeling Tools: Enhancing Transmission and Distribution (T&D) Models used by utilities to consistently account for distributed PV as a generator and not simply negative load. Models now can directly extract PV systems by location from the GIS and more accurately represent the feeders equipment attributes using a consistent SynerGEE model. Models are also being enhanced to capture details of new smart inverters as they are made available by the manufacturers.
- Monitoring & Analysis Tools: Gain visibility to behind-the-meter PV through monitoring and resource tracking and to prioritize impacts based on penetration levels. Leveraging grant funding, the Company has also been developing and sharing information from data tracking and analysis tools such as the LVM, REWatch and DGCentral to provide more public transparency on increasing PV penetrations, change impacts and development queues. Industry and renewable forecasting data also helping to better manage changing resource and production levels in real-time.
- Procedures & Techniques: Integrate and implement scenario-based techniques and new tools into the existing planning and operating practices to confidently and securely accommodate change. Training is being coordinated and tailored on the new modeling tools, techniques and validation datasets to support T&D interconnection and operational needs.

### ***Modeling Enhancements***

This effort supported application and demonstration of a comprehensive Proactive Modeling approach to conduct reliable, cluster-level (regional) and distribution circuit based analysis (local) that can help streamline DG assessment and proactively review high penetration DG impacts on the system. Specifically, the analysis focused on customer sited, rooftop PV systems on Oahu and some commercial PV systems connected to the electrical grid at the 12kV distribution level. Several enhancements were made to support modeling of high penetration PV.

First, traditional models were enhanced to include DG systems as generating resources versus traditional negative load which simply decreased the amount of load used by the customer. Shown Hawaiian Electric Company

in Figure 3, the PV system can now be modeled as a distinct generator within the distribution models. As DG resources have a distinct generating profile that follows the solar resource, the variability impacts and inverter performance attributes had to be properly accounted for.

Second, traditional single-line view of the circuits were converted to geographical views that could be rendered in the SynerGEE distribution model for all distribution feeders on the island of Oahu. The models need specific line segment length information and physical routes to more accurately model the distribution feeder performance. For solar resources, this physical location has a significant impact on how the installation produces electricity and how the installation impacts the circuit. Figure 4 compares a traditional single-line view of the circuits to a geographical view.

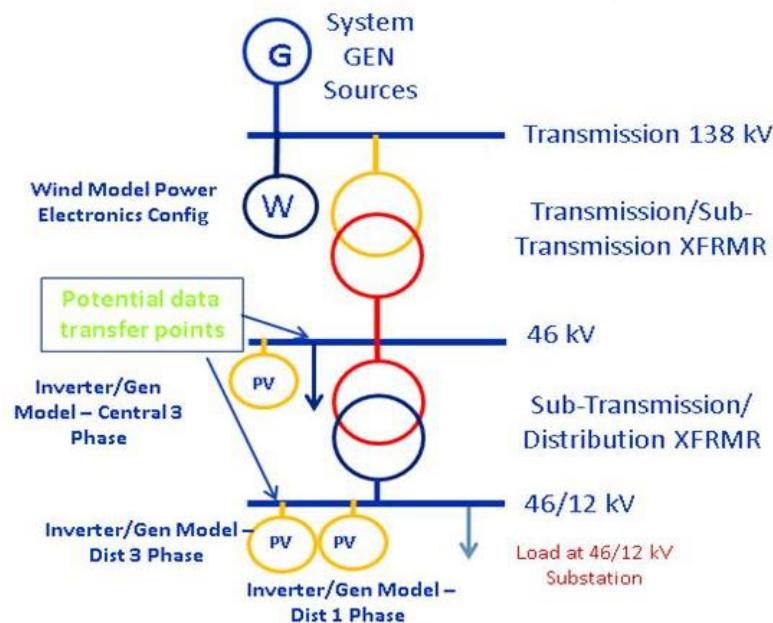

Figure 3. Modeling representation of equivalent load and aggregated distributed generation for transmission level analysis.

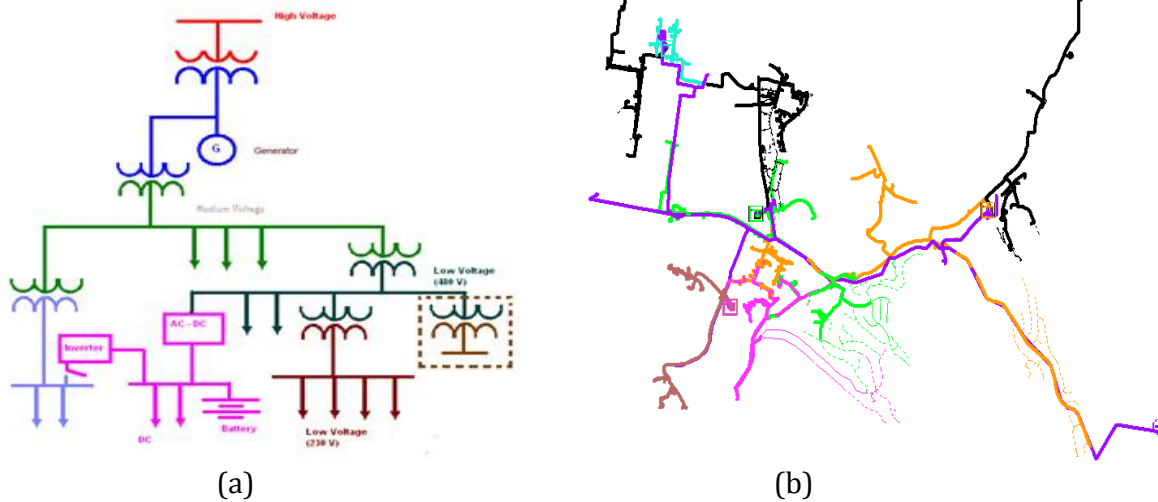

Figure 4 a) Typical single-line view compare to b) geographical view of distribution circuits.

### Model Organization and Terminology

As part of the modeling effort, the distribution circuits were grouped into 12 regional and electrical clusters to help systematically organize and streamline the analysis process. Definitions for the clusters are provided below and illustrated in Figures 4 through 5.

1. *A Distribution Circuit* is used to provide electricity to customers on various levels, including residential homes, commercial buildings and industrial parks, amongst other load types (Figure 5). On Oahu, the majority of PV installations are on the distribution circuit in the form of rooftop PV systems and ground mounted installations. A PV system may also be connected at the subtransmission level depending on the size and interconnection requirements.
2. *An Electrical Cluster* is defined as a subtransmission feeder, down to the distribution substations and the associated distribution circuits that are fed from these substations (Figure 6). Electrical Clusters are identified to study a single subtransmission feeder and all electrically connected distribution circuits to study the effects of PV on each distribution circuit as well as the aggregate effects on the subtransmission feeder to obtain a complete picture of the aggregated impacts. A subtransmission feeder provides a path to transmit electricity from the system level (138kV transmission line on Oahu) down to distribution level (distribution substations, distribution circuits 12kV and lower). For Oahu, the subtransmission feeders are rated at 46kV.
3. *Regional Clusters* are geographically organized areas grouping electrical clusters and may share similar terrain, solar availability and weather patterns. Twelve (12) Regional Clusters were identified for the island of Oahu. Creating Regional Clusters help to organize the electrical clusters and distribution circuits for analysis. See Figure 7 for an overview of the Regional Clusters on Oahu.

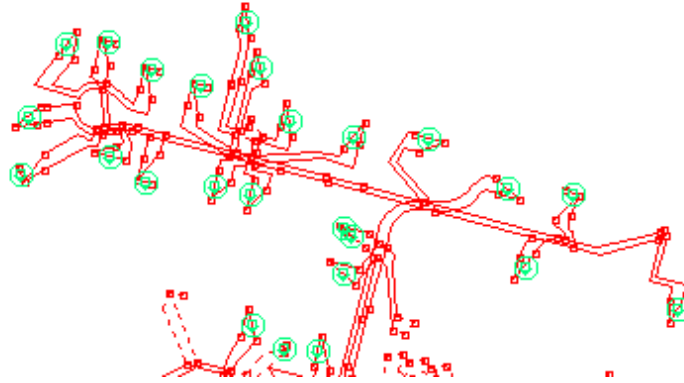

Figure 5. Detailed Feeder Model representation of a single distribution circuit and associated distributed roof-top PV systems shown in green.

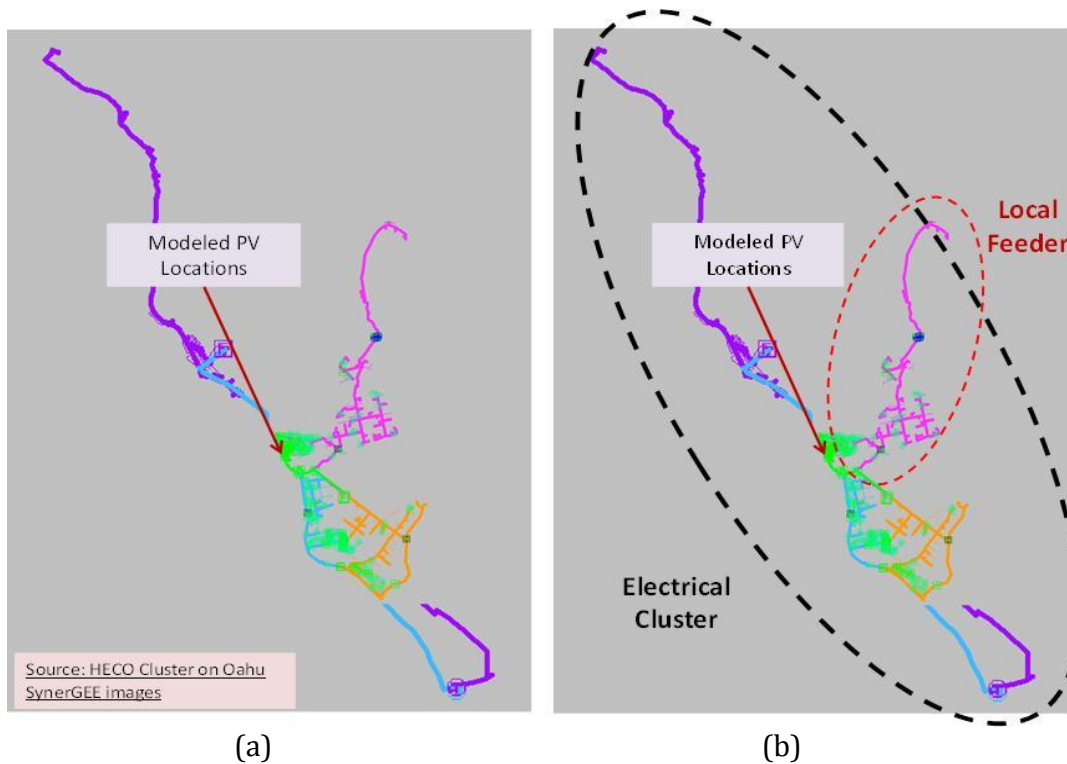

Figure 6. a) Geographical representation of distribution feeders, b) comparison of the distribution feeder (electrical lines circled in red) and electrical cluster (all lines circled in black).

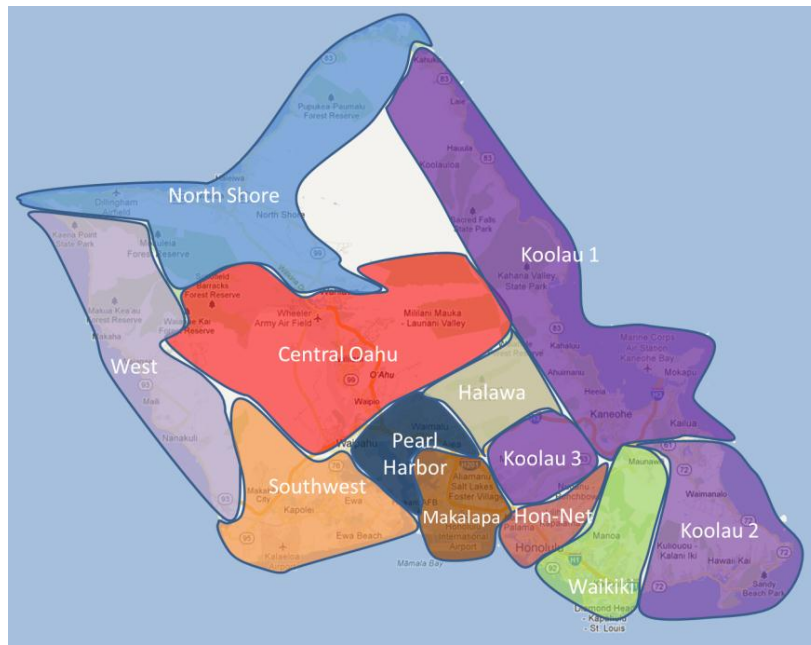

Figure 7. 12 Regional Clusters for Oahu.

**Evaluation Criteria**

The evaluation criteria (or Technical Criteria) described in this section are used to identify conditions or issues that impact the grid which may preclude additional PV penetration onto the circuits. Technical Criteria are defined based on a technical problem that would be caused on the electrical system with increasing levels of exceedance.

For steady-state analysis, Table 1 lists the Technical Criteria, associated limits and associated effects and impacts. Table 2 lists the Technical Criteria pertaining to dynamic modeling analysis conducted as part of this report.

Table 1. Technical Criteria for Steady-State Analysis.

Technical Criteria	Limit	Effects and Impacts
<b>Backfeed</b>	Reverse power flow as output of distributed generation exceeds feeder load	Existing distribution system equipment (such as transformers) have control systems that are set up to handle power flow in one direction only – from the transmission system through the distribution system to the customer. When power flow reverses at the transformer, the existing control systems may not recognize the change in direction and only sense the magnitude of the power. This can result in voltage regulation equipment moving in the wrong direction, causing increasing voltage problems.

<b>Load Tap Changer (LTC) Position</b>	Change in LTC position due to variation in PV output between 100% - clear day and 20% - cloudy day	The LTC is a voltage regulation device integrated into the transformer. In order to maintain the voltage on the distribution system within a specified band-width, it can increase or decrease the transformer voltage ratio incrementally when system load or generation conditions change. If the number of LTC position changes increases, this can cause a decrease in the service life of the equipment, and require more frequent maintenance or replacement.
<b>Thermal Loading</b>	Line loaded over 100% of specified capacity	If a line section is overloaded it can over-heat, causing potential damage to the equipment itself or surrounding structures.
<b>Voltage</b>	Voltage at any point on the distribution system is less than 95% or greater than 105% of nominal.	Customers would experience high or low voltage problems which can damage appliances and service may be lost if voltage remains outside nominal $\pm 5\%$ .
<b>Fault Current</b>	<p>Short circuit contribution ratio of all generators connected to the distribution system is greater than 10% (California Rule 21 and Hawaii Rule 14H criterion) or 5% (Hawaii internal criterion).</p> <p>The two criteria given trigger more detailed studies of protective equipment capacities. The 10% value comes from the Electric Rule No. 21 document, while the 5% value is a limit that has been communicated to DNV GL by HECO in previous projects, likely due to some of their distribution circuits being more sensitive to increases in fault current.</p>	Increases in fault current may require upgrading of protective equipment on the system. Circuit breakers at the sub-stations are rated for a maximum level of fault current, and if this value is exceeded the breakers may not function as required, causing damage to equipment and required replacement.

Table 2. Technical Criteria for Dynamic Analysis.

Technical Criteria	Limit	Effects and Impacts
--------------------	-------	---------------------

<b>Under Frequency Inverter Trip</b>	During an N-1 analysis, additional load shedding occurs compared to event occurring with no PV installed.	If PV inverters trip due to under-frequency during a transient event, this can lead to a cascading loss of generation, to which the electrical system responds by shedding load (blackouts) in order to balance the load with the reduced available generation.
<b>Over Voltage Inverter Trip</b>	During an N-1 analysis, additional load shedding occurs compared to event occurring with no PV installed.	As above, during a rapid reduction in generation due to inverters tripping, the voltage may increase, which again can be alleviated in the short term by the electrical system shedding load.

Technical Criteria define the adverse conditions that would result on the electrical system due to exceedance of the described limit and the resulting effects/impacts. For example, backfeed occurs when the output of distributed PV exceeds the customer demand or load on the circuit and may require upgrades to install bi-directional monitoring devices to detect power flow reversals and reviews of proper response from voltage regulating devices, if the backfeed situation cannot be mitigated in another way. Through simulation-based modeling of an increasing range of PV levels, the threshold of backfeed condition on circuits can be determined, a priori, so monitoring devices and assessments can be proactively performed.

### Data Validation

As there are over 50 Electrical Clusters across the island of Oahu, a Data Verification Process was introduced as part of the Proactive Methodology, as described in Task 2.1 and Task 2.2 reports, to prioritize the clusters for analysis based on the completeness of data (Figure 8). At minimum, an appropriate simulation model, measured customer load information (e.g., residential, commercial, industrial) on circuits and field monitored solar data local to the area, constitute “Good” data suitable for Electrical Cluster analysis. Areas that lacked one or many of the data are placed lower on the list and identified for further field monitoring and modeling at a later time when data is available.

Electrical Cluster (46kV)	Regional Cluster	Model Available	Load Data	Solar Data
Cluster A	Southwest	Yes	Good	Good
Cluster B	Halawa	Yes	Good	Good
Cluster C	West	Yes	Good	Good
Cluster D	North Shore	No	Good	Good
Cluster E	Makalapa	Yes	Good	Limited
Cluster F	Koolau 3	Yes	Good	Limited



Cluster G	Waikiki	Yes	Good	Limited
Cluster H	Pearl Harbor	Yes	Limited	Moderate
Cluster I	Koolau 1	Yes	Moderate	Good
Cluster J	Koolau 2	Yes	No Data	Good

Figure 8. Excerpt of Electrical Clusters List organized by data priority.

The three Electrical Clusters highlighted in this report demonstrate varying levels of “Good” data. They will be used to show how the Proactive Analysis can provide early detection of critical thresholds or impacts resulting from increasing penetrations of PV on the circuit, at the cluster level and even at the system level.

Figure 9 shows solar monitoring devices used by Hawaiian Electric to capture feeder load and solar irradiance data. Figure 10 shows an example of generation profiles from a single PV system used for modeling and validation needs.



Figure 9. Diverse field monitoring devices for measuring solar resource.

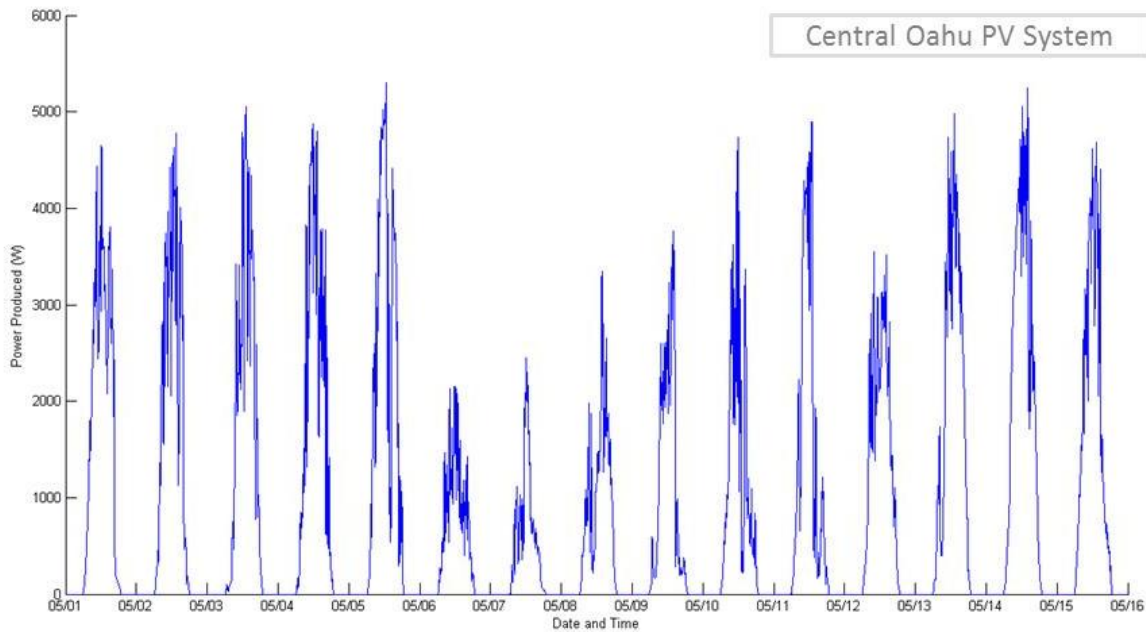

Figure 10. Solar PV system production profiles over a 2 week period.

With consistent data and models, the Proactive Approach can progressively build on prior studies as new data becomes available to assess impacts and consider mitigations to address emergent needs. Completed Cluster studies can thus be used to provide proxy information or be used to inform conditions on similar circuits that currently have limited or no data.

## Results

This report focuses on real-world application of the methodology with simulation results for three Electrical Clusters: Electrical Cluster A – the Southwest region, Electrical Cluster B – Halawa region, and Electrical Cluster C – the West region, as shown in Figure 1. Each Electrical Cluster is comprised of interconnected substations (46kV to 12kV level) and associated 12kV distribution circuits. Results presented highlight 3 out of 12 Geographic Regions on Oahu. These Electrical Clusters provide a good demonstration of the applicability of the Proactive Approach for different infrastructure conditions (i.e. types of customer loads, length of lines, data availability).

## PV Penetrations & Analysis Scenarios

For both the steady-state and dynamic analyses, scenarios are established and used to run the models. The scenarios are a means of capturing a variety of conditions of interest with varying degrees of sensitivity between the different conditions. The Proactive Approach Modeling methodology was developed to identify a list of scenarios that would capture all major conditions on the grid rather than developing a new custom list for each study. With automation introduced

into the modeling runs, covering an extensive list of conditions does not have a significant impact on the time it takes to complete the analysis.

The different scenarios for each of the steady-state parameters are shown in the Figure 11. Note, the analysis is carried out up to 135% of peak load as a modeling criteria and not necessarily indicating that 135% of peak load can be interconnected. This is an extreme level with the intention of creating an adverse issue and then backing down to identify at what penetration level begins to create the condition.

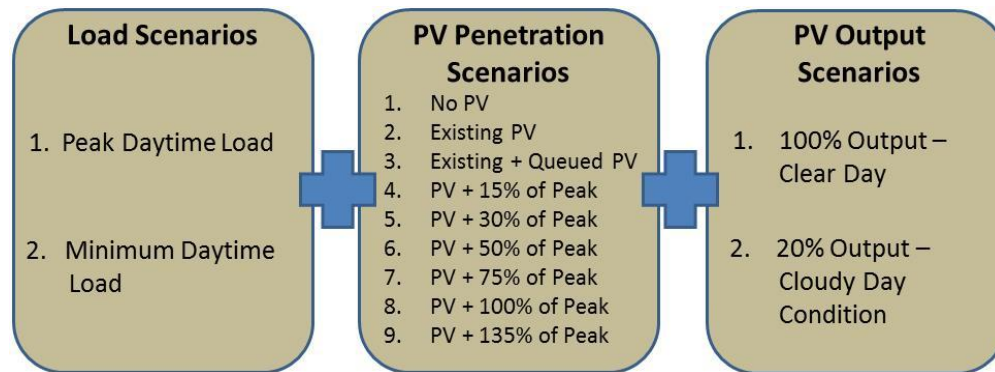

Figure 11. Scenario Combinations

For purposes of this study effort, the upper threshold was selected at a high level at 135%, meaning the solar penetration on that circuit is 135% of the circuit’s peak load (in addition to several intermediate levels) so that adverse conditions would be encountered and the maximum allowable threshold could be identified by backing down to intermediate levels. Fault current analyses are also run at each of the specified PV penetrations. During a short-circuit fault, the resistance of the section of the circuit where the fault occurs is reduced to near-zero, resulting in a massive increase in the current – this increased current is known as the fault current. Fault current analysis is used to calculate the magnitude or size of the available fault current. Installation of PV inverters typically increases the available fault current, and it is important for the protection systems (such as circuit breakers) to be rated to operate with the maximum available fault current on the circuit.

Table 3 provides a description of the compliance and exceedance levels for each of the Technical Criteria listed in Table 1. Descriptions further elaborate on the degree of severity and analysis treatment if the Technical Criteria is exceeded.

Table 3. Compliance with and Degree of Exceedance with Respect to the Technical Criteria.

Technical Criteria	Assessment of Degree of Exceedance of Technical Criteria
Backfeed	<ul style="list-style-type: none"> <li>The backfeed study is performed by identifying the minimum daytime load on the feeder. As it is assumed that the PV output could be at 100% at any time between 10am and 4pm, this minimum load represents the PV penetration at which reverse power flow may occur.</li> <li>Backfeed results are reported both at the feeder level and at the transformer level. On the Hawaiian Electric system, each distribution transformer may have from 1 to 3 distribution feeders connected, and there may be the situation where one of these feeders’</li> </ul>

	<p>experiences reverse power flow at the feeder head while the others do not. In this case there may still be voltage control issues on the feeder with reverse power flow, even though there is not reverse flow through the transformer, and as such it is important to be aware of when this condition may occur. The case where there is reverse power flow at the transformer is a more obvious problem as the voltage regulation systems must then be set up to recognize the direction of power flow and act accordingly.</p>
LTC Cycling	<ul style="list-style-type: none"> <li>In order to identify any LTC Cycling violations, for each load and PV penetration case the PV generator output is varied between 100% and 20%. For the same time-step (and therefore same customer load) the LTC position is compared for the two different PV outputs. As all other parameters remain the same, any change in LTC position can be attributed solely to the change in output of the PV generators connected to the circuit. If the LTC position changes, this constitutes a violation.</li> </ul>
Thermal Loading	<ul style="list-style-type: none"> <li>For each load flow analysis performed, the maximum continuous current on each feeder is calculated. Again, the first two cases are checked first to ensure that the customer load alone is not causing load violations. After these are verified, the maximum continuous loading on the feeders for all the other cases is calculated. If the continuous loading is above 100% on any section, this constitutes a violation. As with the voltage results, if a violation is found then the location and reason for the violation (if it is identifiable) is identified and presented.</li> </ul>
Steady-state Voltage	<ul style="list-style-type: none"> <li>For each load flow performed, the maximum and minimum voltage on each feeder is calculated. If these values are within the range 95% to 105% of the nominal voltage then there is no violation. If either the maximum or minimum voltage is outside this range, there is a violation. If the violation occurs in either case 1 or case 2 in Table 2.1.3 above (when there is no PV installed), then the model is checked to identify any inaccuracies as it is generally assumed that there should not be any voltage violations in an existing condition.</li> <li>If voltage violations occur outside of the first two cases, the location of the violation is identified and presented.</li> </ul>
Fault Current Rise	<ul style="list-style-type: none"> <li>The fault current rise study is performed by comparing the maximum fault current for each PV penetration scenario to the maximum fault current when no PV is installed. The results are important for protection systems coordination, and there are two criteria checked: 5% fault current rise (from no-PV condition) and 10% fault current rise (from no-PV condition).</li> </ul>

For high penetration PV, many of the traditional “rules-of-thumb” for compliance and exceedance levels may need to be reconsidered and will take time to evaluate. Planning studies such as these are being conducted by a number of utilities across the world and helping to inform standards development as the electrical grid transforms to accommodate a more diverse generation portfolio. Efforts are also currently underway by the Institute of Electrical and Electronic Engineers (IEEE), Federal Energy Regulatory Commission (FERC) and Underwriters Laboratory (UL) to revise standards that accommodate high levels of variable, distributed resources.

Hawaiian Electric Company

## Steady State Results

Results of the steady-state analysis for three Electrical Clusters on Oahu are described in the detailed reports. The three clusters are considered high penetration, have a diversity of customers (residential, commercial and industrial) and feature line lengths that range from short to long.

- Electrical Cluster A: Southwest Region , primarily residential, mix commercial
- Electrical Cluster B: Halawa Region, mixed residential, commercial and industrial
- Electrical Cluster C: West Region, primarily commercial, mix residential

Steady state analysis is used to evaluate how stable the system is due to slow and steady change conditions over the course of the day. For each of the clusters, a general description of the circuit, data availability and any missing data is provided and discussed. While not all circuits will have complete data, sufficient data is necessary to conduct validation checks and establish a confidence level for the conditions simulated and technical limits identified. Successful validation of basic parameters such as the demand and voltage provide a sense of confidence that the modeled results reflect reality. When validation parameters are outside validation range, there may be uncertainty in the model or the quality of the data which warrants further investigation. Through the Proactive Approach process, distribution feeders can be evaluated and validated. Results are also presented in a consistent fashion – graphical and tabular formats are presented for each cluster to facilitate analysis and also to compare results from one cluster to another. For each cluster, this report will provide the following:

- 1) Peak and minimum loading profiles for each feeder
- 2) Results of the validation and issues identified
- 3) Technical thresholds on feeders and existing PV levels
- 4) Summary of results

By example, Figure 12 shows the results for the seven distribution circuits in the Electrical Cluster B. The bar chart and tabular data representation provides a consistent template by which to show the results across the system so that results from one cluster study can be readily compared to another study.

The orange and blue dashed lines represent existing and queued PV levels consistent with Electrical Cluster A descriptions. Points of interest in the results include:

- On CB1 the queued PV penetration (blue dashed line) is above the limit for 5% Fault Current Rise;
- On CB2 the existing PV penetration (orange dashed line) is above the limit for 5% Fault Current Rise;
- On CB4 the existing PV penetration is significantly above the limit for 5% Fault Current Rise, and very close to or in excess of the limits for 10% Fault Current Rise and potential backfeed.

CB4 may already be seeing reverse power flow on some occasions at the head of the circuit, and therefore mitigation measures may be necessary in order to successfully add additional PV. For the feeders where the 5% or 10% rise in Fault Current criteria are exceeded (CB1, CB2 and CB4), additional checks on equipment are necessary to investigate whether the circuit breaker current ratings are exceeded. Inadequate fault current protection may lead to protection coordination issues on the circuit and can lead to equipment damage. The other circuits are not exhibiting these

concerns as the PV penetrations are currently well below the thresholds identified in the analysis (denoted with the limit range).

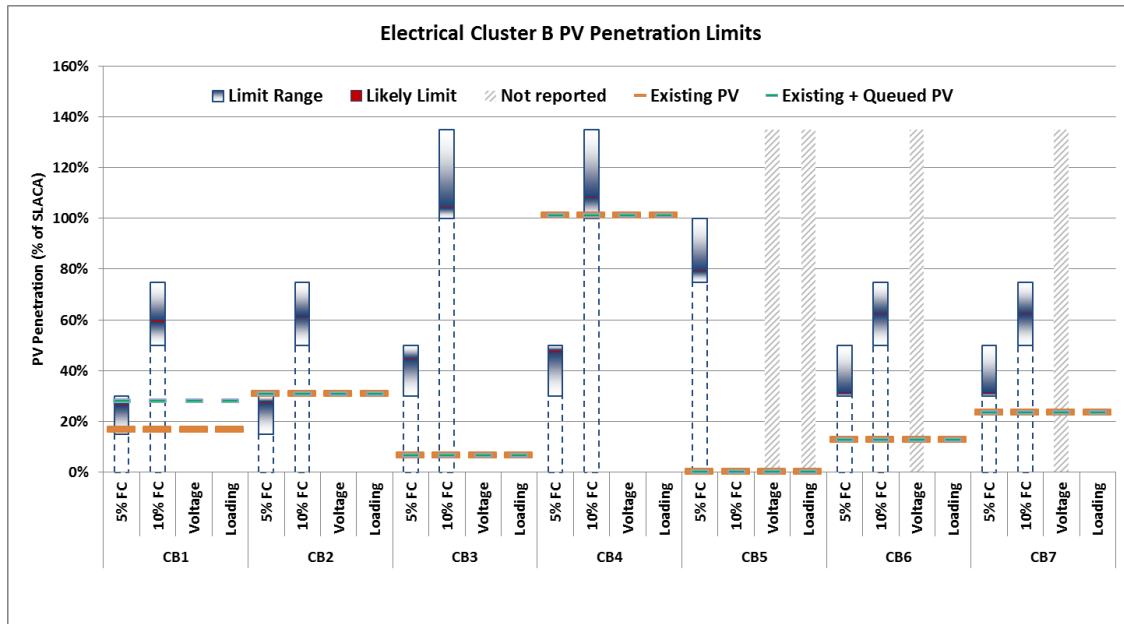

Figure 3.12. Electrical Cluster B Distribution Circuit Results.

Figure 13 summarize results at transformers of Electrical Cluster B. Based on results, existing PV penetration levels are well within the backfeed and LTC thresholds on the transformers. At present PV penetration levels, the transformers are not close to or exceeding the backfeed or LTC cycling limit. As penetration levels continue to increase for TB1 up toward 50% and TB2 up toward 30%, as identified by the lower end of the limit range bar, backfeed or LTC conditions need to be reviewed. TB3 and TB4 validation data was not completed and therefore not reported here, however once data is available to validate, similar analysis can be completed and immediately added to these results to track the changes on Cluster B.

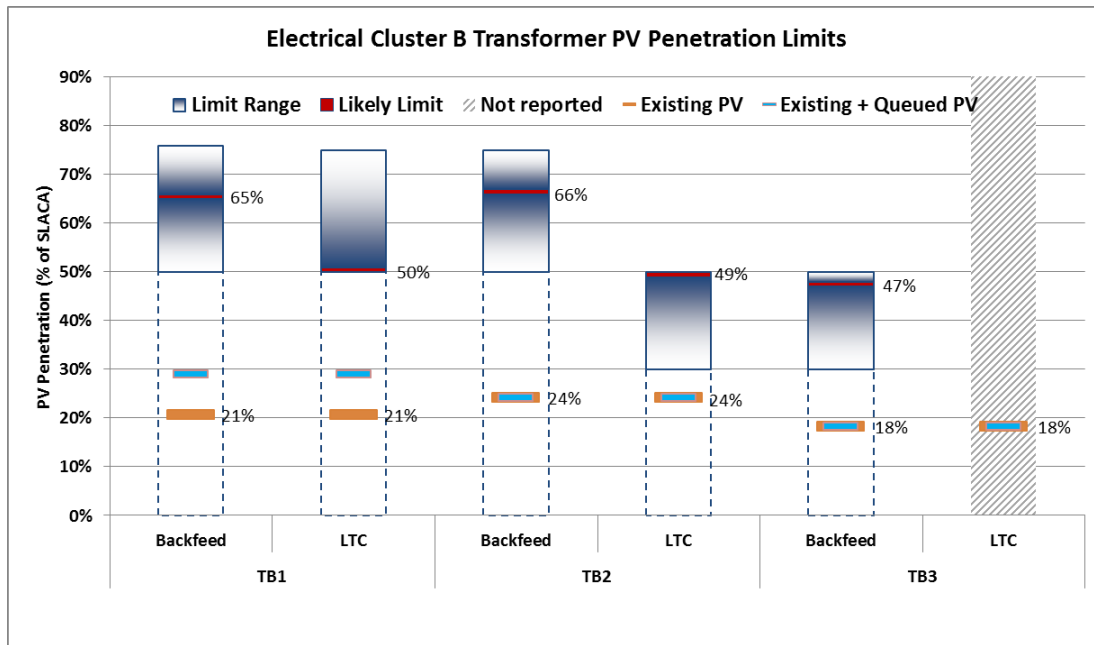

Figure 3.13. Electrical Cluster B Transformer Results.

### Dynamic Results

To account for the impact of distributed PV systems from the distribution level to the transmission system, the PSS/E model was utilized. The original utility transmission data set captured only the 138kV level down to the 46kV side of the 138/46kV transformers in the system, but did not include any of the actual 46kV sub-transmission lines or the 12kV distribution circuits that had the distributed PV generators. First the transmission model was modified to incorporate each Electrical Cluster at the 46kV level. The 46kV sub-transmission line was added to the relevant transformer, along with a 46/12kV transformer to represent each sub-station on the 46kV feeder (Figure 14). On the 12kV side of each of the 46/12kV transformers the existing generators are aggregated to a single generator, the future generators (used for the increased PV penetrations) are aggregated to a separate single generator, and the load is aggregated to a single load. In this way, the distributed PV generators were now represented and rolled up as an aggregated generator. Attributes of generation and inverter capabilities can now be simulated.

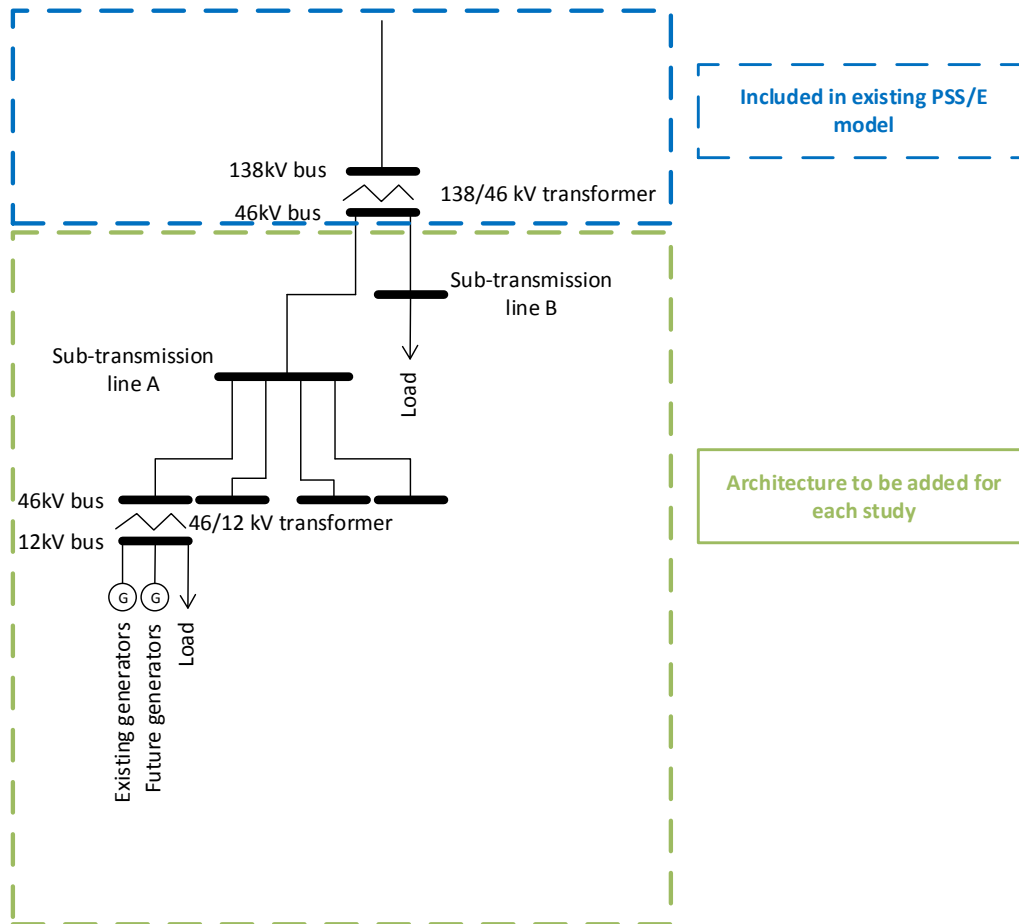

Figure 14. Dynamic Model Architecture includes Distribution Level representation in the Transmission Model.

Four analyses are performed, with the intention of capturing the extreme cases. These analyses are defined as follows:

1. Minimum load with no PV installed to establish a baseline reference.
2. Peak load with no PV installed also to establish a baseline.
3. Minimum load with PV equivalent to 135% of peak load.
4. Peak load with PV equivalent to 135% of peak load.

An example analysis has been performed in which two conventional generators are selected to be turned off in order to accommodate the addition of the PV generators. The results – shown in Figure 15 - show that in this new case the frequency drops below the lowest frequency found in the other two cases, which suggests that load shedding would be equal to and likely higher than the load shed in the case with no PV. This is only an example of how the assumptions affect the results of this analysis, and should not be used to determine what dispatch should actually occur.



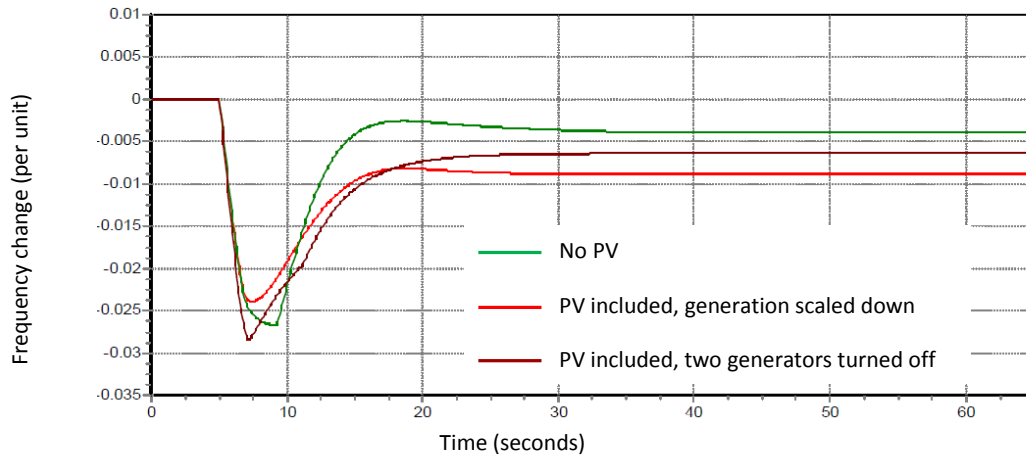

Figure 15. Frequency Results from Dynamic Analyses.

Based on this dynamic analysis, distributed generation does have an impact on system performance especially during contingencies such as the N-1 condition evaluated. Additional evaluation and careful consideration of the generator dispatch and contingency response of the system needs to be re-evaluated given high penetration PV impacts.

Additional transient analysis is planned however within the timeframe of this project, the goal was to capture the impact of distributed PV within transmission models and show they do have impact on results.

### Mitigation Strategies

The types and magnitude of mitigation measures are dependent on the circuit configuration, customer mix and PV penetration as the studies have shown. As proposed to be investigated using the Proactive Analysis, simulation based studies can be used to evaluate the most cost-effective measures, determine strategically which feeders to deploy and determine under what conditions (steady-state and transient) responses need to be. The feeder analysis work being conducted currently lays the framework for studying mitigation measures. Once the maximum thresholds for PV penetrations have been reached, these studies can also be used to assess expansion needs and evaluate broader mitigation measures as the grid modernizes and changes. New technologies that are appropriately modeled can then be simulated for their effectiveness without sacrificing the reliability and performance of the existing system.

A detailed table of options is provided in the reports however with each mitigation measure there are pros and cons. To fully assess the value of a new technology or mitigating measure, the cost-benefit of deployment needs to be addressed.

Hawaiian Electric Companies are proactively piloting new technologies that offer volt/VAR and dynamic storage capabilities and utilized the Proactive Models to conduct preliminary analysis of the cost-benefit of such technologies to address and help mitigate high penetration PV impacts.

The example described is a new integrated power regulator (IPR) that can be deployed at the utility distribution transformer. It acts like the distribution protective LTC at the substation but because it is located closer to customer loads and closer to the distributed PV system, the voltage/VAR control

at the local site can be more effective than at the substation level. Results shown in Figure 16 show that the GridCO IPR provides steady volt-VAR compensation and control at the local level. Continuing field verification is planned later in 2014 and through 2015 to demonstrate the value of such capability to effectively manage some of the overvoltage and undervoltage conditions throughout the island. Such solutions are cost effective as they have broad impact across the system and are integrated within existing infrastructure so there is no distributive technology change for field personnel.

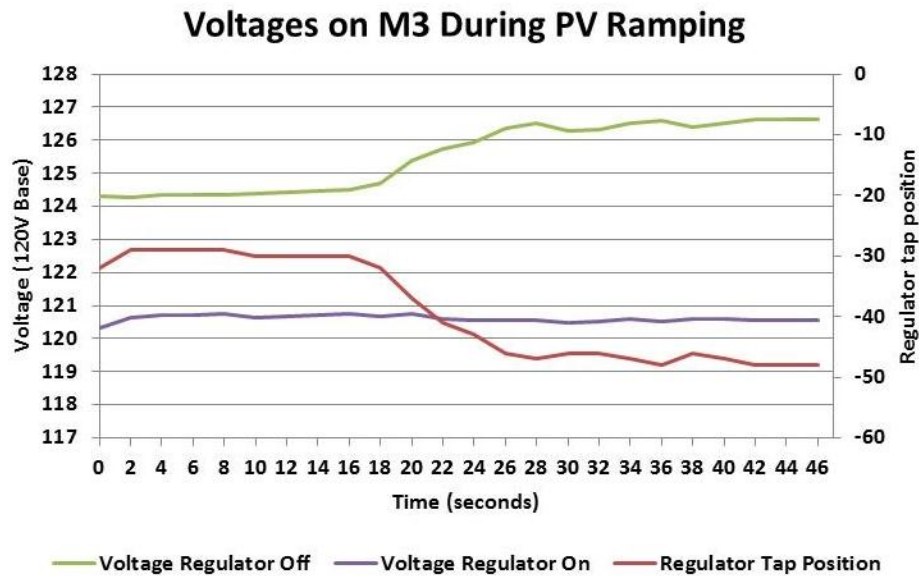

Figure 16. Voltage profiles and regulator tap position during simulation of PV output ramping.

## RECOMMENDATIONS AND CONTINUING ACTIVITIES

To adequately assess and stay ahead of high-PV penetration concerns on distribution feeders, the Proactive Approach has been developed to enhance planning models and incorporate inverter based information and distributed PV generators within the utility’s baseline modeling and planning practice. A prescribed model validation process has also been introduced and described in the project reports for this effort to streamline the data gathering, model build, model validation and reporting process in support of studies including Interconnection Reliability Study (IRS) needs.

This report documents the application of the Proactive Modeling process and showcases how simulations results can be used to track impacts and inform where monitoring and mitigation for high penetration PV is needed. Section 2.0 provides a detailed description of the overall approach in conducting the analysis and stepping through the analysis. High penetrations of distributed PV pose new requirements for traditional distribution modeling. As such, modeling enhancements, new data and analysis considerations are discussed including background on steady-state and dynamic analysis scenarios, description of the clustering approach to organize the grid, new data and validation requirements, technical criteria and assumptions and analysis process. These details are presented in a series of reports listed in the Appendix to give readers a glimpse into some of the considerations for running simulation models.

Model, data and prioritization of feeder impacts form fundamental components of the Proactive Approach to conduct cluster evaluations for groups of feeders instead of the traditional one project at a time or one feeder at a time analysis and to be able to consistently “roll-up” distribution level impacts up to the system level. One of the biggest changes to traditional modeling introduced as part of Proactive Approach is modeling distribution resources as generators versus negative load. This enables future smarter functionality to be incorporated to help manage variability due to renewables; however, it also helps improve system reliability and provides cost savings by accounting for behind the meter generation. Hawaiian Electric Companies have enabled also enabled a REWatch capability to “see” behind the meter generation, and with a proactive modeling capability, can begin to more timely and effectively “manage” the higher penetrations of variable behind the meter generation.

Recommendations for enabling the proactive capabilities include

- Organizational alignment and staff to support and maintain baseline model capabilities;
- Process coordination with resource procurement,
- Establish regular and timely system-wide reviews to update conditions
- Establish timeframe to conduct baseline planning studies and coordinate with industry
- Revised standards with guidance on procedures for modeling and data analysis;
- Support and prioritize ongoing grid and resource monitoring for modeling needs;
- Enhance modeling tools with device models to capture future “smart” capabilities;
- Maintain this capability through appropriate and consistent workforce training.

Maintaining updated baseline simulation models and routinely conducting analysis based on field data will enable utilities to track changes and assess mitigation strategies in a timely fashion across the overall electric system instead of one project or circuit at a time. Timely and regular review will ensure that baselines used by transmission and distribution planning adequately keep pace with system and local changes.

The modeling techniques and lessons learned from the Hawaii Proactive Approach are applicable to all utilities contending with challenges (planning, operating & mitigating) of future high penetration issues related to DG. As part of the review process for Proactive Approach, industry subject matter experts from utility and organizations like EPRI provided support for a new process that integrates simulation based modeling capability and data-driven analysis. Comments from other utilities and industry and the RSWG recommendations on Proactive Approach are captured in the Appendix.

As utilities, Hawaiian Electric Companies are one of the utilities contending with some of the highest levels of distributed PV penetration and are actively working with other utilities like the Sacramento Municipal Utility District, and with support from industry, state and federal resources, to devise ways to assess and address change and enable cost-effective transformation strategies for electric customers. The Proactive Approach does not solve all the issues but hopefully it can provide the beginnings of a consistent framework and systemic process to organize data, prioritize through establishing thresholds, perform evaluations with appropriate models and communicate findings to inform decision-making

## **APPENDICES**

Appendix A: Supporting industry and utilities perspective for Proactive Approach

Appendix B: RSWG PV Subgroup description of Proactive Approach

Appendix C: Cluster Evaluation Methodology

Appendix D: Circuit Evaluation and Selection

Appendix E: Draft Proactive Analysis Results

Appendix F: Proactive Approach for High Penetration PV Cluster/Circuit Analysis & Mitigation Assessment

## Appendix A: Supporting industry and utilities perspective for Proactive Approach

### Industry Expertise providing comments (Through Report 3 only)

- Elaine Sison-Lebrilla is a Senior Project Manager at the Sacramento Municipal Utility District (SMUD). She has over 25 years of professional experience in the energy and electrical engineering arena. At SMUD, she oversees the Renewable Energy Program for the Energy Research and Development Department with responsibility for activities related to growing the SMUD's renewable energy supply to 37% by 2020. She leads the renewable procurement, geothermal and small hydroelectric generation activities for the department. She also plans, organizes, and directs renewable generation and integration research, development and demonstration (RD&D) projects to meet the needs of SMUD. She leads SMUD's efforts in the High Penetration PV Initiative funded under the California Solar Initiative (CSI) Research, Development, Demonstration, and Deployment (RD&D) Program. She also represents SMUD on the Utility Advisory Team for HECO's Distributed Resource Energy Analysis and Management System Development for Real-Time Grid Operations (DREAMS) project funded by the Department of Energy. Previous to SMUD, Ms. Sison-Lebrilla worked for the California Energy Commission as Manager of the Geothermal Program and the Energy Generation Research Office under the Public Interest Energy Research Program. Ms. Sison-Lebrilla has a Bachelor of Science degree in Electrical Engineering from University of California at Berkeley and is a California registered Professional Engineer.
- Daniel Brooks manages the Grid Operations, Planning and Bulk Variable Generation Integration research group of the Power Delivery and Utilization Sector at the Electric Power Research Institute (EPRI). In this position, he manages and conducts power systems engineering analytical studies of transmission, distribution, generation, and system operations. His current personal research focuses on system impacts of wind integration, development of generator and load dynamic models for planning studies, consideration of energy efficiency and demand response in T&D planning, and the impacts of integrating distributed resources including plug-in electric hybrid vehicles on existing utility distribution operations. Brooks joined EPRI in 2004 as Manager of Wind Integration Studies. In addition to wind studies, he has conducted various operations and planning simulation studies including power flow, transient stability, electromagnetic transients, unit commitment, and long-term dynamics. Before joining EPRI, Brooks worked for Electrotek Concepts, managing and conducting similar modeling and simulation studies, as well as power quality investigations. Brooks received his Bachelors and Masters degrees in electrical engineering from Mississippi State University in 1993 and 1994, respectively, and his Masters in Business Administration degree from the University of Tennessee, Martin in 2001. He is a Registered Professional Engineer in the state of Tennessee and is a Senior Member of the IEEE Power Engineering Society.
- Tom Key is a Senior Technical Executive at the Electric Power Research Institute. He has over 30 years experience in energy related R&D in the US Navy, at Sandia National Laboratory in Albuquerque, and at EPRI. He currently manages EPRI renewable generation integration activities. His key areas of study are the photovoltaic and electronic inverter performance, utility ownership models for solar, analysis and tools to understand integration of distributed

generation into the electric distribution system. Prior to assuming his current position at EPRI, Key was manager of renewable generation at EPRI and Vice President of Technology at EPRI Solutions (a former wholly-owned subsidiary of EPRI). He is a founder of EPRI's laboratory for power quality, distributed generation and end-use applications in Knoxville, Tennessee. Prior to his EPRI career, Key was Manager of RDT&E for a utility grid-compatible interface at Sandia National Laboratories. His work included characterizing high-performance dc/ac inverters and electronic appliances, analyzing effects of power disturbances on sensitive electronic equipment, and developing design criteria and recommended practices for cost-effective application of power-enhancement equipment. Key holds a Master's degree in electrical power engineering & management from Rensselaer Polytechnic Institute 1974 and a Bachelor's degree in electrical engineering from the University of New Mexico 1970. Key is a Fellow of the IEEE and nationally recognized in power system compatibility research, integration of distributed and renewable energy resources, and application of energy storage and power electronic technologies. He has published more than 150 publications and presented at numerous conferences, forums, and given testimony to the House Committee on Science and Technology Hearing on Energy Storage Technologies.

- Jeff Smith is a Senior Project Manager in the Power System Studies Group at EPRI. His current area of focus is transmission and distribution analysis and planning as it pertains to renewable resources, including: Photovoltaic (PV) modeling for distribution and transmission studies, advanced inverter control for high-penetration PV, and distribution planning with distributed resources. Mr. Smith joined EPRI in 2004 as a Project Manager in the System Studies Group, where his activities focused on power quality analysis, insulation coordination, and wind interconnection studies. He also developed a novel mathematical model of the transmission ultracapacitor. Before joining EPRI, Mr. Smith was a Senior Power Systems Engineer at Electrotek Concepts Inc., where his primary responsibilities were focused on power system studies including: power quality, distribution planning with distributed generation, and bulk transmission studies. However, the majority of his efforts were focused on engineering studies related to bulk wind interconnection and integration. Mr. Smith is currently the WG Convener for CIGRE C4/C6.29 "Power Quality Aspects of Solar Power", currently a member of the WECC Renewable Energy Modeling Task Force. and was previously vice-chair of the IEEE Working Group on Dynamic Performance of Wind Power Generation Committee. Mr. Smith received a Master's Degree in Electrical Engineering in 1998 from Mississippi State University where he specialized in electric machine modeling for transient and stability analyses and evaluation of voltage flicker measurement algorithms. Mr. Smith also received his Bachelor's Degree in Electrical Engineering in 1996 from Mississippi State University.
- Mr. Vikas Singhvi is a Sr. Project Engineer/Scientist in Grid Operation and Planning Group of the Power Delivery & Utilization Sector at EPRI. His current research activities focus on transmission system modeling and simulation. He has performed numerous reliability and impact studies for systems falling under SPP, PJM, MISO and NYISO footprints. He has also performed studies related to power transfer capability, load deliverability, reactive power requirements and system optimization. Formerly, he served as a Consultant engineer at Siemens Power Technologies International (PTI). At Siemens, he provided analytical network consulting to client including utilities, independent power producers, merchant developers and research institutions. He is an advanced user of Siemens Power Technologies (PTI) Power System Simulator for Engineering (PSS E) software. Mr. Singhvi's other areas of interest includes

Modeling and simulation of new technologies such as Plug-in-hybrid Electric Vehicles (PHEV), photovoltaic (PV) and battery storage and evaluate their impacts on the power system grid; Mr. Singhvi received a Bachelor of Engineering in Electrical Engineering in 2001 from Engineering College, Jodhpur, India and Master of Science in Electrical Engineering in 2002 from Mississippi State University. He is a Member of the IEEE PES and IAS Society.

- Ben York is a Senior Project Engineer in EPRI's Distributed Energy Resource program area, and is a principle investigator and technical coordinator for EPRI's Integrated Grid concept. Ben's primary research area is distributed resource integration, focusing on both technical and economic issues. Outside of this effort, Ben currently contributes to several focus areas, including power electronics, photovoltaic balance-of-systems, and microgrid technologies. He is a published author in multiple industry journals on power electronics design and control. Before joining EPRI in 2013, Ben was a Research Assistant at Virginia Tech's Future Energy Electronics Center. Ben was responsible for research, development, and demonstration of several products directly related to photovoltaic energy conversion, including the development of a new distributed power electronic interface for PV as part of a multi-year Department of Energy award. Ben received a B.S. (2008) degree in electrical engineering from the University of Alabama, as well as M.S. (2010) and Ph.D. (2013) degrees in electrical engineering from Virginia Tech.

Powering forward. Together.



June 30, 2014

Dora Nakafuji  
Renewable Energy Planning Director  
Hawaiian Electric Company  
900 Richards Street  
Honolulu, HI 96813

Dear Dora,

Thank you for the opportunity to provide comments on the Cluster Evaluation Methodology. The methodology has provided us with an effective tool to check the status of our circuits and plan for anticipated increase in PV generation. We have used this tool on our EG substation and associated feeders resulting in good insight on possible reliability issues. We plan to utilize this methodology on other circuits to test mitigation measures. Although our PV penetrations are not at a level as that of HECO, our areas of concern are growing.

SMUD generates, transmits and distributes electricity to a 900-square-mile territory that includes California's capital city, Sacramento County, CA and a small portion of the Placer County, CA. SMUD has long been a leader in both energy efficiency and renewable energy, considered to be one of the most progressive utilities in the nation, while demonstrating that clean energy can be delivered at an affordable rate without compromising reliability. SMUD received about 24% of its energy from renewable resources in 2010, being the first large California utility to meet the 20% by 2010 Renewable Portfolio Standard (RPS) goal. SMUD also has a 33% by 2020 RPS goal and a Solar Initiative Incentive program goal of 125 MW of solar generation by 2016. In addition, SMUD anticipates installation of 100MW of PV Systems by the end of 2012 contracted under our Feed-In Tariff program. All of these efforts contribute to our long term carbon reduction goal of 90% below 1990 levels by 2050. SMUD expects the integration of high penetrations of variable renewable DG energy (i.e. solar) to be a challenge in the near future as we pursue SMUD's ambitious goals.

Sincerely,

A handwritten signature in blue ink that reads "Elaine Sison-Lebrilla".

Elaine Sison-Lebrilla  
Renewable Energy Program Manager  
Energy Research & Development Department  
Sacramento Municipal Utility District

SMUD HQ | 6201 S Street | P.O. Box 15830 | Sacramento, CA 95852-1830 | 1.888.742.7683 | smud.org





## EPRI Feedback for Hawaiian Electric's Proactive Methodology

1. **Proposed methodology is a good example of a planning approach**, informing distribution engineers as to which feeders have reached their hosting capacity limit, and how much more margin they have left. This methodology is more extensive than the vast majority of utility methods proposed to date. It correctly points out that hosting capacity and feeder peak load level do not necessarily correspond. In some respects, this method is similar to EPRI's detailed hosting capacity methodology that has been applied to feeders throughout the US. We have also discovered an opportunity to develop similar simplified screening methods, but derived from more detailed analyses, and we are currently developing these methods as part of EPRI research portfolio and with funding from the CPUC (CSI-3).
2. **Evaluation criteria are appropriate** and include LTC operation, voltage limits, and protection. (EPRI also selected the same criteria in our analysis).
3. **We recommend adding more detail about bulk system analysis methods to help inform the reader.** For instance, it could be helpful to divide "dynamic analysis" at the bulk system into "long-term dynamics" and "system stability." It is also unclear as to the connection between the distribution screening results and that of the bulk system. Finally, the difference between "time-domain transient simulations," the kind that would be done in EMTP, and "dynamic analysis" could be better explained. Also more detail on the bulk system models would be useful. PV inverter outputs and aggregation, load modeling, solar irradiance profiles, etc, would be useful to see. Explain how time-varying profiles will be handled in PSS/E. For thermal overloading, what types of ratings were used – Long-term emergency (Rate B) or Short-term emergency (Rate C)?
4. **While the bulk system analysis shown in the report is a good beginning, additional work may be necessary in order to draw more definitive conclusions.** The most pressing being a more detailed discussion of economic dispatch and unit commitment, issues of voltage stability, revenue sufficiency, long-term planning reserve margin, and others would be helpful to consider. Depending on the anticipated scope of the work, this may or may not be important to address at this time.
5. **The term "Grid Impact Factor" needs to be more clearly defined.** We believe it may be difficult to use just one factor give all the variables. On the other hand, simplified methods are a good idea. HECO and EPRI should compare notes on ways to do this, see #1 above.
6. **Even though this is a planning study, it would be prudent to compare the results to a more detailed analysis as a method of validation.** This would provide a more conclusive verification of the methods used in the study.
7. **It would be beneficial to set expectations for the methodology at the outset.** This is purely a planning methodology, not to replace more detailed interconnection studies. More detailed studies will be required as PV penetration reaches the feeders' planning limits.

## Appendix B: RSWG PV Subgroup Description of Proactive Approach

Excerpt from **FINAL REPORT OF THE PV SUB-GROUP FOR THE RELIABILITY STANDARDS WORKING GROUP Docket No. 2011-0206**

The PV Sub-Group has worked collaboratively to develop a first-of-its-kind utility Proactive Approach that responds directly to the Commission’s request to explore how HECO can utilize PV production data to streamline the screening process such that “greater penetration of PV systems is possible.”<sup>13</sup> The Proactive Approach proposal (Attachment 17) coordinates, and mutually enhances, HECO’s interconnection and distribution and transmission planning functions. As shown in the image below, which is taken from Attachment 17, the Proactive Approach is a large step forward in refining Hawaii’s interconnection procedures:

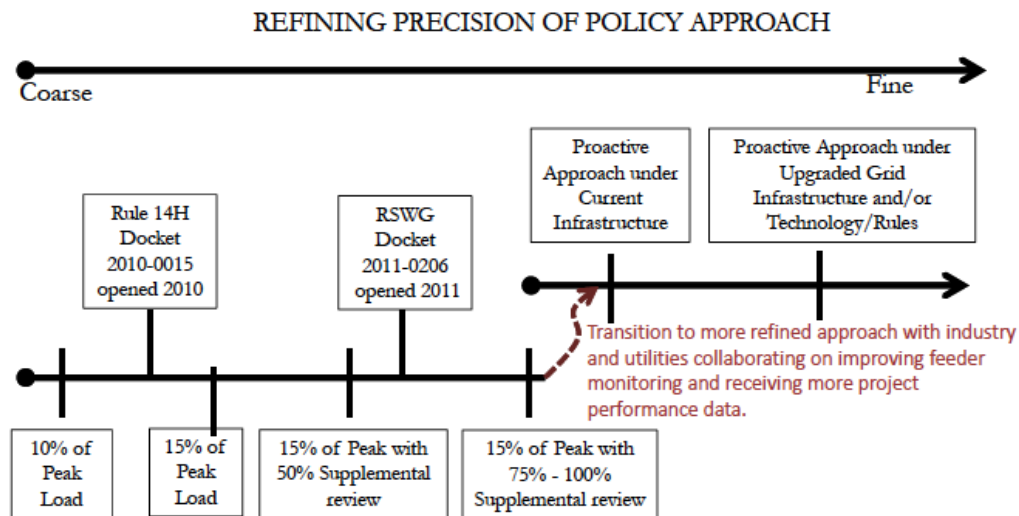

HECO will utilize the interconnection queue and other data points to establish a reasonable base case of anticipated DG development. Through its distribution and transmission planning effort, it will proactively plan for the aggregate system impacts from expected DG development in order to accommodate higher penetration levels. The coordination of interconnection and planning will identify opportunities where infrastructure upgrades can accommodate both DG and load such that a number of generators and customers can benefit from the upgrades.

Specifically, HECO will employ enhanced tools for modeling DG to inform both system and distribution-level planning and operations. Those models will leverage PV production data from individual DG systems, which members of the PV industry recently made available to HECO, to supplement utility monitoring tools. This improved modeling capability will, in turn, enhance a number of areas related to the interconnection of high penetrations of DG, including:

- Assessing potential system and region-level impacts due to high penetrations;
- Evaluating impacts to dispatch and generation, reserve planning, and response to ramping events;
- Informing and streamlining the distribution level interconnection process; and
- Helping to identify circuit penetration capabilities, potential issues, and necessary upgrades.

The overall goal of this collaborative approach is to create a more transparent and efficient process for interconnecting higher levels of DG while maintaining safety, reliability, and power quality across the transmission and distribution infrastructure. The approach will benefit all parties involved, including customers, developers and utilities, as well as the broader public.